

Inobitec Web DICOM Viewer version 2.10

USER'S MANUAL

The screenshot displays the Inobitec Web DICOM Viewer interface. At the top, there is a navigation bar with the logo and a search bar labeled "Name" with a dropdown arrow and a text input field "Enter a request". Below this is a toolbar with icons for file operations, zooming, and viewing. The main area shows a 3D skull model with a heatmap overlay, surrounded by 2D axial, sagittal, and coronal slices. A large blue arrow points to a vertical toolbar with icons for zooming and a "LAO" button. A "SAVE" button is visible near the 3D model. A histogram is shown in the bottom right corner.

SYNCH
BY POINT
FOR MPR
AND 3D

REPORT CREATION

STUDY LINK CREATION
[/image?link=](#) TO OPEN/DOWNLOAD/ANONYMIZED

HISTOGRAM DISPLAY
FOR IMAGE AND ROI



The information contained in this User Manual belongs to Inobitec Software FZ-LLC, Dubai Media City, Building 05, Dubai, UAE, P.O. Box 73030. The Manual is delivered to the users of «Inobitec Web DICOM Viewer» software product exclusively for the purpose of working with this product. No part of the information contained herein can be modified, used for any other purpose or delivered to any third party without the prior written consent of Inobitec Software FZ-LLC. Inobitec Software FZ-LLC reserves the right to alter this Manual without prior notice.

Contents

| | |
|----------------------------------------------------------|-----------|
| Contents | 3 |
| About this Manual | 4 |
| Accepted Conventions | 4 |
| Technical Support | 5 |
| About the Product | 6 |
| Web DICOM Viewer Functionality | 7 |
| Getting Started | 16 |
| 1 Login to the Web DICOM Viewer | 17 |
| 1.1 Login | 17 |
| 1.2 Tutorial and Usermanual | 19 |
| 1.3 Version of Web DICOM Viewer | 19 |
| 2 The Web DICOM Viewer Settings | 21 |
| 2.1 User Settings Menu | 21 |
| 2.2 General settings | 22 |
| 2.3 Configuring the Connection to PACS Servers | 23 |
| 2.4 Hotkeys | 26 |
| 2.5 Security | 27 |
| 2.6 Links Table | 27 |
| 2.7 Tables | 29 |
| 2.7.1 Customizing Parameters Display Options | 29 |
| 2.7.2 Sorting by Values | 30 |
| 2.7.3 Table Context Menu | 30 |
| 3 Program Window Elements | 31 |
| 3.1 Toolbar | 31 |
| 3.2 Select Data Source | 33 |
| 3.3 Search panel | 33 |
| 3.3.1 Setting Dates in the Calendar | 36 |
| 3.4 Study Panel | 37 |
| 3.4.1 Uploading Studies | 38 |
| 3.4.2 Downloading Studies | 38 |
| 3.5 Series Panel | 39 |

| | | |
|----------|---------------------------------------------------------------------------|-----------|
| 3.6 | View Images | 41 |
| 3.7 | View Multiple Series | 43 |
| 3.7.1 | Auto Mode | 43 |
| 3.7.2 | Stacked Mode | 44 |
| 3.7.3 | Grid Mode | 44 |
| 3.8 | Cancelling Tool Actions | 45 |
| 3.9 | Tool Control Buttons | 46 |
| 3.10 | Context menu | 46 |
| 3.11 | Sorting images | 47 |
| 4 | View Flat Images | 48 |
| 4.1 | View Images in a Series | 48 |
| 4.2 | Play images | 48 |
| 4.3 | Zoom, Move, Rotation | 49 |
| 4.3.1 | Zoom | 49 |
| 4.3.2 | Move | 50 |
| 4.3.3 | Rotation | 50 |
| 4.4 | Set Window Level and Width | 51 |
| 4.4.1 | Change W/L Tool | 51 |
| 4.4.2 | Selecting Preset Window Width and Level Values | 52 |
| 4.4.3 | W/L Settings Dialog Box | 52 |
| 4.4.4 | Changing Hotkeys for Presets | 53 |
| 4.4.5 | Histogram | 55 |
| 4.4.6 | Histogram for ROI | 55 |
| 4.5 | Magnifier | 56 |
| 4.6 | Measurements | 57 |
| 4.6.1 | Distance measurement ruler | 58 |
| 4.6.2 | Distance measurement polyline | 59 |
| 4.6.3 | Angle measurement | 59 |
| 4.6.4 | Point ROI measurement | 60 |
| 4.6.5 | Measure the Intensity Average and Standard Deviation in an Area | 60 |
| 4.6.6 | Cobb angle meter | 61 |
| 4.6.7 | Drawing Parameters | 61 |
| 4.6.8 | Editing Measurements | 62 |
| 4.6.9 | Move Measurements | 62 |
| 4.6.10 | Moving the measurement data | 62 |
| 4.6.11 | Delete Measurements | 62 |
| 4.7 | Graphic Label Tools | 63 |
| 4.7.1 | General | 63 |
| 4.7.2 | Graphic Label Tool | 63 |
| 4.7.3 | Editing Annotations | 64 |
| 4.7.4 | Actions with Labels | 65 |
| 4.8 | Mirror Image Horizontally/Vertically | 65 |
| 4.9 | Calibration sizes | 65 |
| 4.10 | Synchronization by a Point | 67 |
| 4.11 | Image Synchronization | 67 |
| 4.12 | Visualize Images | 68 |
| 4.13 | Scout Lines | 68 |

| | | |
|----------|--------------------------------------------------------------|-----------|
| 4.13.1 | The Tool Menu | 69 |
| 4.13.2 | Line Settings | 70 |
| 4.14 | Set Up Viewer Workspace | 70 |
| 4.14.1 | Orientation Cube | 71 |
| 4.14.2 | Scale | 72 |
| 4.14.3 | Image Information | 72 |
| 4.14.4 | Patient Information | 72 |
| 4.15 | Viewing PDF documents | 72 |
| 4.16 | View DICOM Tags | 73 |
| 4.16.1 | DICOM Tags. General Information | 73 |
| 4.16.2 | DICOM Tag Viewer Window | 74 |
| 4.16.3 | Toolbar | 76 |
| 4.16.4 | Tag Tree | 77 |
| 4.16.5 | Search | 78 |
| 4.17 | Viewing Structured Reports | 78 |
| 4.17.1 | General Information about Structured Reports | 78 |
| 4.17.2 | Structured Reports Viewer Window | 78 |
| 4.17.3 | «Search» Field | 80 |
| 4.18 | Watching Videos | 81 |
| 4.19 | Export series | 82 |
| 4.19.1 | Export to DICOM | 82 |
| 4.19.2 | Export to Image | 83 |
| 5 | Volume Reconstruction | 85 |
| 5.1 | Viewing Series in the Volume Reconstruction Window | 85 |
| 5.2 | Model Orientation in Space | 86 |
| 5.3 | Model Positioning Tools | 86 |
| 5.4 | Measurement tools | 86 |
| 5.4.1 | Distance measurement ruler tool | 87 |
| 5.4.2 | Distance measurement polyline tool | 87 |
| 5.4.3 | Angle measurement tool | 87 |
| 5.5 | Model Playing | 87 |
| 5.6 | Visualization Settings | 87 |
| 5.7 | Cutting Tools | 87 |
| 5.7.1 | Undo and Redo tools | 88 |
| 5.7.2 | Polygonal cut | 88 |
| 5.7.3 | Inverse polygonal cut | 89 |
| 5.7.4 | Remove table tool | 89 |
| 6 | Multiplanar Reconstruction (MPR) | 90 |
| 6.1 | View Images | 90 |
| 6.2 | Reconstruction Modes. Slice Thickness | 91 |
| 6.2.1 | Render Modes | 91 |
| 6.2.2 | Slice Thickness | 91 |
| 6.3 | Working with Orthogonal Planes | 92 |
| 6.3.1 | View navigation modes | 92 |
| 6.4 | Curvilinear Reconstruction. Build Surface | 94 |
| 6.4.1 | Curve settings | 95 |

| | | |
|-----------|-----------------------------------------------------------|------------|
| 6.4.2 | Actions with a Curve | 97 |
| 6.5 | Measurements | 97 |
| 6.6 | Annotations | 98 |
| 6.7 | Calibration | 98 |
| 7 | ECG Viewer | 99 |
| 7.1 | View Graphs | 99 |
| 7.2 | Toolbar | 99 |
| 7.2.1 | ECG Speed | 99 |
| 7.2.2 | Scale | 99 |
| 7.2.3 | Length Interval | 100 |
| 7.2.4 | Value Interval | 100 |
| 7.2.5 | Set Up Coordinate Plane | 101 |
| 7.3 | Frequency Filters | 101 |
| 7.4 | Export series | 101 |
| 8 | Creating Links for Viewing Studies | 102 |
| 8.1 | Creating a Link from the Study List | 102 |
| 8.2 | Creating a link from the Viewer Tab | 105 |
| 8.3 | Restrictions on Viewing Studies via Links | 106 |
| 9 | Report Editor | 108 |
| 9.1 | Editor Window | 109 |
| 9.1.1 | Toolbar | 109 |
| 9.1.2 | Text Editing Tools | 110 |
| 9.2 | Actions with the Reports | 113 |
| 9.2.1 | Creating an Empty Report | 113 |
| 9.2.2 | Saving a Report | 114 |
| 9.2.3 | Exporting a Report | 114 |
| 9.2.4 | Viewing and Editing a Report | 114 |
| 9.2.5 | Creating a Report on the Basis of a Template | 115 |
| 9.3 | Report Template | 115 |
| 9.3.1 | Creating an Empty Template | 115 |
| 9.3.2 | Creating a Template in the Report Editor Window | 116 |
| 9.3.3 | Viewing and Editing the Report Template | 116 |
| 9.3.4 | Saving a Report Template | 117 |
| 9.3.5 | Deleting a Report Template | 117 |
| 10 | Licensing | 118 |
| 10.1 | Personal User Licenses | 118 |
| 10.2 | Concurrent licenses | 118 |
| 10.3 | Unified User Licensing | 118 |

About this Manual

This User Manual describes the functionality of «Inobitec Web DICOM Viewer» (version 2.10) and provides instructions on how to use this software product.

Accepted Conventions

Names of program interface elements, key names and important notes are printed in **bold**.
Image captions are printed in *italics*.

Technical Support

Technical support of «Inobitec Web DICOM Viewer» users is provided by the Inobitec Software FZ-LLC team. If you apply for technical support, please include the following information in your message:

- the name, version and bitness of the operating system of the computer(s) on which the software server components are installed (you can get this information from your system administrator);
- your operating system version from which a client connects to the server (you can get this information from your system administrator);
- product version. The program version is specified in the **About** section of the user's menu. For details, see Section 1.3.

To apply for technical support, or if you have any further questions or comments, please email us at support@inobitec.com

About the Product

The «Inobitec Web DICOM Viewer» software product is intended for viewing, analyzing and printing medical data obtained from various DICOM equipment (modality). The product is deployed on diagnostic workstations and integrated with PACS servers. The Web DICOM Viewer propels the capabilities of diagnostics to a new level and makes it possible to detect pathological conditions timely and efficiently, predict their development and plan their elimination.

For the purpose of establishing a diagnosis, «Inobitec Web DICOM Viewer» software must only be used by properly qualified personnel.



Making a diagnosis is not allowed when the Web DICOM Viewer is running on mobile devices.

The «Inobitec Web DICOM Viewer» software product and installer does not:

- collect and transfer confidential user information;
- intercept network traffic;
- show ads;
- send spam;
- show messages not related to work;
- automatically update itself without notifying the user.

After uninstalling you do not need to restore your operating system and browser settings. Uninstalling is free of charge. Uninstalling does not adversely affect the operation of the computer and installed software. Files not related to the Web DICOM Viewer are not removed and changed after uninstalling.

For details on the structure of «Inobitec Web DICOM Viewer» package, its installation, launch, licensing, setting up and integration with PACS servers, see the **Admin's Manual**.

License Agreement is available from the link inobitec.com/eng/about/webviewerLic/.

Web DICOM Viewer Functionality

INOBITEC Products Comparison Table

| Web DICOM Viewer features and tools | Lite | Pro | Web |
|------------------------------------------------------------------------|-------------|------------|------------|
| General functions | ✓ | ✓ | ✓ |
| Multilingual user interface | ✓ | ✓ | ✓ |
| Autorun of the application | ✓ | ✓ | |
| Support for multiple monitors | ✓ | ✓ | |
| High resolution monitor support | ✓ | ✓ | ✓ |
| Full-screen mode | ✓ | ✓ | ✓ |
| Minimize application window to system tray | ✓ | ✓ | |
| Open/save file using Native OS dialogs | ✓ | ✓ | |
| Hotkeys | ✓ | ✓ | ✓ |
| Control of tools with different mouse buttons (left, right, or middle) | ✓ | ✓ | ✓ |
| Export and import settings | ✓ | ✓ | |
| Integrated help system | ✓ | ✓ | ✓ |
| Displaying phases | ✓ | ✓ | ✓ |
| Viewing structured reports (SR) | ✓ | ✓ | ✓ |
| Viewing DICOM tags | ✓ | ✓ | ✓ |
| Viewing PDF documents | ✓ | ✓ | ✓ |
| Support for voxel rendering | ✓ | ✓ | ✓ |
| Support for polygonal rendering | | ✓ | |
| Showing the patient's name on the tab stub | ✓ | ✓ | ✓ |
| Displaying labels for images of the series and 3D reconstruction | ✓ | ✓ | ✓ |
| Highlighting tag labels and other information | ✓ | ✓ | |
| Remote viewing with restricted functionality via the Web browser | | ✓ | |
| Integration with third-party systems | ✓ | ✓ | ✓ |
| Launching the program from the command line with parameters | ✓ | ✓ | |
| Executing commands via URL using the protocol inobitec:// | ✓ | ✓ | |

| Web DICOM Viewer features and tools | Lite | Pro | Web |
|------------------------------------------------------------------------|-------------|------------|------------|
| HTTP RPC service | ✓ | ✓ | |
| Opening a study by a link | | | ✓ |
| Basic measuring tools for series images and MPR slices | ✓ | ✓ | ✓ |
| Ruler | ✓ | ✓ | ✓ |
| Polygonal ruler | ✓ | ✓ | ✓ |
| Angle | ✓ | ✓ | ✓ |
| Cobb angle | ✓ | ✓ | ✓ |
| Point value | ✓ | ✓ | ✓ |
| ROI ellipse | ✓ | ✓ | ✓ |
| ROI rectangle | ✓ | ✓ | ✓ |
| ROI polygon | ✓ | ✓ | ✓ |
| Histogram display for ROI | ✓ | ✓ | ✓ |
| Measurement of speed and time interval for dopplergram | ✓ | ✓ | |
| Distance measurement on ultrasound studies | ✓ | ✓ | |
| Angle measurement between the rulers | | ✓ | |
| Annotation tools for series images and MPR slices | ✓ | ✓ | ✓ |
| Ellipse | ✓ | ✓ | ✓ |
| Polygon | ✓ | ✓ | ✓ |
| Arrow | ✓ | ✓ | ✓ |
| Text | ✓ | ✓ | ✓ |
| Pencil | ✓ | ✓ | ✓ |
| Special tools | ✓ | ✓ | ✓ |
| Calibrating image sizes | ✓ | ✓ | ✓ |
| Digital Subtraction Angiography (DSA) | ✓ | ✓ | |
| Calcium scoring | | ✓ | |
| Cardiothoracic ratio tool | | ✓ | |
| Measurement of apparent diffusion coefficient (ADC) | | ✓ | |
| Blood flow parameters evaluation on the basis of phase-contrast images | | ✓ | |
| Visualization of Diffusion Tensor Imaging (DTI) | | ✓ | |
| Fusion on the basis of differentiating color contrasting of series | | ✓ | |

| Web DICOM Viewer features and tools | Lite | Pro | Web |
|----------------------------------------------------------------|-------------|------------|------------|
| Image stitching | | ✓ | |
| Processing of display of series images and MPR slices | ✓ | ✓ | ✓ |
| Zoom | ✓ | ✓ | ✓ |
| True size | ✓ | ✓ | |
| Pan | ✓ | ✓ | ✓ |
| Magnifier | ✓ | ✓ | ✓ |
| Rotate | ✓ | ✓ | ✓ |
| Flip image | ✓ | ✓ | ✓ |
| Adjust W/L | ✓ | ✓ | ✓ |
| W/L settings | ✓ | ✓ | ✓ |
| Full dynamic W/L | ✓ | ✓ | |
| Custom W/L presets | ✓ | ✓ | |
| CLUTs | ✓ | ✓ | ✓ |
| User CLUTs | ✓ | ✓ | |
| Support for color lookup tables (CLUTs) embedded in DICOM data | ✓ | ✓ | |
| Choose image resampling filter | ✓ | ✓ | |
| Image filters (sharpen, blur, median) | | ✓ | |
| Video recording and playback | ✓ | ✓ | ✓ |
| Play images | ✓ | ✓ | ✓ |
| Choosing a playback speed | ✓ | ✓ | ✓ |
| Playback looping | ✓ | ✓ | ✓ |
| Play video contained in DICOM files | | | ✓ |
| Video recording | | ✓ | |
| Choosing an encoder for video recording | | ✓ | |
| Export images | ✓ | ✓ | ✓ |
| View screenshot | ✓ | ✓ | ✓ |
| Visible image screenshot | ✓ | ✓ | |
| Raw image data capturing | ✓ | ✓ | |
| Export images to a new series of DICOM images | ✓ | ✓ | ✓ |

| Web DICOM Viewer features and tools | Lite | Pro | Web |
|------------------------------------------------------------------|-------------|------------|------------|
| Export images to a graphic file (JPEG, PNG) | ✓ | ✓ | |
| Opening DICOM studies from various sources | ✓ | ✓ | ✓ |
| Opening DICOM studies from a folder | ✓ | ✓ | ✓ |
| Opening DICOM studies from a PACS server | ✓ | ✓ | ✓ |
| Opening DICOM studies from a local storage | ✓ | ✓ | ✓ |
| Opening DICOM studies from zip archives | ✓ | ✓ | |
| DICOMDIR reading | ✓ | ✓ | |
| Loading images in the background | ✓ | ✓ | ✓ |
| Work with DICOM studies | ✓ | ✓ | ✓ |
| Uploading to the PACS server with storeSCU | ✓ | ✓ | ✓ |
| Downloading from the PACS server with C-GET and C-MOVE | ✓ | ✓ | ✓ |
| Work as a PACS server, support C-FIND, C-MOVE and C-STORE | ✓ | ✓ | |
| Export studies and series to the folder | ✓ | ✓ | ✓ |
| Export studies and series to the zip archive | ✓ | ✓ | ✓ |
| Search for studies | ✓ | ✓ | ✓ |
| Saving the search parameters | ✓ | ✓ | |
| Editing patient name and discription of study in local storage | ✓ | ✓ | |
| Anonymize studies and series with the ability to edit DICOM tags | ✓ | ✓ | |
| Downloading from the PACS server via WADO | ✓ | ✓ | |
| The support of secure connection with TLS | | ✓ | |
| View images | ✓ | ✓ | ✓ |
| Customized split screen | ✓ | ✓ | ✓ |
| Displaying several studies at the same time | ✓ | ✓ | ✓ |
| Scrolling images | ✓ | ✓ | ✓ |
| Opening series from the context menu | ✓ | ✓ | ✓ |
| Customized arrangement depending on the study modality | ✓ | ✓ | |
| Automatic filling of windows with study series | ✓ | ✓ | |
| Building orthogonal projections | ✓ | ✓ | |

| Web DICOM Viewer features and tools | Lite | Pro | Web |
|------------------------------------------------------------------------------|-------------|------------|------------|
| Merge series into a multiphase series | ✓ | ✓ | |
| Data synchronization | ✓ | ✓ | ✓ |
| Synchronizing Window / Level for images | ✓ | ✓ | ✓ |
| Synchronize moving and zooming for images | ✓ | ✓ | ✓ |
| Synchronizing the image change | ✓ | ✓ | ✓ |
| Synchronization modes (automatic and manual synchronization) | ✓ | ✓ | ✓ |
| 3D cursor | ✓ | ✓ | ✓ |
| Displaying slice projections | ✓ | ✓ | ✓ |
| Synchronization of MPR tabs on different monitors | ✓ | ✓ | |
| MPR | ✓ | ✓ | ✓ |
| Viewing axial, frontal, and sagittal sections | ✓ | ✓ | ✓ |
| Rotate cutting planes | ✓ | ✓ | ✓ |
| Setting MPR modes (Average, MIP, MinIP) | ✓ | ✓ | ✓ |
| Set slice thickness | ✓ | ✓ | ✓ |
| Display of MPR planes on 3D model | ✓ | ✓ | |
| Customizing windows arrangement | | ✓ | |
| Export sections of any of the planes with a selectable increment to a series | | ✓ | |
| Fusion on the basis of differentiating color contrasting of series | | ✓ | |
| Viewing Diffusion Tensor Imaging series (DTI) | | ✓ | |
| Curvilinear reconstruction | | ✓ | ✓ |
| Curve slices | | ✓ | |
| Basic editing tools for a 3D model | ✓ | ✓ | ✓ |
| Canceling and reverting changes | ✓ | ✓ | ✓ |
| Polygon cut | ✓ | ✓ | ✓ |
| Inverse Polygon Cut | ✓ | ✓ | ✓ |
| Cut object | ✓ | ✓ | |
| Cut all except object | ✓ | ✓ | |
| Measuring tools for a 3D model | ✓ | ✓ | |
| Ruler | ✓ | ✓ | ✓ |

| Web DICOM Viewer features and tools | Lite | Pro | Web |
|-----------------------------------------------------------------------------------------|-------------|------------|------------|
| Polygonal ruler | ✓ | ✓ | ✓ |
| 3D Angle | ✓ | ✓ | ✓ |
| Surface ruler | | ✓ | |
| Markers for MPR and 3D reconstruction | ✓ | ✓ | |
| Point marker | ✓ | ✓ | |
| Line marker | ✓ | ✓ | |
| Polygonal line marker | ✓ | ✓ | |
| Volume reconstruction (3D) | ✓ | ✓ | ✓ |
| MIP (Maximum Intensity Projection) | ✓ | ✓ | |
| Clipping box | ✓ | ✓ | |
| Switching standard projections | ✓ | ✓ | ✓ |
| Switching the projection type (parallel and perspective projections) | ✓ | ✓ | |
| Remove bones | ✓ | ✓ | |
| Remove table | ✓ | ✓ | ✓ |
| Center of model | ✓ | ✓ | |
| Setting render quality of the model | ✓ | ✓ | |
| Export of several images obtained by rotating the model to a graphic file (jpg, png) | ✓ | ✓ | |
| Export of several images obtained by rotating the model to a new series of DICOM images | ✓ | ✓ | |
| Deleting bone structures with the help of a native series | | ✓ | |
| Segmentation | | ✓ | |
| Showing the editing mask and its outline | | ✓ | |
| Canceling and reverting changes | | ✓ | |
| Polygon cut | | ✓ | |
| Inverse polygon cut | | ✓ | |
| Cut object | | ✓ | |
| Cut all except object | | ✓ | |
| Brush cut | | ✓ | |
| Brush restore | | ✓ | |

| Web DICOM Viewer features and tools | Lite | Pro | Web |
|-----------------------------------------------------------|-------------|------------|------------|
| Brush opening operation | | ✓ | |
| Brush closing operation | | ✓ | |
| Segmentation from point by mask | | ✓ | |
| Region growing | | ✓ | |
| Vessel tree segmentation | | ✓ | |
| Watershed segmentation | | ✓ | |
| Region growing of segmented structures | | ✓ | |
| Contour segmentation | | ✓ | |
| Boolean operations with structures | | ✓ | |
| Grow/Shrink | | ✓ | |
| Creating a surface with a mask | | ✓ | |
| Export surface (PLY, OBJ, STL, GLB) | | ✓ | |
| Import surface (PLY, OBJ, STL) | | ✓ | |
| Series fusion | | ✓ | |
| Stitch images | | ✓ | |
| Volume stitching with different modality/intensity ranges | | ✓ | |
| Export of volume stitching | | ✓ | |
| Series fusion from one study | | ✓ | |
| Series fusion from different studies | | ✓ | |
| Subtracting images | | ✓ | |
| Fit layers by points | | ✓ | |
| Merge layers automatically | | ✓ | |
| Merge layers manually | | ✓ | |
| Image registration | | ✓ | |
| Recording a study on a CD/DVD | ✓ | ✓ | |
| Recording data to CD/DVD | ✓ | ✓ | |
| Recording a study on a USB medium | ✓ | ✓ | |
| Recording several studies | ✓ | ✓ | |
| Print | ✓ | ✓ | |
| Print images on paper | ✓ | ✓ | |

| Web DICOM Viewer features and tools | Lite | Pro | Web |
|----------------------------------------------------------------------------------------|-------------|------------|------------|
| Print images using a DICOM printer | ✓ | ✓ | |
| Arbitrary arrangement of images on the page | ✓ | ✓ | |
| Images arrangement templates | ✓ | ✓ | |
| Adding images to the header and the footer | ✓ | ✓ | |
| Changing several images simultaneously | ✓ | ✓ | |
| Adding reference images | ✓ | ✓ | |
| Exporting pages to the PACS server for printing | ✓ | ✓ | |
| Virtual endoscopy | | ✓ | |
| Manually navigate the inside a cavity | | ✓ | |
| Automatic synchronization with multiplanar reconstruction | | ✓ | |
| Centerline | | ✓ | |
| Fly-through camera | | ✓ | |
| Cavity scan | | ✓ | |
| Build cavity surfaces | | ✓ | |
| Video recording | | ✓ | |
| Perfusion parameters estimation | | ✓ | |
| CT and MRI studies support | | ✓ | |
| Results of perfusion parameters evaluation in the form of CBV, CBF, MTT, and Tmax maps | | ✓ | |
| Creation of report | | ✓ | ✓ |
| Edit and format text | | ✓ | ✓ |
| Create and edit tables | | ✓ | ✓ |
| Insert images from the clipboard | | ✓ | ✓ |
| Create report templates | | ✓ | ✓ |
| Autocompletion of tag values from study series | | ✓ | |
| Export a report in a PDF file | | ✓ | |
| Export a report in a DICOM DOC series | | ✓ | ✓ |
| View ECG | ✓ | ✓ | ✓ |
| View graphs | ✓ | ✓ | ✓ |
| Measure time intervals and values on graphs | ✓ | ✓ | ✓ |

| Web DICOM Viewer features and tools | Lite | Pro | Web |
|-----------------------------------------------|-------------|------------|------------|
| Using filters | | ✓ | ✓ |
| Export graphs to a new series of DICOM images | | ✓ | ✓ |

«Pro» and «Lite» are the Inobitec DICOM Viewer editions. This is another product. More information can be found in the [Products](#) and [Downloads](#) pages.

Getting Started

To avoid problems with the Web DICOM Viewer, do the following before you start working with the program:

1. Examine the browser you are using to work with the Web DICOM Viewer. Do not use keyboard shortcuts that can close the browser (for example Ctrl + W) or interfere with its operation.
2. Limit the access to the computers with the program installed in order to protect the patients' personal data and unauthorized deletion of information.
3. Do not give your login and password to the system and license keys to unauthorized persons. Store this data in a safe place.
4. If you need to download data from other software, check the connection settings by downloading test data.
5. Make sure that the data downloaded from the modality can be viewed in the modes chosen.
6. To avoid data loss in the event of a failure of the computer on which the storage is located, back up data regularly.

Before starting a procedure that requires the flawless operation of the Web DICOM Viewer, connect the PC to an uninterruptible power supply and check that it is working properly.

Chapter 1

Login to the Web DICOM Viewer

1.1 Login

To log in, type the following in the browser's address bar:
http://<ip address>:<port>

Obtain the IP address and port values from the administrator to log in.

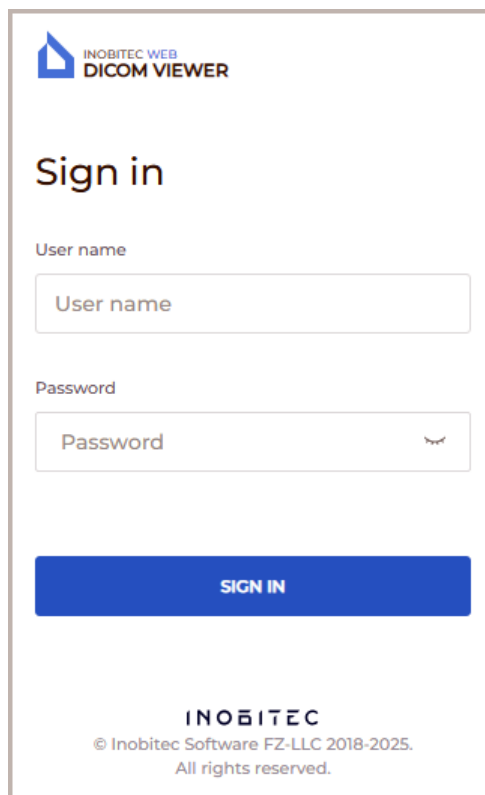

The image shows a web browser window displaying the login page for Inobitec Web DICOM Viewer. At the top left is the logo, which consists of a blue square with a white triangle pointing up and to the right, followed by the text "INOBITEC WEB DICOM VIEWER". Below the logo is the heading "Sign in". There are two input fields: "User name" and "Password". The "User name" field contains the placeholder text "User name". The "Password" field contains the placeholder text "Password" and a small eye icon on the right side. Below the input fields is a blue button with the text "SIGN IN" in white. At the bottom of the page, the text "INOBITEC" is displayed, followed by "© Inobitec Software FZ-LLC 2018-2025. All rights reserved."

Figure 1.1: Login Form

After opening the page, the login form will be displayed (Fig. 1.1). When a field is empty, its name is displayed in it. To type data in a field, place the cursor in it with a left-click. To move to the next field, press the **Tab** key on the keyboard or use the left mouse button to position the cursor. To go to the previous field, press the keys **Shift + Tab**.

Type the following data:

- type user name to the **User name** field;
- type password to the **Password** field.

You can get this information from the program administrator. All fields are required.

By default, the entered password is hidden and displayed as dots. To make the password visible in the input field, click on the icon representing a closed eye.

Click the **Sign in** button.

In case of an error, a message appears in the lower right corner.

To escape the program, click on the menu  button in the upper right corner of the window. Choose **Exit** in the button menu (Fig. 1.2).

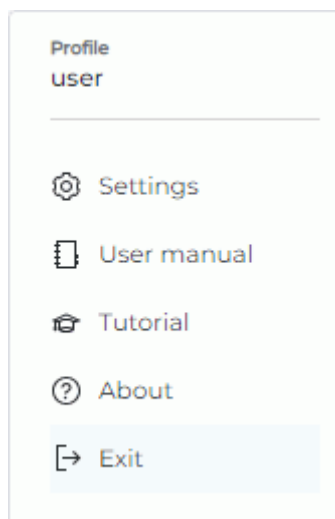

Figure 1.2: Escape the program

1.2 Tutorial and Usermanual

When the user first logs in, the window shown in Fig. 1.3 will be displayed.

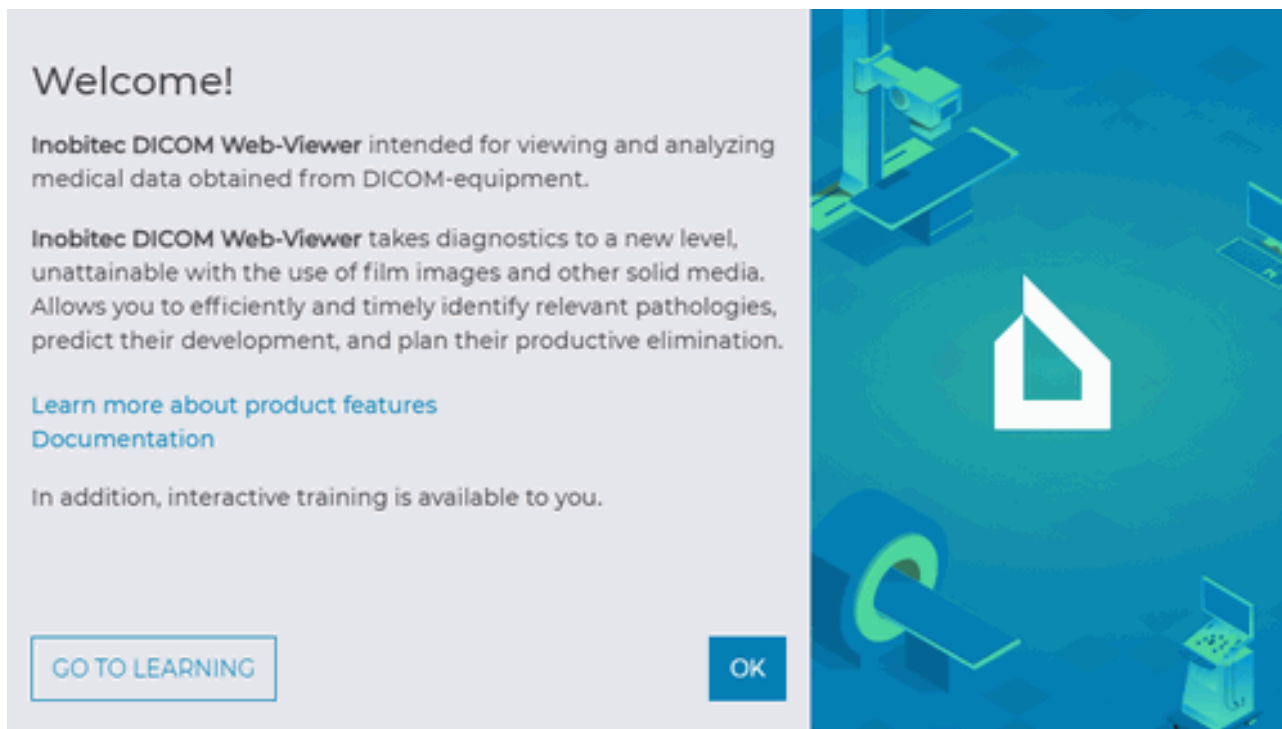





Figure 1.3: Welcome Window

To view the program features, click the **Learn more about product features** link, to open usermanual (pdf file) click the **Documentation** link. To view the tutorial click the **START TUTORIAL** button. To start learning, click on the menu  button and select the **Tutorial** item (Fig. 1.2).

1.3 Version of Web DICOM Viewer

To find out the Web DICOM Viewer version, click on the menu  button in the upper right corner of the window. Choose **About** item in the button menu (Fig. 1.2).

The Web DICOM Viewer version may be required to get technical support. There are several ways to find out the product version:

- on the main page, click the  button and select the **About** item from the button menu;
- on the study viewer page, left-click on the program logo.

A window will pop up with the following information about the program (Fig. 1.4):

- The Web DICOM Viewer version;
- Link to the website of the software developer;
- Sales email address;
- Email address of the Inobitec Software FZ-LLC Technical Support.



Figure 1.4: Product information

Chapter 2

The Web DICOM Viewer Settings

To change settings click the  button and select the **Settings** item. The window shown in the Fig. 2.2 will be opened.

2.1 User Settings Menu

The Web DICOM Viewer user settings menu is shown in Fig. 2.1.

To change the interface language, click the language selection button in the bottom left corner (marked with the number «1» in Fig. 2.1). To change the interface theme, click the toggle switch marked with the number «2» in Fig. 2.1.

To end the user session and exit the program, click the  button on the settings menu.

To return to the main page, click the  button.

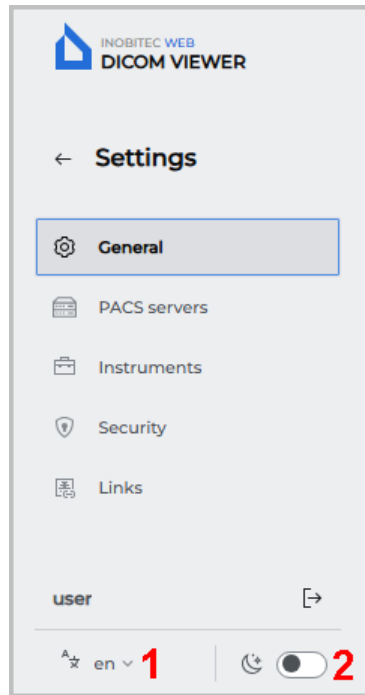

Figure 2.1: Web DICOM Viewer User Settings Menu

2.2 General settings

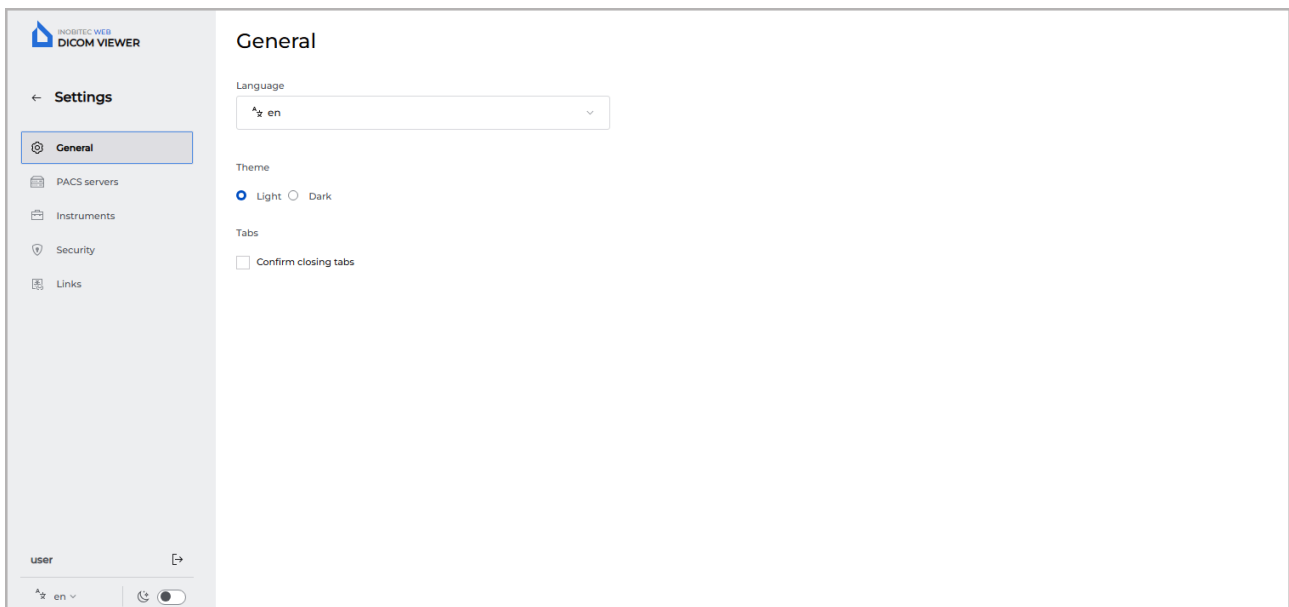

Figure 2.2: General settings

The following parameters are set up in this tab:

- interface language (English, Portuguese);
- interface theme (light and dark);
- confirmation dialog box that pops up when tabs are closed. This option is disabled by default.

2.3 Configuring the Connection to PACS Servers

On the **PACS servers** page, you can configure personal connections to PACS servers and applications with which data exchange via the DICOM protocol becomes possible. Personal connections to PACS servers are only available to the users of the Web DICOM Viewer who created these connections.

The table displays the parameters of PACS servers connected to the Web DICOM Viewer. Personal user connections are marked with a flag in the **Personal** column.

For more details on setting up the display of table parameters, see Section 2.7.1. Parameters can be sorted in the table by the values in one of the displayed columns (see Section 2.7.2).

The screenshot shows the 'PACS servers' configuration page. On the left is a sidebar with 'Settings' and 'PACS servers' selected. The main area contains a table of PACS servers and a settings panel on the right.

| # | ↑ | Name | Host | Port | Server m... | Client na... | Service n... | Charset | Personal |
|---|---|------------|-------------|------|-------------|--------------|--------------|------------|----------|
| 1 | | PACS_in... | 192.168.1.2 | 3000 | cget | | PACS_test | ISO_IR 192 | |
| 2 | | PACS_in... | 192.168.1.2 | 3000 | cget | USER-AE | PACS_test | ISO_IR 192 | ✓ |

The settings panel on the right is titled 'PACS server settings' and 'SCU list'. It contains the following fields:

- Name: PACS_Inobitec
- Host: 192.168.1.2
- Port: 3000
- Server mode: cget
- Client name (SCU): USER-AE
- Service name (SCP): PACS_test
- Charset: ISO_IR 192

Buttons for 'CANCEL' and 'SAVE' are at the bottom of the settings panel.

Figure 2.3: PACS servers

To add a new personal connection to a PACS server, follow these steps:

1. Click the **ADD PACS SERVER** button.
2. In the **Add PACS server** dialog box that pops up (Fig. 2.4), fill in the following fields:
 - in the **Name** field, enter the PACS server name;
 - in the **Host** field, type the PACS server IP address without spaces;
 - in the **Port** field, enter the port value in the range from 0 to 65535;
 - on the **Server mode** dropdown list, select the desired mode;

- in the **Client name (SCU)** field, type the name of the client connected to the PACS server. If a non-existent SCU is entered, a dialog box pops up where you have either to confirm the creation or elect not to create a new SCU;
 - in the **Service name (SCP)** field, type the name of the server on which the PACS server is installed;
 - on the **Charset** dropdown list, select the encoding supported by the PACS server.
3. Click the **SAVE** button to save the information and close the window, or **CANCEL** to cancel.

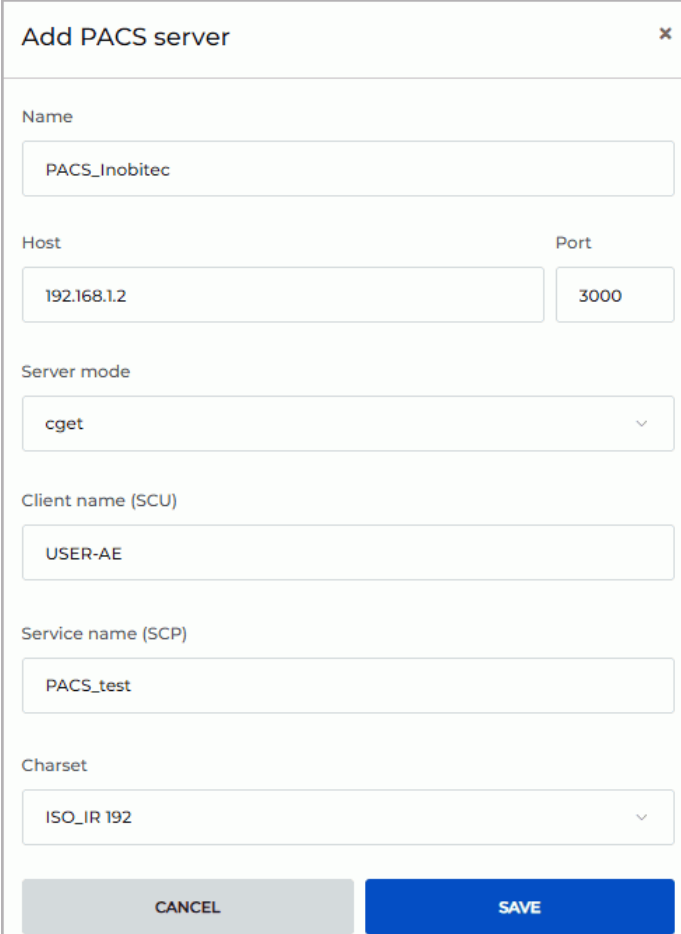

The image shows a dialog box titled "Add PACS server" with a close button (X) in the top right corner. The dialog contains the following fields and controls:

- Name:** Text input field containing "PACS_Inobitec".
- Host:** Text input field containing "192.168.1.2".
- Port:** Text input field containing "3000".
- Server mode:** Dropdown menu with "cget" selected.
- Client name (SCU):** Text input field containing "USER-AE".
- Service name (SCP):** Text input field containing "PACS_test".
- Charset:** Dropdown menu with "ISO_IR 192" selected.
- Buttons:** "CANCEL" (grey) and "SAVE" (blue) buttons at the bottom.

Figure 2.4: Create a new PACS server

To modify the connection parameters of any PACS server, perform the following:

1. Select the PACS server from the list and edit its parameters in the **PACS server settings** tab located on the right side of the page (Fig. 2.3).
2. Click the **SAVE** button to apply the changes, or **CANCEL** to cancel.

The user can edit personal connections to PACS servers that they have created. Editing shared connections to PACS servers is not available to the user.

Attention! After changing the PACS server name, the studies stored on that PACS server become unavailable for opening via previously created links.

The functions of creation, editing, and deletion of SCU clients are available on the SCU list tab, which is located on the right-hand side of the **PACS servers** page (Fig. 2.5).

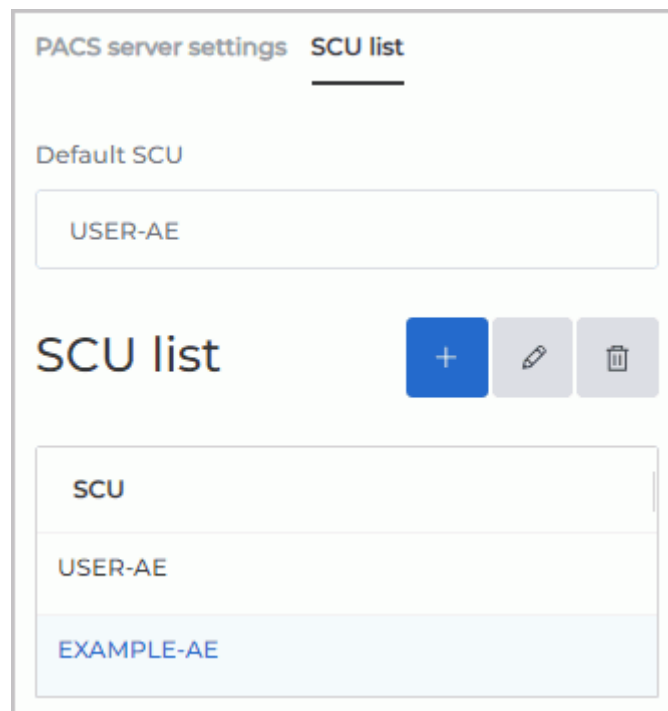



Figure 2.5: SCU list tab

At the top of the **SCU list** tab, there is a read-only **Default SCU** field. The SCU name in this field is set by the administrator and cannot be deleted or edited by the user. The **Default SCU** is used for shared connections to PACS servers.

At the bottom of the tab, there is a list of SCUs available to this user.

To add a new SCU, click the **Add SCU** button . In the dialog box that pops up, enter a unique name for the new client. Click the **YES** button to add a new client, or **CANCEL** to cancel. The new client is added to the SCU list.

Attention! The added client SCU must be unique for all the Web DICOM Viewer users. If the SCU already exists, a respective message will pop up.

To edit a client's name, select it on the list and click the **Edit SCU** button . In the dialog box that pops up, edit the current value. Click the **YES** button to save the changes, or **CANCEL** to cancel.

To delete an SCU, select it on the list and click the **Delete SCU** button . In the confirmation dialog, click **YES** to delete the SCU, or **CANCEL** to cancel.

To delete a connection to a selected PACS server, click the **Delete PACS server** button . In the confirmation dialog box, click **DELETE PACS SERVER** to delete or **CANCEL** to cancel.

2.4 Hotkeys

Attention! By default, hot keys are assigned by the administrator for all the users on the Hotkeys page of the admin panel.

The **Instruments** tab is used for customizing the tools availability on the toolbar or the context menu, as well as for assigning key combinations to certain tools or actions.

The table shows the settings for tools and the respective hot keys. For details on customizing parameters display options, see Section 2.7.1. The tools may be sorted in the table by the values shown in one of the columns (see Section 2.7.2).

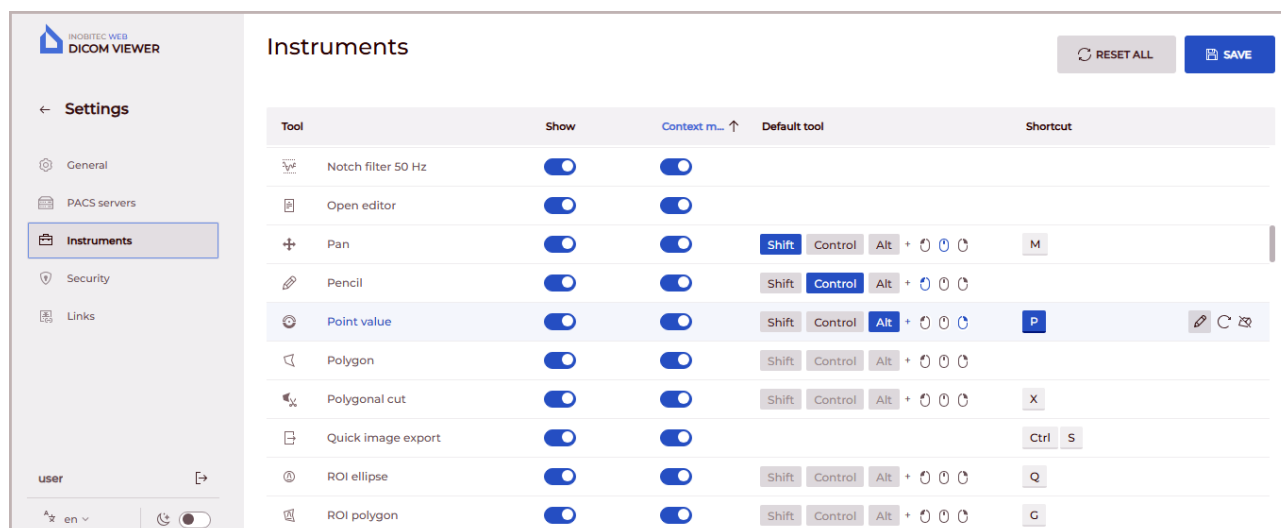

| Tool | Show | Context m... ↑ | Default tool | Shortcut |
|--------------------|-------------------------------------|-------------------------------------|------------------------------|----------|
| Notch filter 50 Hz | <input checked="" type="checkbox"/> | <input checked="" type="checkbox"/> | | |
| Open editor | <input checked="" type="checkbox"/> | <input checked="" type="checkbox"/> | | |
| Pan | <input checked="" type="checkbox"/> | <input checked="" type="checkbox"/> | Shift Control Alt + ⬅️ ⬇️ ⬆️ | M |
| Pencil | <input checked="" type="checkbox"/> | <input checked="" type="checkbox"/> | Shift Control Alt + ⬅️ ⬇️ ⬆️ | |
| Point value | <input checked="" type="checkbox"/> | <input checked="" type="checkbox"/> | Shift Control Alt + ⬅️ ⬇️ ⬆️ | P |
| Polygon | <input checked="" type="checkbox"/> | <input checked="" type="checkbox"/> | Shift Control Alt + ⬅️ ⬇️ ⬆️ | |
| Polygonal cut | <input checked="" type="checkbox"/> | <input checked="" type="checkbox"/> | Shift Control Alt + ⬅️ ⬇️ ⬆️ | X |
| Quick image export | <input checked="" type="checkbox"/> | <input checked="" type="checkbox"/> | | Ctrl S |
| ROI ellipse | <input checked="" type="checkbox"/> | <input checked="" type="checkbox"/> | Shift Control Alt + ⬅️ ⬇️ ⬆️ | Q |
| ROI polygon | <input checked="" type="checkbox"/> | <input checked="" type="checkbox"/> | Shift Control Alt + ⬅️ ⬇️ ⬆️ | G |

Figure 2.6: Hotkeys

If you want a tool or action to be displayed on the toolbar, put the switch in the **Show** column in the right position. If you want to hide the tool, choose the left position of the switch. If you want a tool to be shown on the context menu, put the switch in the **Context menu** column in the right position. If you don't want the tool to be shown, choose the left position of the switch.



In the **Default tool** column, a combination of modifier keys (**Shift**, **Ctrl**, **Alt**) and mouse buttons is assigned to activate the tool when the specified combination is pressed. To change or assign a default key combination to the selected tool, proceed as follows:

- click on one of the thumbnails with a mouse image to activate the selected tool with the left, middle, or right mouse button;
- select a modifier key.



The combination of a mouse button and a modifier key must be unique for each tool. If the selected mouse button and modifier key are already in use, they are displayed in red, and a warning about the duplication of an existing combination is shown. The **SAVE** button becomes inactive. Assigning a modifier key is not mandatory.

In the **Hotkey** column, you can see the hot keys assigned to the respective tools or actions. To change or assign a hot key for a selected tool or action, click the **Change hotkey**



button and enter the name of the key in the respective field. If the key is already being used for another action, a warning will pop up. To restore the administrator’s default key combination assigned to a tool or action, click the **Reset hotkey**  button. To delete a hot key assigned to a tool, click the **Remove hotkey**  button.

When the window size is small (≤ 1200 pixels), the **Default tool** and **Hotkey** columns are not displayed.

Click **SAVE**  to save the settings. To restore the default tool display settings and hot keys, click the **RESET ALL**  button. In the dialog box that appears, click **YES** to delete or **CANCEL** to cancel. The display settings for tools and the hotkey combinations are reset to the state provided for by the administrator.

2.5 Security

The **Security** tab is used to change the user’s password.

To change the password, type an old password to the **Old password** field, next type the new password to the **New password** and **Repeat new password** fields. When the password is entered, its strength is indicated. By default, the password you enter is hidden and displayed as asterisks. To display the password, click the icon in the shape of an eye.

To save the new user’s password, click on the **CHANGE PASSWORD** button.

2.6 Links Table

On the **Links** tab (Fig. 2.7), a list of links to studies created by users is displayed. The process of creating links is described in Chapter 8.

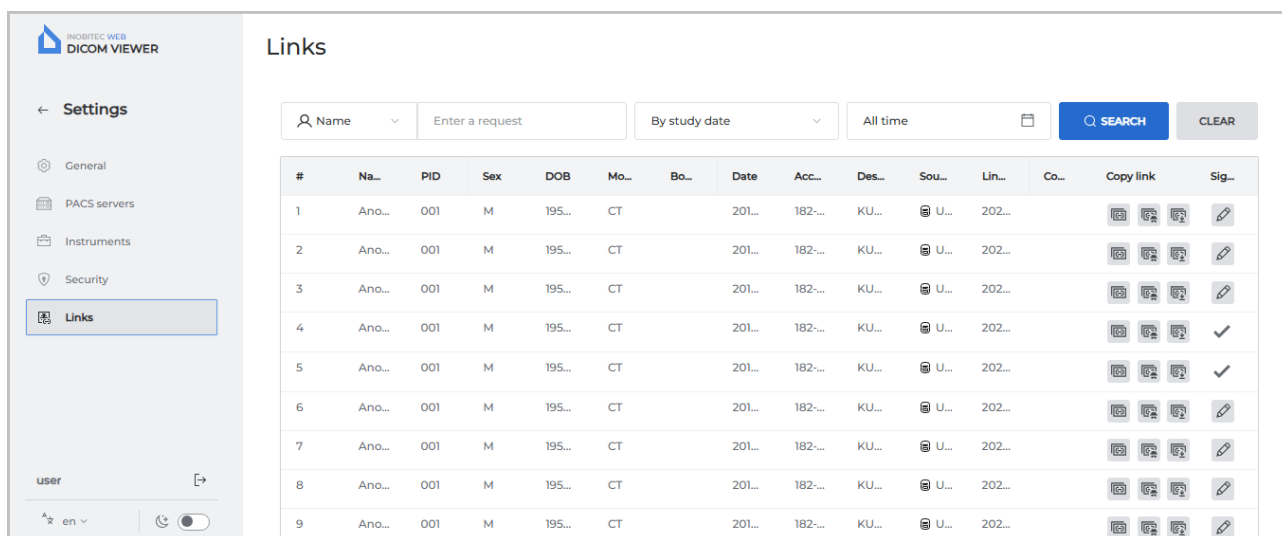

| # | Na... | PID | Sex | DOB | Mo... | Bo... | Date | Acc... | Des... | Sou... | Lin... | Co... | Copy link | Sig... |
|---|--------|-----|-----|--------|-------|-------|--------|--------|--------|--------|--------|-------|-----------|--------|
| 1 | Ano... | 001 | M | 195... | CT | | 201... | 182... | KU... | U... | 202... | | | |
| 2 | Ano... | 001 | M | 195... | CT | | 201... | 182... | KU... | U... | 202... | | | |
| 3 | Ano... | 001 | M | 195... | CT | | 201... | 182... | KU... | U... | 202... | | | |
| 4 | Ano... | 001 | M | 195... | CT | | 201... | 182... | KU... | U... | 202... | | | |
| 5 | Ano... | 001 | M | 195... | CT | | 201... | 182... | KU... | U... | 202... | | | |
| 6 | Ano... | 001 | M | 195... | CT | | 201... | 182... | KU... | U... | 202... | | | |
| 7 | Ano... | 001 | M | 195... | CT | | 201... | 182... | KU... | U... | 202... | | | |
| 8 | Ano... | 001 | M | 195... | CT | | 201... | 182... | KU... | U... | 202... | | | |
| 9 | Ano... | 001 | M | 195... | CT | | 201... | 182... | KU... | U... | 202... | | | |

Figure 2.7: Links

For each entry on the list, information is displayed about the study and the link created for it. Study parameters are shown in the following columns:

- #: link sequence number;
- **Name**;
- **PID** (Patient ID);
- **Sex**;
- **DOB** (date of birth);
- **Modality**;
- **Body part**;
- **Date** of the study;
- **Accession number**;
- **Description** of the study.

Information on the link is displayed in the following columns:

- **Source** (storage) where the study is located. If the study is hosted on a PACS server, the PACS server name is displayed in the cell;
- **Link creation date**;
- **Comment** on the link.

The user can perform the following actions:

- **Copy link** to the clipboard;
- **Sign link**. If a license for signing links is not available, the **Sign link** column is not displayed in the table, and the function of signing links is unavailable.

To copy a link to a study, click the **Copy link to open the study** button  in the selected line. The link is copied to the user's device clipboard.

To hide personal data when viewing a study via a link, click the **Copy link to open the anonymized study** button . The link is copied to the user's device clipboard. When the study is opened via this link, personal data is not displayed. You cannot view structured reports, logs, tags, and PDF documents for anonymized studies.

To copy a link that allows the user to open and download a study, click the **Copy link to open and download the study** button . The link is copied to the user's device clipboard. When the study is opened via this link, the user can download it (see Section 3.4.2).

If a link was not signed when created (see Sections 8.1 and 8.2), it can be signed on the **Links** page. To do this, click the **Sign link** button  in the respective line.

The server address (URL) provided in the link is the value of the `serverUrl` parameter in the `.config.json` configuration file and can be modified by the administrator. For detailed information, see the **Links Table** section of the Admin’s Manual.

Searching for study links is performed on the search panel, similar to searching for studies, and is described in Section 3.3. In addition, search by the link creation date is available.

At the bottom of the **Links** page, the number of links on the current page is displayed. To go to the next page of the list, click the **>** button; to go to the previous page, click the **<** button.

From the **items per page** dropdown list, select the number of links to be displayed per page. The default value is 20 links per page.

2.7 Tables

On the study Panel and on the **PACS servers**, **Instruments** and **Links** pages the data are presented in tables. The user can customize the tables for better presentation of information. Tables are customized and applied individually for each server user.

2.7.1 Customizing Parameters Display Options

To customize the parameters display options, right-click on the table header or any row in the table and choose the **Table settings** option in the right-click menu. A dialog box shown in Fig. 2.8 will pop up. Our example shows the settings for the table on the **Instruments** page. The table on the study panel can be customized by analogy.

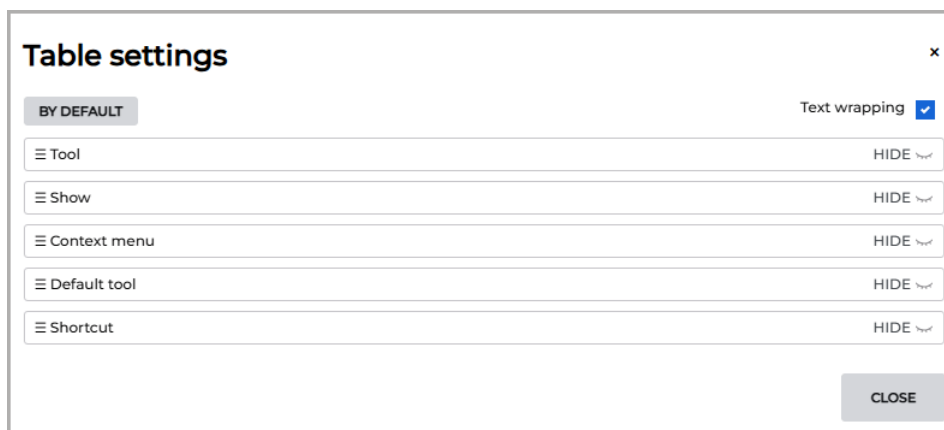



Figure 2.8: «Table settings» dialog box

To change the order of parameters display in the table header, move the cell with the selected parameter. To display or hide a column with a table parameter, click the **HIDE** or **SHOW** button in the cell with this parameter. Check the **Text wrapping** box to move the long value of parameters within the line. To restore the default settings, click the **BY DEFAULT** button.

To escape from the table settings dialog box, click the **CLOSE** button.

2.7.2 Sorting by Values

If there are several lines in the table, you can sort the lines by the values displayed in one of the columns. To do that, click on the header of a column with the respective parameter. Next to the name of this column, you will see an arrowhead showing the sorting order ( **down** — in descending order,  **up** — in ascending order). To change the sorting order, click on the column header once again. You cannot sort the lines by several parameters simultaneously.

2.7.3 Table Context Menu

To open the context menu for the table, right-click on a table row. The following commands are available on the context menu:

- **Copy value.** The value from the selected cell is copied to the clipboard;
- **Copy row.** All the *JSON* or *CSV* values are copied from the selected row to the clipboard;
- **Cancel selection** Deselects the row and the current item;
- **Table settings.** For details of the table settings, see Section [2.7.1](#).

Chapter 3

Program Window Elements

3.1 Toolbar

The **Toolbar** is shown in Fig. 3.1 (highlighted in red).

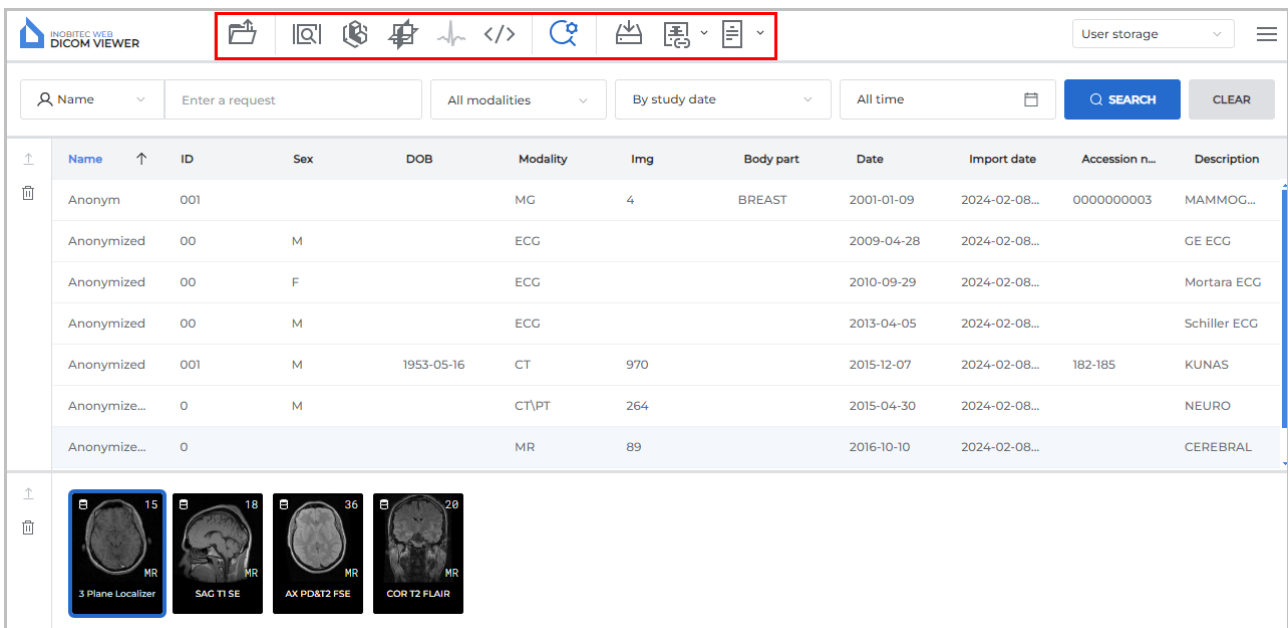













Figure 3.1: Toolbar location in the Web DICOM Viewer window

Buttons on the toolbar:

| | |
|-------------------------------------------------------------------------------------|---------------------------------------------------------------------------------------------|
|  | The Download study button loads data to the storage. |
|  | The Image viewer button opens images in the flat image view window. |
|  | The Volume reconstruction button opens images in the volume reconstruction window. |
|  | The MPR reconstruction button opens images in the multiplanar reconstruction window. |
|  | The ECG viewer button opens images in the ECG view window. |
|  | The Open tags button opens a window for viewing the tags of the series. |
|  | The Filter opens the search filter. |
|  | The Archiving button downloads studies as archives. |
|  | The Create link button creates a link to the selected study (see Chapter 8). |
|  | The Open editor button opens the report text editor (see Chapter 9). |

When the window size is small (≤ 900 pixels), some tools are hidden and become available only after clicking the  button (Fig. 3.2).

The dropdown list closes when an active tool is selected or when the user clicks beyond the area with the list (including the  button).

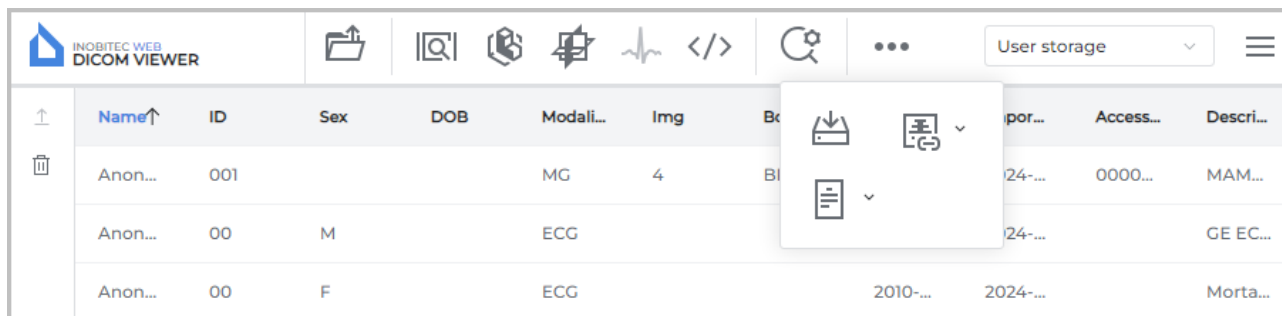

Figure 3.2: Dropdown list with hidden tools

If the action corresponding to a button is not available, the button looks pale and cannot be clicked (inactive). In Fig. 3.2 the **ECG viewer** button is inactive.

3.2 Select Data Source

To open studies stored on a PACS server or in a local folder, select the source from the drop-down list (Fig. 3.3).

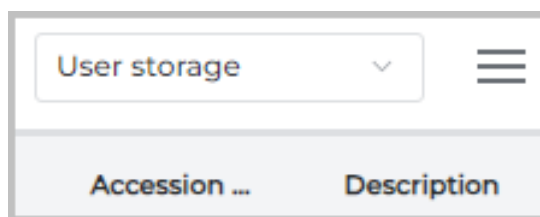

Figure 3.3: Data source panel

3.3 Search panel

To open or close the search panel, click the **Filter**  button on the toolbar. By default, the search bar is open. The search panel is shown in Fig. 3.4.



Figure 3.4: Search panel

One of the following search criteria should be selected from the dropdown list (number 1 in Fig. 3.4):

- name;

- **patient ID** (similar to search by name);
- **body part** (Enter the name of a body part in the text field. Under the text field, you will see some options that may be used for searching by body parts);
- **accession number** (similar to search by name);
- **description.**

Partial and full match search can be performed, as well as search with «*» and «?» wild-card characters. Below, you can see several examples of using these characters in various substitution scenarios.

The «?» character is used to substitute a single character. For example, «Sm?th» is used to search for Smeth, Smith, Smyth, etc.; «Smy??» is used to search for Smyth, Smy12, Smytt, etc.

The «*» character is used to substitute any number of characters. For example, «Joh*» finds John, Johnn, Johnsonn, etc.

Enter a search query in the **Enter a request** field (number 2 in Fig. 3.4). The maximum size of the text in the **Enter a request** field is 180 characters. Special symbols and national scripts may be used. The field may be empty.

To search for studies by modality, select the relevant modalities on the **All modalities** drop-down list (number 3 in Fig. 3.4). All the modalities are selected by default (the **Select all** button is active, see Fig. 3.5 «a»). The user may select any combination of modalities (see Fig. 3.5 «b»). To cancel the chosen modality, click the button once again.

Click **OK** to confirm or **CANCEL** to cancel.



Figure 3.5: Search by modality

The search panel also provides for search by date of birth, search by the date of study performance or study import. Select one of the following options from the drop-down list (see number 4 in Fig. 3.4):

- **by study date** (by default);

- **by import date;**
- **by date of birth.**

The following options will be available on the drop-down list (number 5 in Fig. 3.4) for selecting the search period:

- **all time** (by default);
- **today;**
- **yesterday;**
- **last week;**
- **last month;**
- **last year;**
- **exact date.** Select the exact date on the calendar or fill in the field in YYYY-MM-DD format;
- **interval.** Select the start and end dates of the interval in the calendar or fill in the field in YYYY-MM-DD — YYYY-MM-DD format.

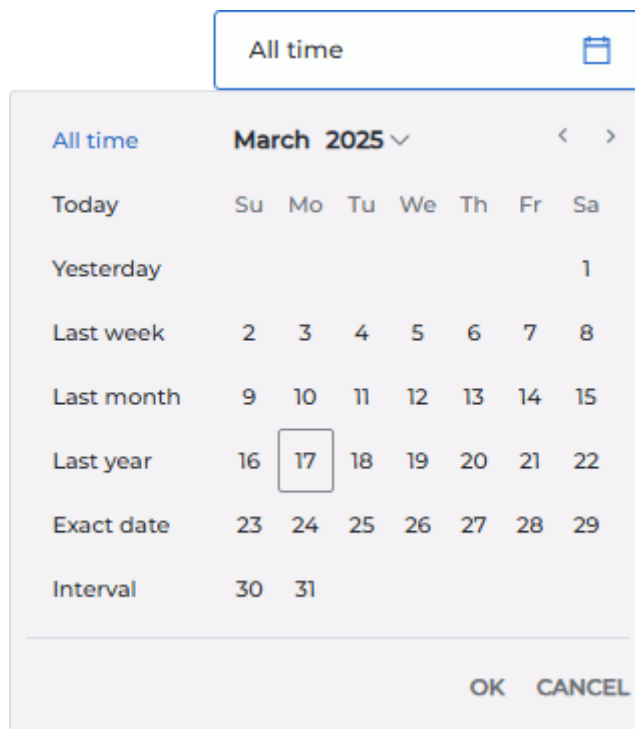

Figure 3.6: Available search periods

Click **OK** to enter the date or **CANCEL** to cancel. If the **Exact date** and **Interval** periods are not filled in completely, the **OK** button is not available.

After the relevant fields have been filled, click the **SEARCH** button. To reset the search criteria, click **CLEAR**.

The procedure of search performed on a PACS server without any specified filter parameters may take a long time and increase the server load. Therefore, when the user clicks the **SEARCH** button, the following message is displayed: **Search without parameters. It may take some time. Would you like to continue?** To proceed with the search, click the **YES** button; to cancel, click **CANCEL**.

The warning is not displayed when search is performed on a PACS server in the following cases:

- the search is performed by such parameters, as **Name, Patient ID, Accession number**, or **Description**, and the search query contains at least four characters;
- the search is performed **by study date**.

3.3.1 Setting Dates in the Calendar

The **Exact date** and **Interval** can be entered manually (from the keyboard) or by using the calendar in the search panel. To enter a date, left-click in the search period field (number 5 in Fig. 3.4) in the search panel. Select the **Exact date** or **Interval**.

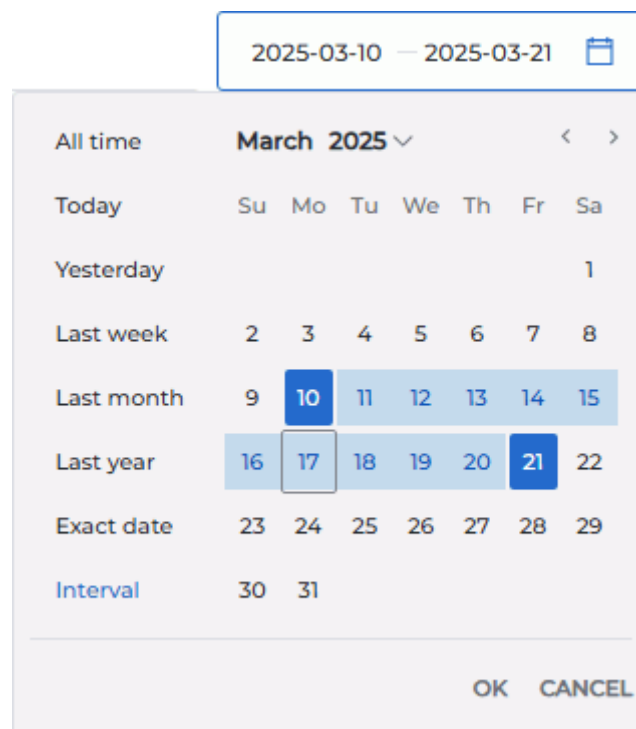

Figure 3.7: The time interval selected for the search

Use one of the following methods to specify the date:

1. **Manually.** Enter the exact date from the keyboard into the input field in the YYYY-MM-DD format, or enter the start and the end dates for the relevant period in the YYYY-MM-DD — YYYY-MM-DD format.

2. **Using the calendar.** To change the month, left-click on the name of the month. On the dropdown list, select the desired month. Similarly, set the required year and then select the day of the month from the calendar grid. The start and the end dates for the relevant period are set in the same way.

Click **OK** to enter the date or **CANCEL** to cancel. If the **Exact date** and **Interval** periods are not filled in completely, the **OK** button is not available. To reset the search criteria, click **CLEAR**.

3.4 Study Panel

The study panel is shown in Fig. 3.8 (highlighted in red).

| Name | ID | Sex | DOB | Modality | Img | Body part | Date | Import date | Accession n... | Description |
|--------------|-----|-----|------------|----------|-----|-----------|------------|---------------|----------------|---------------|
| Anonym | 001 | | | MG | 4 | BREAST | 2001-01-09 | 2024-02-08... | 0000000003 | MAMMOG... |
| Anonymized | 00 | M | | ECCG | | | 2009-04-28 | 2024-02-08... | | GE ECCG |
| Anonymized | 00 | F | | ECCG | | | 2010-09-29 | 2024-02-08... | | Mortara ECCG |
| Anonymized | 00 | M | | ECCG | | | 2013-04-05 | 2024-02-08... | | Schiller ECCG |
| Anonymized | 001 | M | 1953-05-16 | CT | 970 | | 2015-12-07 | 2024-02-08... | 182-185 | KUNAS |
| Anonymize... | 0 | M | | CT\PT | 264 | | 2015-04-30 | 2024-02-08... | | NEURO |
| Anonymize... | 0 | | | MR | 89 | | 2016-10-10 | 2024-02-08... | | CEREBRAL |

Figure 3.8: Study panel in the Web DICOM Viewer window

The study panel displays the list of studies stored in the selected location (user storage or PACS server).

For details on customizing parameters display the list of studies, see Section 2.7.1. The studies may be sorted in the table by the values shown in one of the columns (see Section 2.7.2).

To upload selected study to the remote PACS server, click on the **Upload to PACS server**  button on the left of the study panel.

To delete selected study from the storage, click on the **Delete study**  button on the left of the study panel. In the dialog box that appears, click **YES** to delete or **CANCEL** to cancel.

If the PACS server is selected as the data source, the studies panel will display a list of the studies stored on the PACS server. To download a selected study from the remote PACS

server, click the **Download from PACS server**  button on the left of the studies panel. The selected study is saved to the user's storage.

3.4.1 Uploading Studies

There are two ways to upload DICOM files to the user storage of the Web DICOM Viewer:

1. Click the **Download study**  button on the toolbar. In the dialog box that pops up, choose a folder with DICOM studies and click the **Load** button. Click the **Cancel** button to cancel.
2. Drag a folder with DICOM studies to the Web DICOM Viewer study panel. When a folder is being dragged, the study panel is replaced by a receive window. Release the mouse button when the cursor is inside the area marked with a dotted line to drop the file or folder.

When uploading studies, you will see a progress bar in the right-hand bottom corner. To interrupt the uploading process, click  in the right-hand top corner of the progress bar.

If the current DICOM upload process is not completed, no new DICOM files are uploaded by drag-and-drop. In this case, a message is displayed: **Wait for the download to finish**. Try again after the download is complete.

The list of uploaded studies is displayed on the Web DICOM Viewer study panel.

A study becomes available after the upload process begins. The study series displayed on the series panel can be opened during the study upload process.

3.4.2 Downloading Studies

The Web DICOM Viewer allows for downloading studies as archives from user storage or from a PACS server. The selected study is saved as an archive and may be opened by another viewer program, such as the professional edition of Inobitec DICOM Viewer.

A study can be downloaded by the user from the main page of Web DICOM Viewer, from the list of studies, as well as from the study viewing page.

To download a study from the study list, proceed as follows:

1. On the study panel, select from the list the study you want to download.
2. Click the **Archiving**  button on the toolbar. The process of archiving and downloading a study cannot be canceled.

To download a study from the viewer page, follow these steps:

1. In the open viewer tab on the series panel, select the study you need to download. To do this, hover the cursor over the list of studies opened in the current tab. When you hover over the study title, its frame is highlighted, and the archiving  button is shown in the header (Fig. 3.9).

2. Click the archiving button  in the header of the selected study. The process of archiving and downloading the study cannot be canceled.

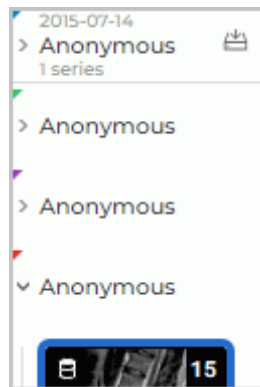

Figure 3.9: Selecting a study on the series panel for downloading

The name of the archive with the study is displayed in the *<Patient name>-<Study date>.zip* format.

Depending on the browser settings,

- The archive with the study may be saved in the **Downloads** folder, or
- A standard file saving dialog box may pop up.



3.5 Series Panel

The panel is shown in Fig. 3.10 (highlighted in red). Select the study from the study panel to see the list of series for it.

| Name | ID | Sex | DOB | Modality | Img | Body part | Date | Import date | Accession n... | Description |
|--------------|---------------|-----|------------|----------|-----|-----------|------------|-----------------|----------------|----------------|
| Anonymized | 001 | M | 1953-05-16 | CT | 970 | | 2015-12-07 | 2024-11-26 1... | 182-185 | KUNAS |
| Anonymize... | 0 | M | | CT\PT | 264 | | 2015-04-30 | 2025-03-17 ... | | NEURO |
| Anonymous | d14a028c2a... | M | 1995-10-25 | XA | 96 | | | 2025-03-17 ... | | |
| Anonymous | d14a028c2a... | F | 1923-10-16 | US | 11 | | | 2025-03-17 ... | | Echocardio... |
| Anonymous | d14a028c2a... | F | 1958-07-19 | XA | 17 | | | 2025-03-17 ... | | 8 images of... |
| Anonymous | d14a028c2a... | | | MG | 1 | BREAST | | 2025-03-17 ... | | MAMMOGR... |
| Anonymous | Anonymous | O | | MR | 90 | SPINE | 2019-10-07 | 2024-11-26 1... | | L-SPINE |

Figure 3.10: Series panel in the Web DICOM Viewer window

The following information is displayed in the thumbnail of each series:

- **modality;**
- **number of files in the series;**
- **series location indicator:** on the remote PACS server  or in the user's storage  ;
- **description.** If the series description is too long, the full description is shown in a pop-up tip when the user hovers over the thumbnail;
- **series status.** The selected series thumbnails are placed within a wide blue frame, while the thumbnails of the series opened for viewing are placed within a grey frame. A thin gray frame appears when the user hovers over a thumbnail.



If for some reason a series was not fully downloaded, in the upper right corner of the thumbnail, indicators are displayed showing the number of files in the series and their location: on the remote PACS server , downloaded , and saved in the user's storage .





Figure 3.11: Indicators on series thumbnails

To select several series, proceed as follows:

- To select several consecutive series, click on the first and the last thumbnails with the left mouse button while holding down the **Shift** key on the keyboard;
- To select several series located arbitrarily, click on the thumbnails of the selected series with the left mouse button while holding down the **Ctrl** key on the keyboard.

To deselect all the series thumbnails, click the left mouse button on the empty field within the window.

To upload selected series to the remote PACS server, click on the **Upload to PACS server**  button on the left of the series panel.



To delete selected series from the storage, click on the **Delete series**  button on the left of the series panel. In the dialog box that appears, click **YES** to delete or **CANCEL** to cancel.

If the PACS server is selected as the data source, the studies panel will display a list of the studies stored on the PACS server. To download the selected series from the remote PACS server, click the **Download from PACS server**  button on the left of the series panel. The selected series is saved to the user's storage.

3.6 View Images

The Web DICOM Viewer allows you to open a series of one or different studies in all available viewing modes in one tab.

You can open series in the desired mode in 4 ways:

- Click one of the **Image viewer** , **Volume reconstruction** , **MPR reconstruction** , **ECG viewer** , **Open tags**  on the left toolbar.

- Double-click on the thumbnails of the series on the series panel. The series will be opened in the **Image viewer** or **ECG viewer** window depending on the modality. If the series cannot be displayed, the DICOM tag viewer window will be opened.
- Right-click on the study and select one of the **Open in new tab** (the series will be opened in a new tab) or **Open in tab -> desired tab**. In this case, the first series of the study will be opened in a new window of the tab selected. The series thumbnails will be added to the series panel of the tab.
- Right-click on the series and select one of the proposed opening options (the series will be opened in a new tab) or **Open in tab -> desired tab**. In this case, the selected series of the study will be opened in a new window of the tab selected. The series thumbnails will be added to the series panel of the tab.

If the PACS server is selected as the data source, then in order to view videos or reports, you must download the selected series or the study containing the selected series to the user's storage.

The series panel will be displayed on the left. It displays studies and thumbnails of the series of the studies opened in this tab. The studies added are highlighted for some time when you go to the tab. The buttons with the functions available, the information on the study date, and the number of series in the study are showed when the user hovers the cursor.

To expand a study and display the series thumbnails, left-click on the study on the series panel. Go to the series thumbnails for another study by left-clicking on the header of the selected study.

To download a study as an archive, hover the mouse over the selected study and click the archiving  button in the study header (see Section 3.4.2).

To delete a study from the series panel, hover the mouse over the selected study and click the  button in the study header. When you delete a study, its series are deleted from the series panel. The windows with the open series from this study are closed. You cannot delete the first study to be opened. Close the tab with this study to escape.

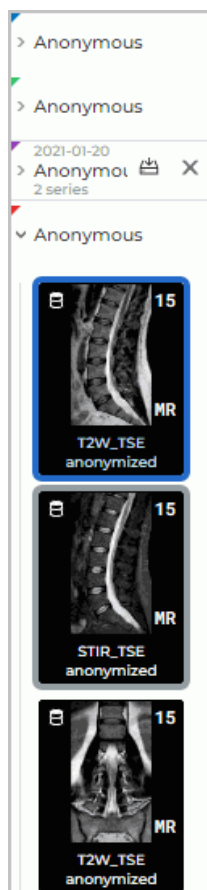

Figure 3.12: Series panel

3.7 View Multiple Series

There are several modes for positioning series windows in the study window. The selected mode is saved when the Web DICOM Viewer is closed.

When you open a new tab, automatic mode is always selected.

If when opening a new series of free cells to accommodate the images is not enough, then the automatic arrangement mode is activated and the required number of cells is added. For example, if only one cell is free, then two more cells are added to open the series in the MPR mode.

To maximize the series view window and restore its size, proceed as follows:

- double-click with the left mouse button on the title of the series window;
- click on the button in the right-hand upper corner of the series window.

To close the series view window click the button at the top right of the window.

3.7.1 Auto Mode

This mode is active by default. If two or more series are open, they will be located in the window and scaled automatically, occupying the entire window. Three series are displayed in

Fig. 3.13.

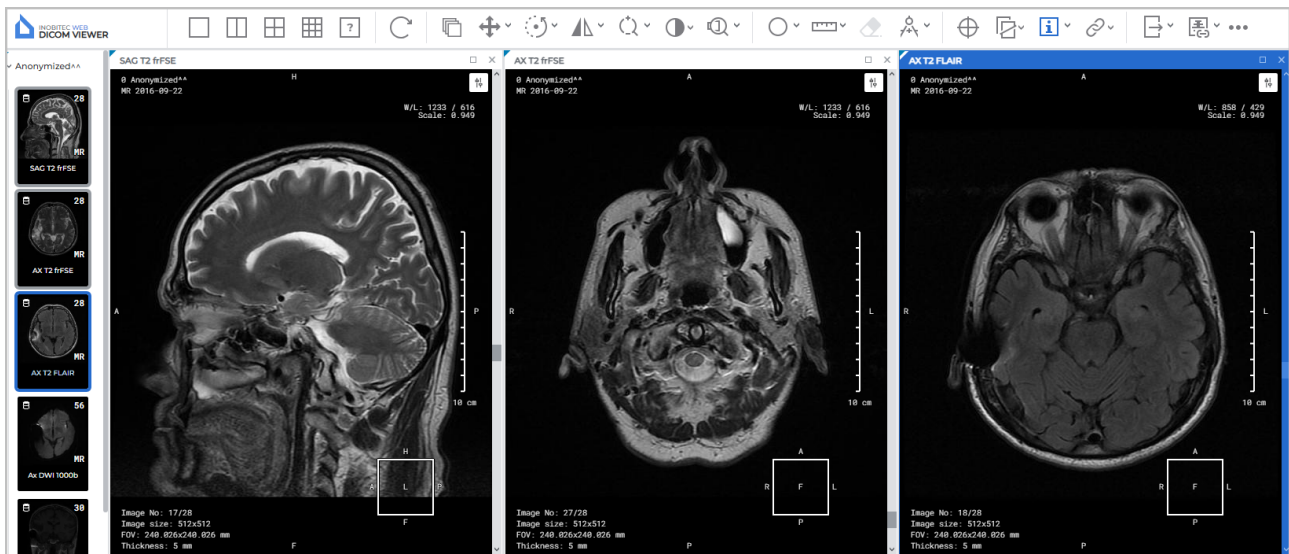

Figure 3.13: Auto Arrangement Mode

3.7.2 Stacked Mode

This tool allows you to receive only left-hand cell in the study window. In this case, the Web DICOM Viewer will request confirmation for closing the current series. If you try to open another series, the Auto Mode will be activated.

To activate this mode, click the button.

3.7.3 Grid Mode

In this mode the study window is split into parts, and a series window can be opened in each of them.

If all cells in the grid are filled, then auto mode will be activated.

A grid may have from 1 to 25 cells. The maximum number of rows and columns is 5.

Fig. 3.14 illustrates a 2*4 grid with three cells filled.

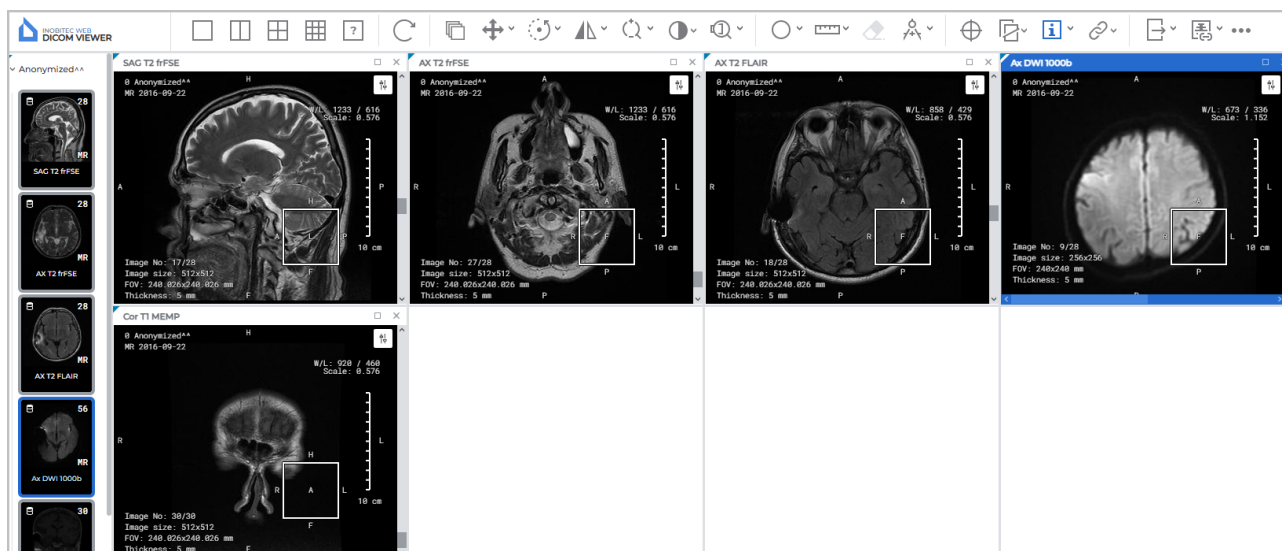



Figure 3.14: Displaying series in a 2*4 grid

To set up a 1x2, 2x2 or 3x3 grid, use the , ,  buttons on the toolbar.

To define your own grid configuration, click the  button. drag the cursor over the panel that opens and select the desired row and column counts (1 to 5). Click the left button in the desired cell to apply the configuration.

If the number of already open windows in the tab exceeds the number of cells in the selected configuration, a warning **Are you sure you want to do it? (The number of open series exceeds the number of cells you want to display)** appears.

To apply a configuration, click **YES**, to cancel, click **CANCEL**. If the number of cells is less than the number of open windows, then windows that do not fit will close. If at least one of the three MPR windows is not enough space, then all three windows for this series will be closed. If the tab has a sufficient number of unoccupied cells, then the newly opened series are reshared in them.

If a configuration from one cell is selected, this is equivalent to activation of the automatic mode.

3.8 Cancelling Tool Actions

At the top of the viewer window, icons of the tools that have been applied to the given series are displayed (Fig 3.15). To undo a transformation made with a tool, left-click on the icon representing this tool. To hide or show the icons of the tools applied to the series, left-

click on the  icon.



Figure 3.15: Tools applied to the series

To cancel all the changes made with different tools, click the **Restore original view**  button on the toolbar.

3.9 Tool Control Buttons

You can use the left, the right and the middle mouse button, which allows you to activate up to three tools at the same time. To activate a tool, click on the left-hand side of the button with the mouse button. There are two ways to deactivate a tool:

1. Activate another tool with the same button or
2. Click on the left-hand side of the tool button with the same mouse button.

On the tool button, you will see a symbol representing the mouse with the respective button selected (see Fig. 3.16).



Figure 3.16: The tools activated with the left, the middle and the right mouse button respectively (from left to right)

If a limited number of clicks is needed to create a graphic object (e.g. three clicks for corner measurements), then the creation process will be completed after these clicks. If you need an unlimited number of points to create a graphic object (e.g. a polygon or an MPR curve), you have to double-click the button with which the tool was activated to complete the creation process.

Objects made with a tool can be edited:

- with the left mouse button (always);
- with the right or middle mouse button, if a tool is assigned to them.

The right button click invokes the context menu.

3.10 Context menu

The context menu is available in the DICOM data view window (Fig. 3.17). The menu contains:

- tools available for the window in which it is open;
- setting the image sorting order (see Section 3.11);
- series that can be opened in the current window.

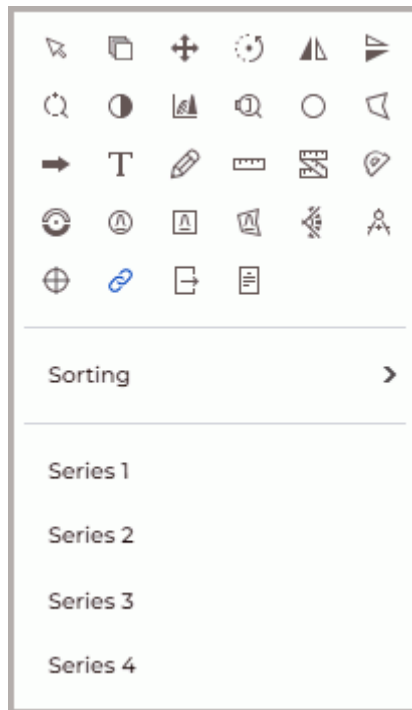

Figure 3.17: Context menu

The tools are activated with the left, right and middle mouse buttons (see Section 3.9).

3.11 Sorting images

By default, the images of a series are sorted by position. If necessary, change the sorting order of images. To do it, right-click on the image to open context menu, select the **Sorting** item, and then select one of the displaying modes:

- **No sorting;**
- **Sort by position** (set by default);
- **Sort by number.**

The current sorting parameter is highlighted on the context menu. For more details on the context menu, see Section 3.10.

For multiphase and multiframe series containing phases and/or frames, a horizontal scrollbar is displayed at the top of the window.

Chapter 4

View Flat Images



When viewing images, you may see some artifacts that can be attributed to the image compression method. If you see any artifacts, scale the image.



256 shades of gray or color are used to show the tissue density. As there are more than 256 density values, similar densities are represented by the same shade. To differentiate between similar values, decrease the window width. Hence, the 256 shades will be used to represent fewer density values.

4.1 View Images in a Series

When a series is opened, its first image is displayed in the series window.

There are three ways to switch to other images:

- Roll the mouse wheel up to switch to the previous image or down to go to the next one. One click of the wheel changes the position by one image.
- Use the scroll bar on the right-hand side of the series window. Move the slider along the bar to go to the image required.
- Use the **Scrolling** tool. Activate the tool by choosing the  button with the left, right, or middle mouse button. While holding this mouse button, move the cursor down to go to the next image or up — to go to the previous image. You will find the details concerning the use of the tools in Section 3.9.

4.2 Play images

The Web DICOM Viewer allows you to automatically play back images, frames or phases of a series at a certain speed. To set up playback, click on the right part of the **Play**  button on the toolbar and choose parameters (Fig. 4.1).

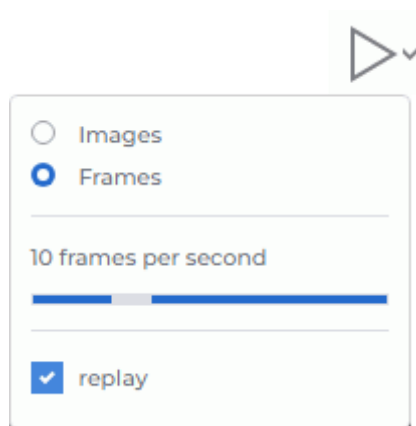





Figure 4.1: Playback setup menu

1. Select the playback mode (images or frames). The program automatically sets up the playback mode based on the following criteria:
 - if the series contains frames or phases, the program selects frames playback;
 - if the series contains only images (slices), the program selects individual images playback.
2. Select the speed (5, 10, 15, 20, or 25 frames per second).
3. If you want to play images cyclically, select the **Replay** item. The item will be marked with a flag. To disable the cyclic playback, select this command again. The flag will be removed.

To play the images click on the left side of the  button on the toolbar. During playback, the button looks like . To end playback, click the  button.

The **Play** tool is available in the **Image viewer**, **Volume reconstruction**, and **MPR reconstruction** windows.

4.3 Zoom. Move. Rotation



4.3.1 Zoom

To zoom an image, you can choose one of the following options:

1. Roll the mouse wheel while holding down the **Ctrl** key. To enlarge the image, roll the wheel forward; to shrink it, roll the wheel backward. The center of the zoomed image will be in the point where the cursor is placed.
2. Use the **Zoom**  tool on the toolbar. Click the arrow on the right-hand side of the **Zoom** button and choose one of the following options from the drop-down list:
 - fixed zoom level: x0.5, x1, x2, x3, or x4;

- **Custom zoom.** For this, you need to provide the zoom level from 0.1 to 10 in the dialog box. If the value entered is less than 1, the image will be shrunk. If the value is larger than 1, the image will be enlarged;
 - **Reset zoom** to fit the image to the screen.
3. Activate the **Zoom**, tool by clicking the left-hand side of the  button with the left, right, or middle mouse button. To work with this tool, use the button with which it was activated. You will find the details concerning the use of the tools in Section 3.9. To zoom the image, move the cursor up or down while holding the mouse button with which the tool was activated. In the window, you will see the point that is the center of the zoomed image. The current zoom level is displayed next to the cursor. When zooming has been completed, click the **Zoom**, button again to deactivate the tool.

To zoom images from the series of the same study simultaneously for all the open windows of the tab, follow these steps:

1. Click the arrow on the right-hand side of the **Series sync**  button on the toolbar.
2. From the dropdown menu of the  button, select the **Zoom and pan sync** option.

For details see Section 4.11.

4.3.2 Move

To pan an image, activate the **Pan** tool by clicking on the  button with the left, right, or middle mouse button. Use the same button to work with the tool. For details on working with tools, see Section 3.9. Drag the image with the mouse, holding the mouse button with which the tool was activated.

To restore the initial position of the image, click the arrow on the right-hand side of the **Pan** button and select **Position reset**. If you want to change the position of images in all the open windows of the tab, click the arrow on the right-hand side of the **Series sync**  button and select **Zoom and pan sync**.

4.3.3 Rotation



To rotate an image, you can choose one of the following options:

1. Use the **Rotation**  tool on the toolbar. Click the arrow on the right-hand side of the **Rotation** button and choose one of the following options from the drop-down list:
 - a fixed rotation angle (a multiple of 90°): 90° clockwise, 180°, or 90° counterclockwise;
 - **Custom rotation.** For this, you need to provide the rotation angle from -360° to 360° in the dialog box;

- **Reset rotation** to restore the initial position of the image. When rotation is reset, the scale and the position of the image are kept.

2. To rotate an image by an arbitrary angle, click the left-hand side of the **Rotation**  button with the left, right, or middle mouse button. To work with this tool, use the button with which it was activated. You will find the details concerning the use of the tools in Section 3.9. To rotate the image, move the mouse while holding the button with which the tool was activated. The image is rotated about the center of the window. While the image is being rotated, the current rotation angle is displayed. When rotation is completed, click the **Rotation** button again to deactivate the tool.

To rotate images from the series of the same study simultaneously for all the open windows of the tab, follow these steps:

1. Click the arrow on the right-hand side of the **Series sync**  button on the toolbar.
2. From the dropdown menu of the  button, select the **Rotation sync** option.

For details see Section 4.11.

4.4 Set Window Level and Width

The window width and level values can be changed in the **Image viewer**, **Volume reconstruction**, and **MPR reconstruction** windows.

4.4.1 Change W/L Tool

To change the parameters, activate the **Change W/L**  tool on the toolbar with the left/right/middle mouse button. To continue work with this tool, use the button with which the tool was activated. To learn more about tool control, see Section 3.9. Move the mouse in the study window, holding the right mouse button

- to increase the window level — down;
- to reduce the window level — up;
- to reduce the window width — left;
- to increase the window width — right.

The current window level and width values are displayed in the top right-hand corner of the window.

4.4.2 Selecting Preset Window Width and Level Values

The contains predefined width and level values for some specific tissues. To select them, click on the left side of the **Change W/L**  button. The following modes will be available in the newly opened window:

- **Abdomen** — for viewing abdominal tissues;
- **Bones** — for viewing bone tissues;
- **Brain** — for viewing brain tissues;
- **Lungs** — for viewing lung tissues;
- **Thorax** — for viewing chest tissues;
- **Headneck** — for viewing head and neck tissues.

To set the default window width and level values (automatically determined by the Web DICOM Viewer as optimal), select **Reset W/L**.

4.4.3 W/L Settings Dialog Box

The **W/L** dialog box is non-modal, which means it does not block the program interface and can remain open while the user continues working with the program. The dialog box is designed for quick adjustment of the window width and level. All the changes made in the box are immediately applied to the series window. The changes of the window width and level in the series window are immediately reflected in the **W/L** dialog box.

To open the **W/L** dialog box, click the arrow on the right-hand side of the **Change W/L**  button and select **Histogram** from the dropdown list.

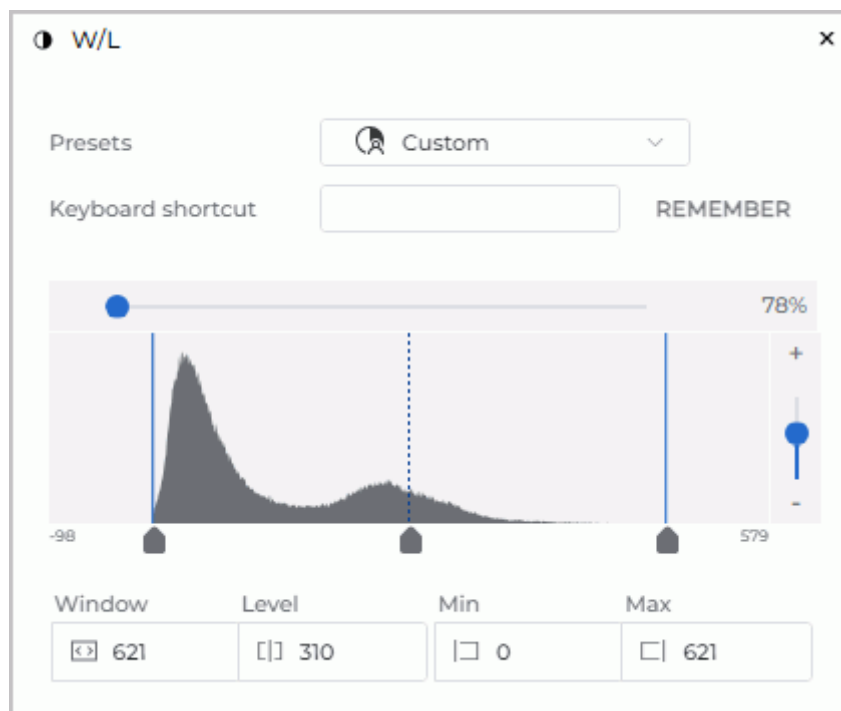

Figure 4.2: Dialog box **W/L** settings

In the opened **W/L** dialog box that pops up (Fig. 4.2), set the window width and level parameters using one of the following methods:

1. Select preset values from the **Presets** dropdown list. The **Presets** list contains standard preset values for viewing certain tissues. The list of presets is similar to the one described in Section 4.4.2). If required, change the keyboard shortcut for the selected preset (see Section 4.4.4).
2. Manually specify the values in the **Window**, **Level**, **Min** and **Max** fields of the **W/L** dialog box. When a value is changed in one of the fields, the values in the other fields are changed automatically according to the following formulas:

$$\mathbf{Window = Max - Min;}$$

$$\mathbf{Level = (Max + Min)/2.}$$

If the window width and level settings provided are different from the existing presets, a **Custom W/L** value will be shown on the **Presets** dropdown list.

3. Adjust the window width and level values using the histogram (see Section 4.4.5).

If the window width and level settings provided are different from the existing presets, a **Custom W/L** value will be shown on the **Presets** dropdown list.

4.4.4 Changing Hotkeys for Presets

To assign or change a preset hotkey, proceed as follows:

1. Open the **W/L** dialog box by clicking the arrow on the right-hand side of the **Change W/L**  button and selecting **Histogram** from the list.
2. Select the required preset from the **Presets** dropdown list.
3. Enter the desired key combination in the **Keyboard shortcut** field. The permissible values are:
 - any single key on the alphanumeric keyboard or a function key, such as **A** or **F5**;
 - combinations of modifier keys (**Alt**, **Ctrl**, **Shift**) and alphanumeric or function keys pressed simultaneously, e.g. **Ctrl+H**, **Shift+F5**, or **Alt+Ctrl+Shift+Q**.

If the value entered in the **Keyboard shortcut** field is already assigned to another action or tool, the  icon will be displayed. If you hover on the icon, a pop-up tip will appear with the name of the tool to which the entered key combination is assigned.
4. Click **REMEMBER** to save the hotkey or **CANCEL** to cancel.

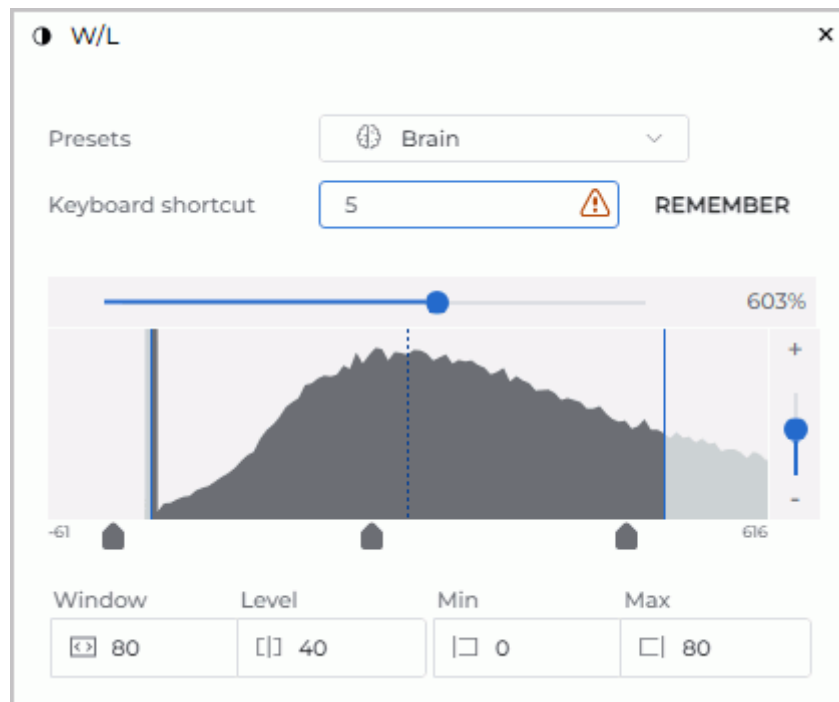



Figure 4.3: Changing the preset hotkey

Warning! If the entered key combination was previously assigned to another action or tool, by pressing the **REMEMBER** button, you will reassign the key combination to the selected preset.

4.4.5 Histogram

To adjust the window width and level values using the histogram, click the arrow on the right-hand side of the **Change W/L**  button and select **Histogram** from the dropdown list.

In the **W/L** dialog box, a histogram is displayed — a graph showing the relationship between the number of points and their intensity (Fig. 4.4). The horizontal axis of the graph represents intensity, while the vertical axis represents the number of points with that intensity. Below the graph, the intensity values at the start and the end points of the curve are shown.

In the **Image viewer** and **MPR reconstruction** windows, the histogram shows the values for the current image in the selected window. In the **Volume reconstruction** window, the histogram shows the values for the entire model.

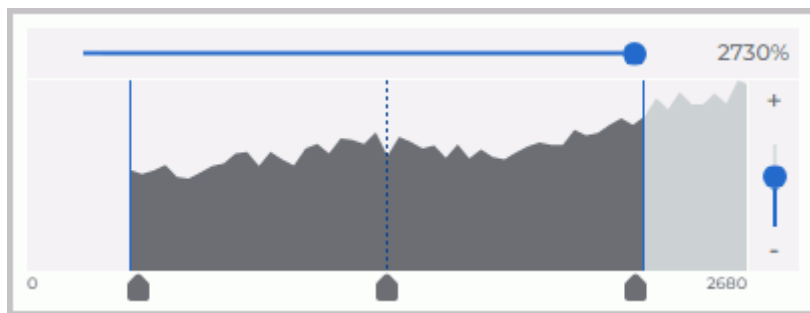

Figure 4.4: Image histogram

The current window width and level are marked with vertical blue lines. The center of the window is indicated by a vertical dashed blue line.

To move the level and width boundaries or the center line, hover the mouse over the slider placed below the boundary, and while holding the left mouse button, drag the boundary or the center line. The window level and width values will change simultaneously.

To move the histogram, hover the cursor over the graph and drag it while holding the left mouse button.

To rescale the graph along the horizontal axis, move the horizontal scrollbar placed above the graph. The scale value is displayed as a percentage on the right of the slider. To rescale the graph along the vertical axis, move the vertical slider placed on the right of the graph or press the + and – buttons above and below the slider.

4.4.6 Histogram for ROI

The histogram for ROI is a graph showing the distribution of point intensities within the ROI. The Web DICOM Viewer displays the intensity histogram for the ROI built.

Build an ROI on the image (see section 4.6.5).

To see the histogram for the ROI in the selected window, click the arrow on the right-hand side of the **Change W/L**  button and select **Histogram** from the dropdown list.

Each ROI has its own histogram on the graph. The color of the histogram matches the color of the tool which was used to build the ROI.

The intensity distribution graph for each ROI is stretched along the vertical axis until its peak reaches the maximum value (is normalized). As a result, each ROI histogram has its own scale. When the scale for the image histogram is changed, it does not affect the scale of the ROI histograms.

When the ROI on the image is edited, the histogram for the selected ROI is updated accordingly.

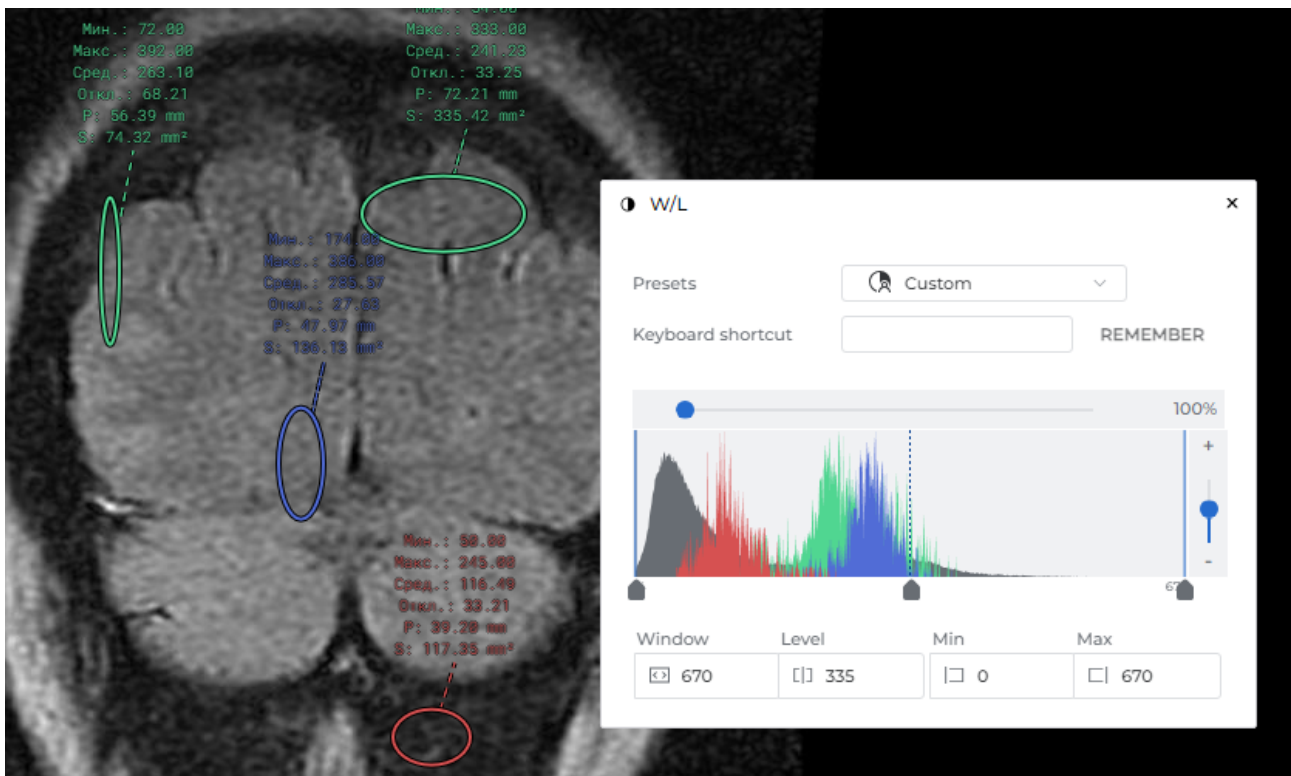



Figure 4.5: Histograms for ROI

4.5 Magnifier

This tool allows you to increase an area in the image with a zoom increment of 2 to 32 (Fig. 4.6).

To magnify an area in the image:

1. Activate the **Magnifier** tool by clicking the  button with the left, right, or middle mouse button. To work with this tool, use the button with which it was activated. You will find the details concerning the use of the tools in Section 3.9.
2. Move the cursor to the area you want to make out.
3. To increase the value of the zoom increment, click the mouse button with which the tool was activated. To reduce value, click the mouse button with which the tool was activated

holding down the **Alt** key on the keyboard.

- The default magnifier settings are configured in the **Tool options** dialog box. To open it, click the arrow on the right-hand side of the **Magnifier**  button and select the **Magnifier tool settings** command. Set the values:

- **radius** of the magnifier within the range from 20 to 1000 pixels;
- **magnification** within the range from 2 to 32.

To apply the default magnifier settings, click **YES**. To cancel the settings, click **CANCEL**.

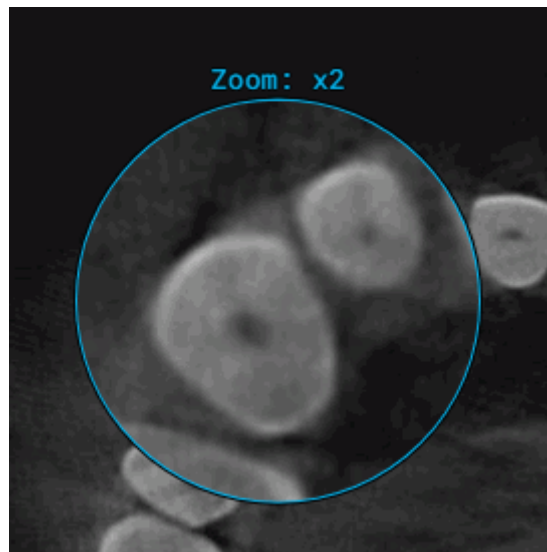

Figure 4.6: Tool Magnifier

4.6 Measurements











For projections (such as x-rays), you have to use the **Calibration tool** (see Section 4.9) to avoid the mistakes associated with the mismatch between the image size and the real size.



The measuring accuracy is one screen pixel. As screen pixels are smaller than the pixels of the original image, the actual linear measurement error will be equal to the size of the original image pixel. Certain inaccuracy is also associated with density measurements.

The following tools are used to measure various parameters: **Distance measurement ruler**, **Distance measurement polyline**, **Angle measurement**, **Point value**, **ROI ellipse**, **ROI rectangle**, **ROI polygon**, **Kobb angle**. To select one of these tools, click on the arrow on the right side of the tool selection button. From the drop-down list, select and activate the desired tool with the left, right or middle mouse button. To learn more about tool control, see



Section 3.9. The button will look different depending on the selected tool:

| | |
|-------------------------------------------------------------------------------------|--------------------------------------|
|  | Distance measurement ruler |
|  | Distance measurement polyline |
|  | Angle measurement |
|  | Point value |
|  | ROI ellipse |
|  | ROI rectangle |
|  | ROI polygon |
|  | Cobb Angle |

To activate or deactivate the tool that is currently selected, just click on the left side of the tool selection button with the left/right/middle mouse button. To continue work with this tool, use the button with which the tool was activated. To learn more about tool control, see Section 3.9. If some tool is activated, the button is highlighted. The drawn objects will be displayed in the window while it is open, and you can pan, zoom or rotate them together with the image.

4.6.1 Distance measurement ruler



To measure distance in an image:

1. Activate the **Distance measurement ruler**  tool on the toolbar. When the tool is activated, the cursor is displayed as  .
2. You can measure the distance in two ways:
 - Mark the first point by clicking the mouse button. Drag the cursor over the screen. The distance from the first point to the current point will be displayed beside the line. To fix the current point, click the mouse button.

- Click on the mouse button at the starting point and move the cursor to the endpoint while holding the mouse button. The distance from the first point to the current point will be displayed beside the line. To fix the endpoint, release the mouse button.
3. To cancel an incomplete measurement, press **Esc** on the keyboard.



4.6.2 Distance measurement polyline

To perform polygonal linear measurements:

1. Activate the **Distance measurement polyline**  tool on the toolbar. When the tool is activated, the cursor is displayed as  .
2. Mark the first point on the toolbar by clicking the mouse button.
3. Drag the cursor over the screen. The distance from the first point to the current point will be displayed beside the line.
4. To fix the current point, click the mouse button.
5. Repeat Steps 3 and 4 until the last but one point is fixed.
6. Fix the last point by double-clicking the mouse.
7. To cancel an incomplete measurement, press **Esc** on the keyboard.



4.6.3 Angle measurement

To measure an angle:

1. Activate the **Angle measurement**  tool on the toolbar. When the tool is activated, the cursor is displayed as  .
2. Put two points on the image, clicking the mouse button. The second point is the angle apex.
3. Move the cursor over the screen to set the other side of the angle.
4. Click the mouse button to fix the second side of the angle.
5. To cancel an incomplete measurement, press **Esc** on the keyboard.

4.6.4 Point ROI measurement







To measure intensity at some point:

1. Activate the **Point value**  on the toolbar. When the tool is activated, the cursor is displayed as  .
2. Click on the target point.

The point will be highlighted at the image, and the intensity value will be displayed next to it.

4.6.5 Measure the Intensity Average and Standard Deviation in an Area

To measure the average intensity value and standard deviation in a particular area:



1. Activate one of the **ROI** tools (rectangle  , ellipse  , or polygon ) on the toolbar. When the tool is activated, the cursor is displayed as  ,  or  .
2. To draw a rectangle, press the mouse button in its top left-hand and release on right-hand corners.
3. To draw an ellipse, just draw the rectangle the ellipse is inscribed in.
4. To draw a polygon, click the mouse button to mark each apex and then double-click the mouse to finish.
5. To cancel an incomplete measurement, press **Esc** on the keyboard.

The following parameters will be displayed next to the highlighted area:

- minimum intensity value;
- maximum intensity value;
- average intensity value;
- standard deviation;
- area perimeter;
- area space.

4.6.6 Cobb angle meter

To measure a Cobb angle:

1. Activate the **Cobb angle**  tool from the toolbar. When the tool is activated, the cursor is displayed as  .
2. Draw a line that runs along the border of one of the vertebrae. There are two ways to draw the line:
 - Mark the first point with the mouse click. Move the mouse cursor along the screen. To fix the current point, click the mouse button;
 - Press the mouse button at the starting point, then move the cursor to the endpoint while holding the mouse button down. To fix the current point, release the mouse button.
3. Likewise, construct a line for the second vertebra.
4. To cancel an incomplete measurement, press **Esc** on the keyboard.

4.6.7 Drawing Parameters

To set the default drawing parameters for measurement tools:

1. Click on the arrow on the right side of the measurement tool selection button.
2. Select the item **Measurement tool settings**.
3. In the dialog box that appears, set the color, line thickness and the font size.
4. Set length and area units (millimetres or centimetres).
5. To connect the footnote and the measurement of the dotted line, check the box **Footnote**.
6. To apply the settings, click **YES**. To cancel the settings, click **CANCEL**.

To edit the drawing parameters of an existing measurement:

1. Locate the cursor on the measurement to highlight a line or a point.
2. Right-click the mouse.
3. Select the **Tool options** item from the context menu.
4. In the dialog box that appears, set the parameters in the same way as the default drawing parameters. In addition, the user can assign a name to each measurement, and it will be displayed in the measurement results section.

4.6.8 Editing Measurements

In this Web DICOM Viewer, measurements can be edited:

- with the left mouse button (always);
- with the right or middle mouse button, if a tool is assigned to them.

To edit a measurement, follow these steps:

1. Hover the mouse over a line, point, or measurement result. When the mouse is placed on an object, the measurement is highlighted, and the cursor takes the shape of the respective tool.
2. Press the mouse button at the point where you want modifications to be made, and while holding the mouse button down, edit the measurement.
3. To complete the editing procedure, release the mouse button.

4.6.9 Move Measurements

To move a measurement:

1. Locate the cursor on the measurement to highlight the line or point or to magnify the cross, marking the angular point. Do not locate the cursor on angle points.
2. Move the measurement, holding the mouse button.

4.6.10 Moving the measurement data

The measurement data and other text information is provided next to lines, indices and highlighted areas. Sometimes the text is illegible; it may overlap the important parts of the image or other text.

In Web DICOM Viewer, you can move the texts placed next to graphics.

Mouse over the text you need to move. You will see a dotted frame round the text, and the text itself will be in bold. Hold down the mouse button and move it to another spot. For the user's convenience, the text is bound to the graphic element or to the respective image area with a dotted line.

When you move a measurement, the text area is also moved.

4.6.11 Delete Measurements

To delete measurement, locate the cursor on the measurement to highlight a line or a point and press the **Delete** key on the keyboard, or right-click the mouse and select the **Delete** item from the context menu.

To delete all annotations and measurements, click the **Delete all user overlay**  button on the toolbar. In the dialog box that appears, Click **YES** to delete or **CANCEL** to cancel. **Please note that all other graphic objects created manually will be deleted as well.**

4.7 Graphic Label Tools

4.7.1 General



This tool allows you to create graphic labels (as arrows, ellipses, polygons and text fields) on an image. The labels will be applied during the entire session of working with the series. The labels are attached to specific points on the image and panned, scaled or rotated together with the image.

The button design depends on the selected tool.



To activate/deactivate the selected tool, click on the left side of the graphic label tool selection button with the left/right/middle mouse button. To continue work with this tool, use the button with which the tool was activated. To learn more about tool control, see Section 3.9. To select and activate one of the tools, click on the right side of the tool selection button and select the tool.

4.7.2 Graphic Label Tool



To create a label on an image:

1. Activate the **Arrow**  tool. When the tool is activated, the cursor is displayed as  .
2. Draw an arrow using one of the two methods:
 - With a mouse click, mark the place where the arrow should be pointed. Move the mouse cursor along the screen. To fix the other end of the arrow, click the mouse;
 - By pressing the mouse button, mark the place where the arrow should be pointed. While holding the mouse button down, move the cursor along the screen. Release the mouse button at the point where the opposite end of the arrow should be placed.
3. To cancel an incomplete creation, press **Esc** on the keyboard.



To create a text label on an image:

1. Activate the **Text**  tool. When the tool is activated, the cursor is displayed as  .
2. Click the mouse button where the text should be located.
3. Enter text in the field that appears. To get to the next line, press the **Ctrl + Enter** key combination on the keyboard.
4. Press **Enter**, or **Esc**, or click the mouse outside the input field to complete the operation.



To create a freeform shapes and lines on an image:

1. Activate the **Pencil**  tool. When the tool is activated, the cursor is displayed as  .
2. Click the mouse button at the point where you want the line to begin and, while holding the mouse button, move the cursor. This displays a line that follows the cursor trajectory. To complete the drawing, release the mouse button.
3. To cancel an incomplete creation, press **Esc**.

To create a polygon on an image:

1. Activate the **Polygon**  tool. When the tool is activated, the cursor is displayed as  .
2. Click the mouse button where the first point of the polygon should be located.
3. Move the cursor to the location of the next point. The lines connecting the points of the polygon will be displayed on the screen.
4. Click the mouse button to save the point.
5. Repeat Steps 3 and 4 until the last but one point is set.
6. Double-click the mouse to create the last point. The polygon is complete.
7. To cancel an incomplete creation, press **Esc** on the keyboard.

To create an ellipse on an image:

1. Activate the **Ellipse**  tool. When the tool is activated, the cursor is displayed as  .
2. To build an ellipse, just build the rectangle the ellipse is inscribed into. Click the mouse button where the first angle of the rectangle should be located and hold it down.
3. Move the cursor to the location of the opposite angle. The ellipse will be displayed on the screen.
4. Release the mouse button to fix the opposite angle. The ellipse is complete.
5. To cancel an incomplete creation, press **Esc** on the keyboard.

4.7.3 Editing Annotations

In the Web DICOM Viewer, graphic annotations can be edited with the left mouse button, whichever tool is assigned to the left mouse button. Editing graphic annotations is similar to editing measurements (see Section 4.6.8).

4.7.4 Actions with Labels

The Web DICOM Viewer allows you to perform the following actions with labels:



- Drag. Locate the cursor on the figure line or text and drag the object, holding the left mouse button.
- Drag a point (an apex for an arrow or polygon and a rectangle apex for an ellipse). Locate the cursor on a point and drag the point, holding the left mouse button.
- Delete. Locate the cursor on the annotations to highlight a line or a point and press the **Delete** key on the keyboard, or right-click the mouse and select the **Delete** item from the context menu.
- Set render params. Locate the cursor on the label border, right-click the mouse and select the **Tool options** item from the context menu. In the dialog box that appears, set the line color, thickness for a figure and size for text. Click **YES** to apply the changes or **CANCEL** to cancel the actions.

To set the default render parameters, click on the right side of the button and select the **Paint tool settings** command. In the dialog box that appears, set the line color, thickness for a figure and size for text.

Click **YES** to apply the changes or **CANCEL** to cancel the actions.

To delete all annotations and measurements, click the **Delete all user overlay**  button on the toolbar. In the dialog box that appears, Click **YES** to delete or **CANCEL** to cancel. **Please note that all other graphic objects created manually will be deleted as well.**

4.8 Mirror Image Horizontally/Vertically

To flip image horizontally, click the  button. To flip image vertically, click on the arrow on the right side of the  button and select the  **Flip Vertically** command. If several series are opened in the view window, the mirroring is activated for each series independently.

4.9 Calibration sizes

X-ray image sizes are increased as compared with the real size of the tissues (Fig. 4.7).

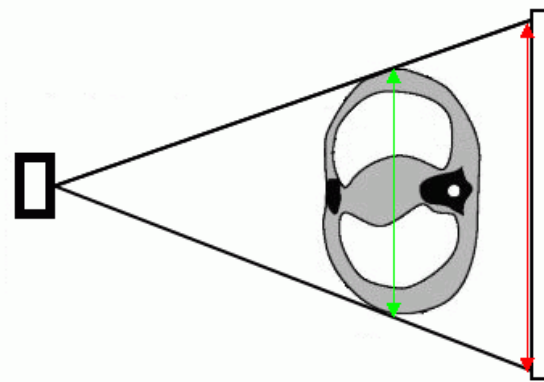





Figure 4.7: The green arrow shows the actual size of the tissues and red arrow shows the size of the image

Hence, the size determined by X-ray modality may be incorrect. If a picture contains an object whose size is known (e.g., a catheter), it is possible to calibrate the image size. To calibrate the size:

1. Click the  **Calibration** button on the toolbar with the left/right/middle mouse button. To continue work with this tool, use the button with which the tool was activated. To learn more about tool control, see Section 3.9. When the tool is activated, the cursor is displayed as . To disable the tool, click the  **Calibration** button again.
2. Mark the first point on the picture by clicking the mouse button and holding it down.
3. Drag the cursor over the screen. The calibration interval and its length will be displayed.
4. To set the second point, release the mouse button.
5. In the dialog box that appears, type the real length of the interval constructed.
 - To calibrate all the images of the series, choose the **Series** position of the switch. The images from the same study series may differ in the size of pixels. All the images of the series displayed in the current window are calibrated. As a result, the pixel size for all the images of the series is changed to reflect the actual dimensions of the object;
 - To calibrate only the current image, choose the **Current image** position of the switch.

To calibrate the size, click **Yes**, to cancel, click **Cancel**.

Calibration is factored in for measurements that depend on linear dimensions. After calibration, previously made measurements are automatically adjusted.

Calibration is maintained until the window containing the current series is open.

There are two ways to reset calibration:

- click the arrow on the right-hand side of the  **Calibration** button and select **Calibration reset**;

- left-click on the  icon in the header of the view window (see Section 3.8).

If you reset the calibration, the calibration interval remains in the image.

4.10 Synchronization by a Point

To choose the slices in all the windows that are the closest to the point selected, use the **Sync by point**  tool. To synchronize, choose a reference point in one of the viewer windows. You will see crosshairs at this point. The synchronized windows will show the slices that are the closest to the point chosen; you will see crosshairs at the closest point of the synchronized slice.





If the reference point is not present on the synchronized slice, the crosshairs shown will have a black spot in the centre

Synchronization by point is available for flat image viewer, volume reconstruction, and multiplanar reconstruction windows.

4.11 Image Synchronization

Synchronization is applied when more than one series of the same study is open in the image viewer tab. The tool allows for simultaneous viewing of images from different series. Synchronization is enabled by default.

To set up synchronization modes, proceed as follows:

1. Click the arrow on the right-hand side of the **Series sync**  button on the toolbar.
2. On the dropdown menu of the  button (Fig. 4.8), select the desired synchronization modes:

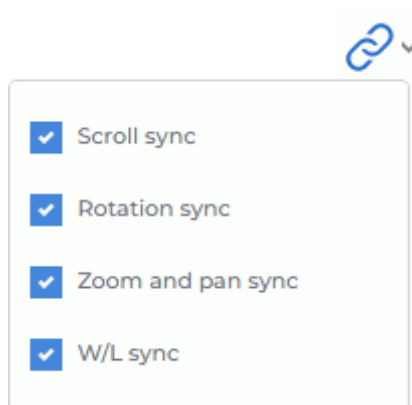

Figure 4.8: Activating the image synchronization modes

- **Scroll sync.** Allows for simultaneous scrolling of series images;



- **Rotation sync.** Allows for simultaneous rotation of series images;
- **Zoom and pan sync.** Allows for synchronization of scaling and image panning;
- **W/L sync.** Allows for synchronization of changes in window width and level (W/L) across images of different series.

4.12 Visualize Images

Color look-up tables (CLUTs) are intended for marking pixels characterized by different density with different colors in order to improve perceptibility. The colors you see on the screen do not match the actual colors.

You can choose from the following groups of CLUTs:

- relative **[WL]**;
- absolute **CT** and **XA**.

To change the CLUT click the  **CLUTs** button on the toolbar. Select **CLUTs** in the window that pops up. The current CLUT is marked with a flag. To close the CLUT window click the  button at the top right of the window.

4.13 Scout Lines

The **Show scout lines**  tool is used if two or more series are opened for a particular study. The tool allows you to display the series image scout lines in images from other series if they are in the same coordinate system.

By default, the current image scout line is highlighted in green, and the boundary scout lines are highlighted in yellow (Fig. 4.9).

If the planes of the series are parallel, scout lines are not shown on them.

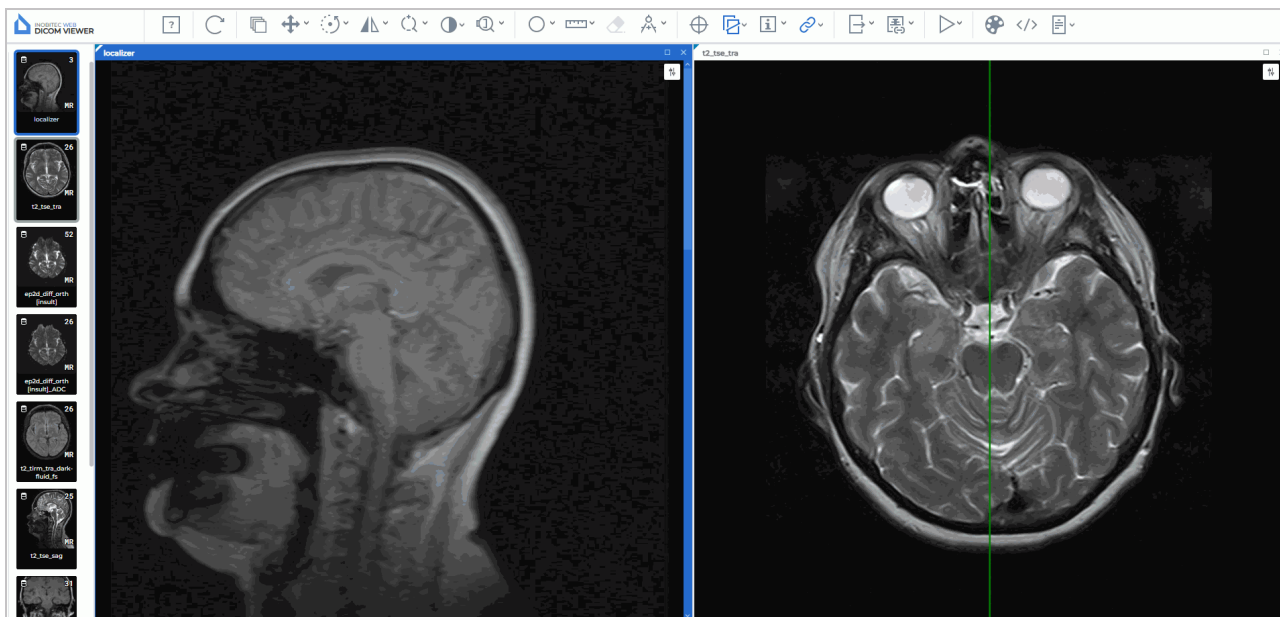



Figure 4.9: The left-hand image scout line is displayed in the right-hand image

4.13.1 The Tool Menu

The **Show scout lines**  tool menu (fig. 4.10) contains the following items:

- mode **Show all scout lines** shows the scout lines of all series images, not just of the current one;
- the **Show bound scout lines** mode shows bound scout lines;
- mode **Scout lines on selected view** shows in the current window scout lines of images opened in other windows.
- Mode **Selected view scout lines** shows the scout lines of the current image in other windows.
- **Line settings...** opens the dialog to configure the scout lines settings.

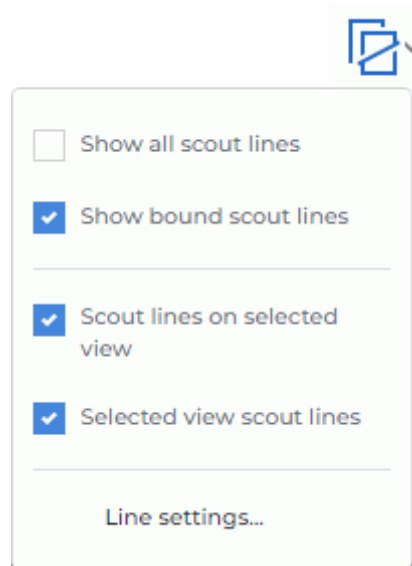



Figure 4.10: The menu for setting the scout lines display mode

To activate/deactivate the mode of this tool, click on the arrow on the right side of the  button and check/uncheck the corresponding item.

The modes are activated independently.

By default, the **Show scout lines** tool is active and all modes except **Show all scout lines** are checked.

To activate/deactivate the tool, click the  button on the toolbar.

4.13.2 Line Settings

To set the color and width of lines:

1. Click on the arrow on the right side of the **Show scout lines**  button and select the **Line settings...** item.
2. In the dialog box that appears, set the line color. To do this, left-click on the color selection area and select a color in the window that opens.
3. Set the line width between 0.1 and 100 pixels.
4. Click **YES** to apply the changes or **CANCEL** to cancel the actions.

4.14 Set Up Viewer Workspace

The **Show/hide annotations** tool allows you to display or hide the information about an image in the series windows. The settings are applied to all the series opened in the current tab.

By default, the tool is active. To activate/deactivate the tool, click the **Show/hide annotations**



button on the toolbar.

You can adjust the visibility of:

1. Orientation cube;
2. Orientation letters;
3. Render annotations;
4. Tag values.
5. Rulers.

To customize the Annotations text size, click the arrow on the right side of the **Show/hide annotations**  button, select the **Label settings** command and in the dialog that opens, enter a value. Click **Yes** to apply the changes or **Cancel** to cancel.

4.14.1 Orientation Cube

The **Orientation Cube** is located in the bottom right-hand corner (Fig. 4.11). The markers on the cube show the side the image is viewed from:

A — Anterior

R — Right

L — Left

P — Posterior

F — Foot

H — Head.

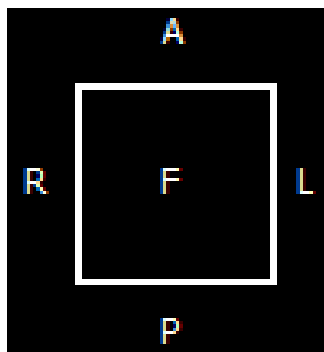

Figure 4.11: Orientation cube

If «F» is written on the cube face, it means that the image is viewed from below; if «R» is written beside a rib, it means that the patient's right side is on this side of the image.

4.14.2 Scale

A graduated scale is displayed on the right side of the window.

4.14.3 Image Information

The image information is displayed in the bottom left-hand corner. It may include the following parameters, depending on the study type:

- **Image No** — current image number in the series/total number of images in the series;
- **Image size** — image size (pixels);
- **FOV (field of vision)** — image size (millimeters);
- **Thickness** — interval between slices.

4.14.4 Patient Information

The information about the patient is displayed in the top left-hand corner.

4.15 Viewing PDF documents

Web DICOM Viewer has several modes for viewing PDF documents.

To print a document or copy the text to a text editor, open a PDF document as a text. There are three methods to do that:

1. Double-click with the left mouse button on the document thumbnail on the series panel. By default, the document will be opened in a new window as a text.
2. Select the PDF document thumbnail on the series panel and click the  **Image viewer** button.
3. Open the context menu by right-clicking on the PDF document thumbnail, and choose **Open PDF as text**.

It is more convenient to view PDF documents containing graphs, charts, and pictures as images. If you open a PDF document as an image, you can use **Zoom**, **Pan** and **Rotation** tool (see Section 4.3).

To open a PDF document as an image, open the context menu by right-clicking on the PDF document thumbnail, and choose **Open PDF as image**.

There are two ways to view the tags of the series containing a PDF document:

1. Select the PDF document thumbnail on the series panel and click the  **Open tags** button.
2. Open the context menu by right-clicking on the PDF document thumbnail, and choose **Open tags**.

If you choose **Open in tab** -> **desired tab** in the context menu, the study will be added to the series panel in the tab you have selected.

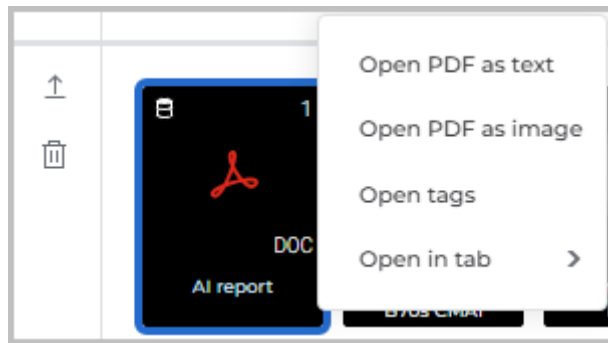

Figure 4.12: Context menu

Figure 4.13 shows a PDF document opened as an image/as a text and the DICOM tags of the series in the Web DICOM Viewer tab.

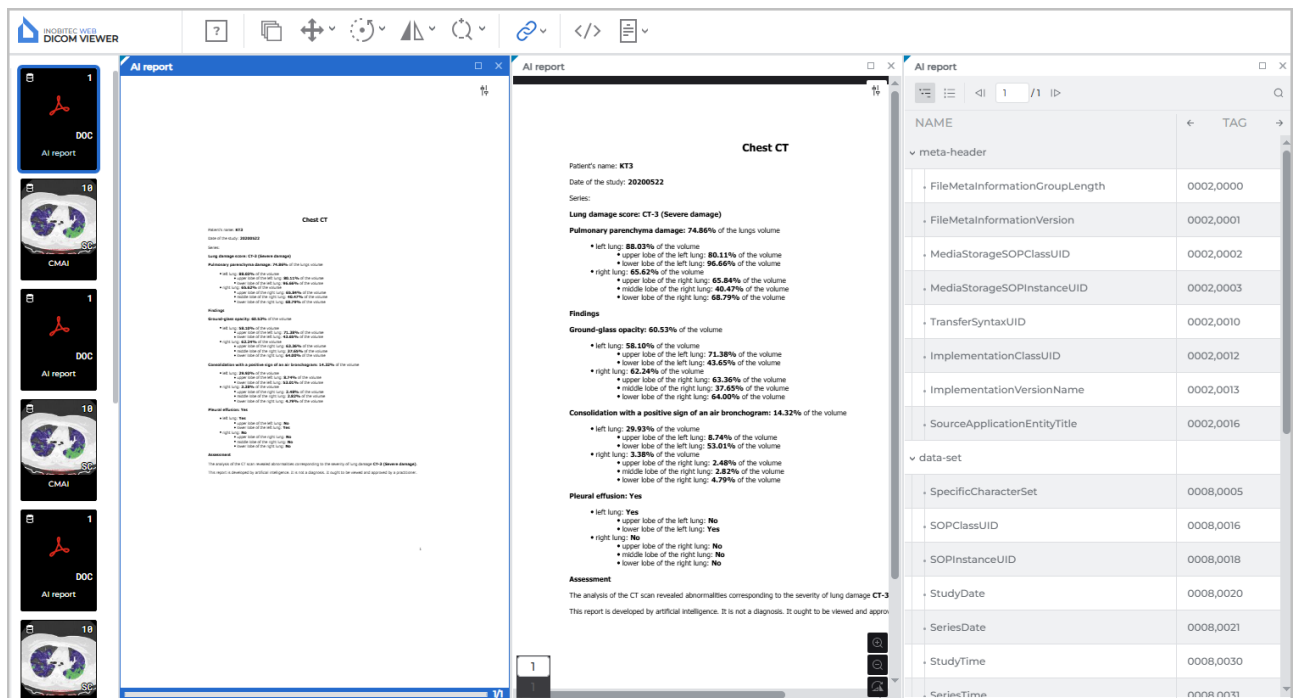

Figure 4.13: Tab Web DICOM Viewer with an open PDF document

4.16 View DICOM Tags

4.16.1 DICOM Tags. General Information

A DICOM file presents data as a sequence of elements containing information about the image (graph etc.), where the last element has the image (graph etc.) itself. Each element



comprises several parts, including:

- **Name.** If the tag name is missing, **Unknown Tag** will be displayed in the respective line;
- **Tag** — a unique element identifier comprised of a pair of values represented in the hexadecimal number system and determining the group number and the element number;
- **Data type (VR)** — a line showing the data type abbreviation (two symbols);
- **The Value Multiplicity of a data element (VM)** — specifies the number of values that may be encoded in the value field of the data element;
- **Data field length;**
- **Data text** — the information comprised in the element, including the image (graph etc.) itself. The text field in the **TEXT** column is limited in length. To view the full text, double click on the text in the row with the left mouse button. A modal window with the full text will appear.

If the tag value cannot be read, **Value not loaded** will be displayed in the **TEXT** column.

4.16.2 DICOM Tag Viewer Window

There are four ways to view DICOM tags:





1. Select the series thumbnail on the series panel and click the **Open tags**  button on the toolbar. The DICOM tag viewer window will be opened in a new tab.
2. Right-click on the series thumbnail and select the **Open tags** option in the context menu. The DICOM tag viewer window will be opened in the new tab.
3. Right-click on the series thumbnail on the series panel and select the **Open tags** option in the context menu. The DICOM tag viewer window will be opened in the current tab.
4. To view the DICOM tags of an open series, click the **Open tags**  button on the toolbar. The DICOM tag viewer window for the current series will be opened in a pop-up box.

The DICOM tag viewer window is shown in Fig. 4.14.



| NAME | TAG | VR | VM | LENGTH | TEXT |
|------------------------|-----------|----|----|--------|----------------------------------------------------------------|
| meta-header | | | | | |
| v data-set | | | | | |
| - SpecificCharacterSet | 0008,0005 | CS | 1 | 10 | ISO_IR 192 |
| - ImageType | 0008,0008 | CS | 3 | 26 | ORIGINAL\PRIMARY\LOCALIZER |
| - SOPClassUID | 0008,0016 | UI | 1 | 26 | 1.2.840.10008.5.1.4.1.1.2 |
| - SOPInstanceUID | 0008,0018 | UI | 1 | 64 | 1.2.826.0.1.3680043.10.404.10839436188441809619228367094767... |
| - StudyDate | 0008,0020 | DA | 1 | 8 | 20120412 |
| - SeriesDate | 0008,0021 | DA | 1 | 8 | 20120412 |
| - AcquisitionDate | 0008,0022 | DA | 1 | 8 | 20120412 |
| - ContentDate | 0008,0023 | DA | 1 | 8 | 20120412 |
| - StudyTime | 0008,0030 | TM | 1 | 10 | 122613.211 |

Figure 4.14: DICOM tag viewer window

At the top of the DICOM tag viewer window, you can see the current file number and the total number of files. The file number in the DICOM tag viewer window may not match the image number in the series viewer window. Synchronization of the images in the series viewer window with the files in the DICOM tag viewer window is performed with the image UID. There are three ways to switch to the tags of another file:

- with the help of  and  buttons on the toolbar;
- with the help of the  and  cursor control keys;
- by entering a numeric value in the input field.

The tag display options may be changed from the drop-down list on the toolbar:

- **Full.** Set by default. All the columns with tag parameters are displayed in the window;
- **Compact.** All the columns except the column with the tag name are displayed as one (Fig. 4.15). Next to the name of the column, you will see the navigation buttons you can use to go to the previous  and the next  column.

When the window is reduced (≤ 768 pixels) e.g. when series are arranged in a grid, the tag view mode is automatically switched to **Compact** type. If the window size is >768 pixels, the tag view mode is automatically switched to **Full** type.

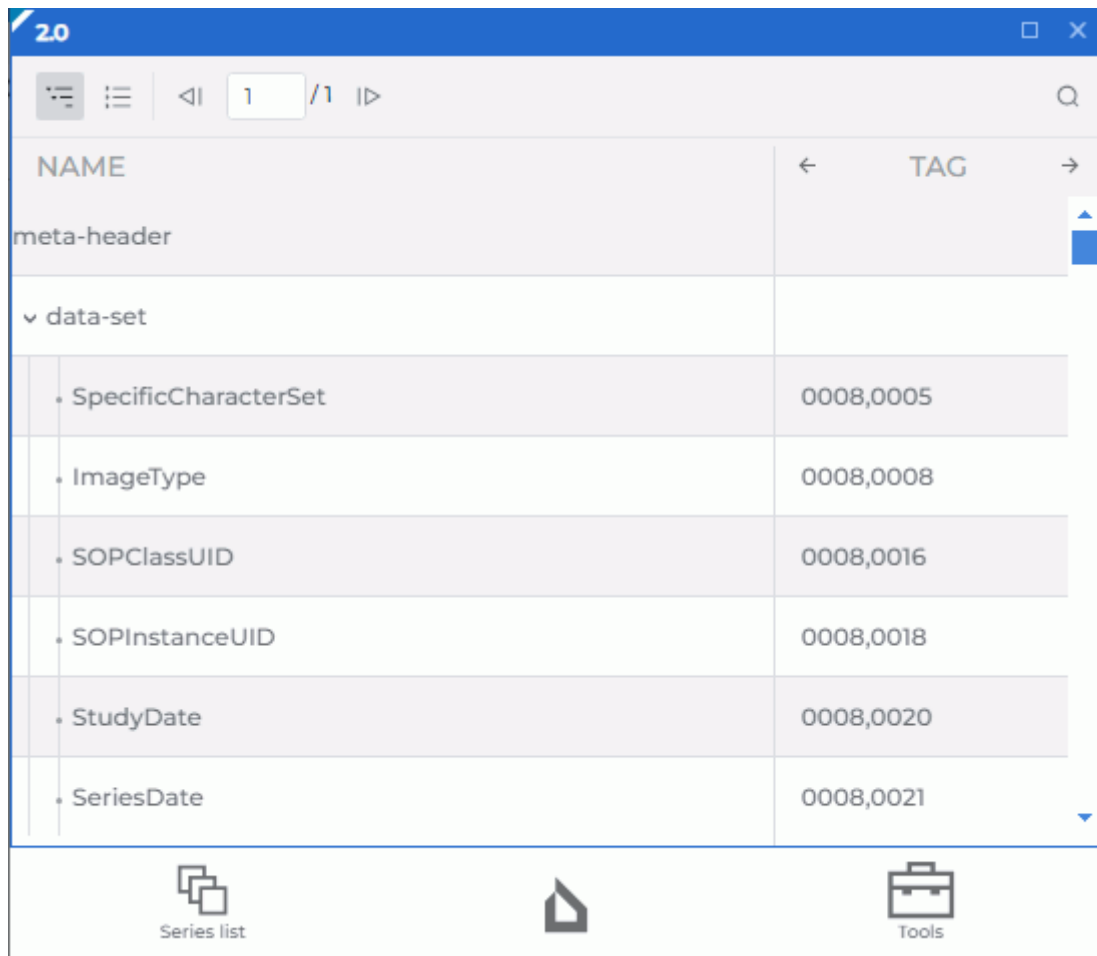





Figure 4.15: Reduced DICOM tag viewer window

DICOM tags cannot be edited. The user can copy text from the tag viewer window to the clipboard.

To maximize the DICOM tag viewer window, double-click on the window header with the left mouse button or click the  button in the upper right corner of the series window.

To restore the original size of the DICOM tag viewer window, double-click on the window header with the left mouse button or click the  button in the upper right part of the window.

To close the DICOM tag viewer window, click the  button in the upper right part of the window.

4.16.3 Toolbar

The toolbar is placed in the upper part of the window (Fig. 4.16).

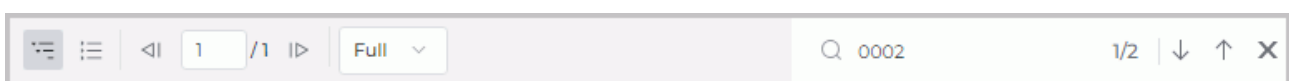

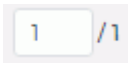











Figure 4.16: Toolbar

Tools:

| | |
|-------------------------------------------------------------------------------------|----------------------------------------------------------------------------------------------------------------------------------------------------------------------------------------------------------------------------------------------------------------------------|
|  | The Expand all button shows the tag tree. |
|  | The Collapse all button is used to collapse the tag tree. |
|  | The file indicator shows the current file number and the total number of files in the series. The number is assigned to the file by the modality, and it may be different from the sequence number of the file shown in the DICOM tag viewer window. |
|  | The button navigates you to the previous file of the series. |
|  | The button navigates you to the next file of the series. |
| | The View mode drop-down list allows for the selection the Full or Compact view mode of the tag window. By default the Full mode is activated. When the window is resized, the view mode changes automatically. For details see Section 4.16.2. |
|  | Opens search panel. To perform a search, print some text in the Search... field. For details see Section 4.16.5. |
|  | The Next element button. The button is used to go to the next search result. |
|  | The Previous element button. The button is used to go to the previous search result. |
|  | The Close button closes the search panel. |

4.16.4 Tag Tree

The tag tree is placed under the toolbar. If several tags belong to the same group, the group is unfolded and the tags are shown. Groups can be nested, one inside another. To unfold a group, click on the  button to the left of its name, to collapse a group, click on the  button. To expand all the groups, click on the  **Expand all** button on toolbar;

to collapse all the groups, click on the  **Collapse all** button.

4.16.5 Search





To open the search panel, click the  button on the toolbar. The search panel will be displayed at the bottom of the window. To close the search panel, click the  button on the right or the search panel. The search panel is shown in Fig. 4.17.



Figure 4.17: The search panel in the DICOM tag viewer window

You can perform search by any data contained in the element. To perform search, enter the text you need to find in the **Search...** field. The elements with fully or partially matching values will be highlighted in DICOM tag viewer window. In the search field, you can see the number of the current match and the total number of matches found. To go to the next element found, click the  button, to go to the previous element, click the  button.

4.17 Viewing Structured Reports

4.17.1 General Information about Structured Reports

Structured reports are used for transferring and storing structured medical documents.

A structured report contains information on the patient and the study. Series of structured reports have **SR** modality.

4.17.2 Structured Reports Viewer Window

There are three ways to view a structured report:

1. Double-click on the series thumbnail placed on the series panel.
2. Select the series thumbnail on the series panel and click the  **Image viewer** button.
3. Right-click on the series thumbnail and choose the **Open in SR** option on the context menu.

The structured reports viewer window is shown in Fig. 4.18.

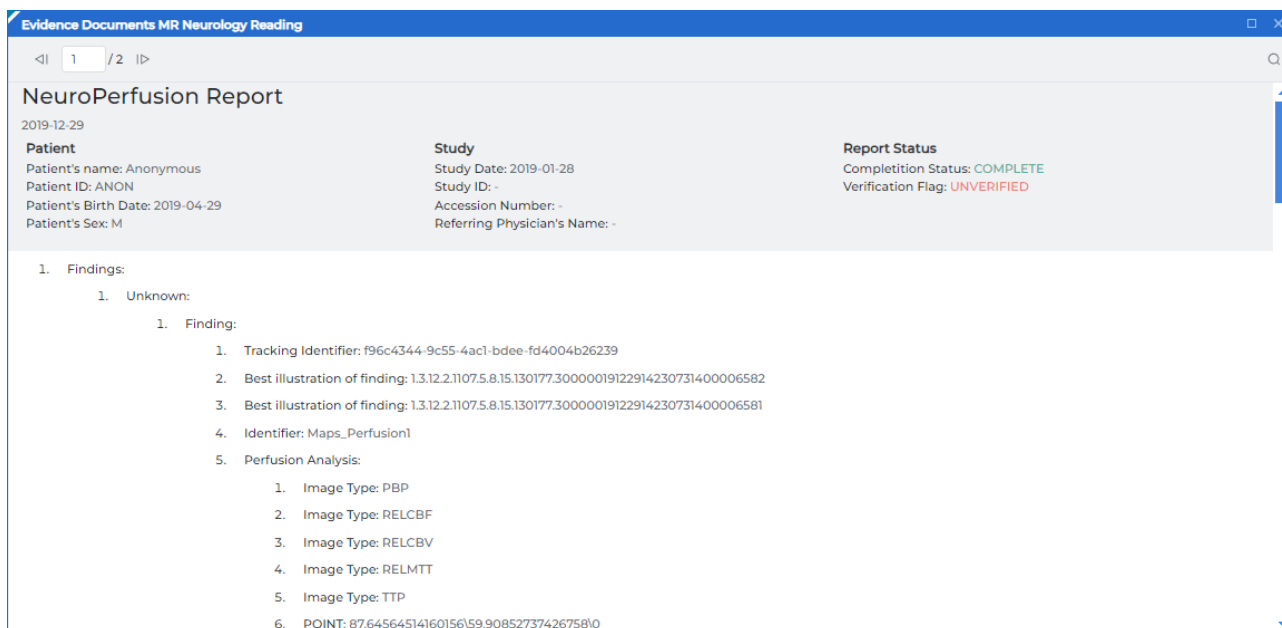



Figure 4.18: Structured Reports Viewer Window

General information on the patient is provided at the top of the structured reports viewer window. It is arranged in three columns: **Patient**, **Study** and **Report Status**. When the window is reduced (≤ 768 pixels) e.g. when series are arranged in a grid, all the columns with general information are displayed as a vertical option box (see Fig. 4.19). To get the details, left-click on the **Patient**, **Study** or **Report Status** option.

The number of the current document and the total number of documents is displayed at the top of the viewi window. The order of the documents depends on the names of the files containing such documents. There are three ways to switch between documents:

- with the help of  and  buttons on the toolbar;

- by entering a numerical value into the input field.

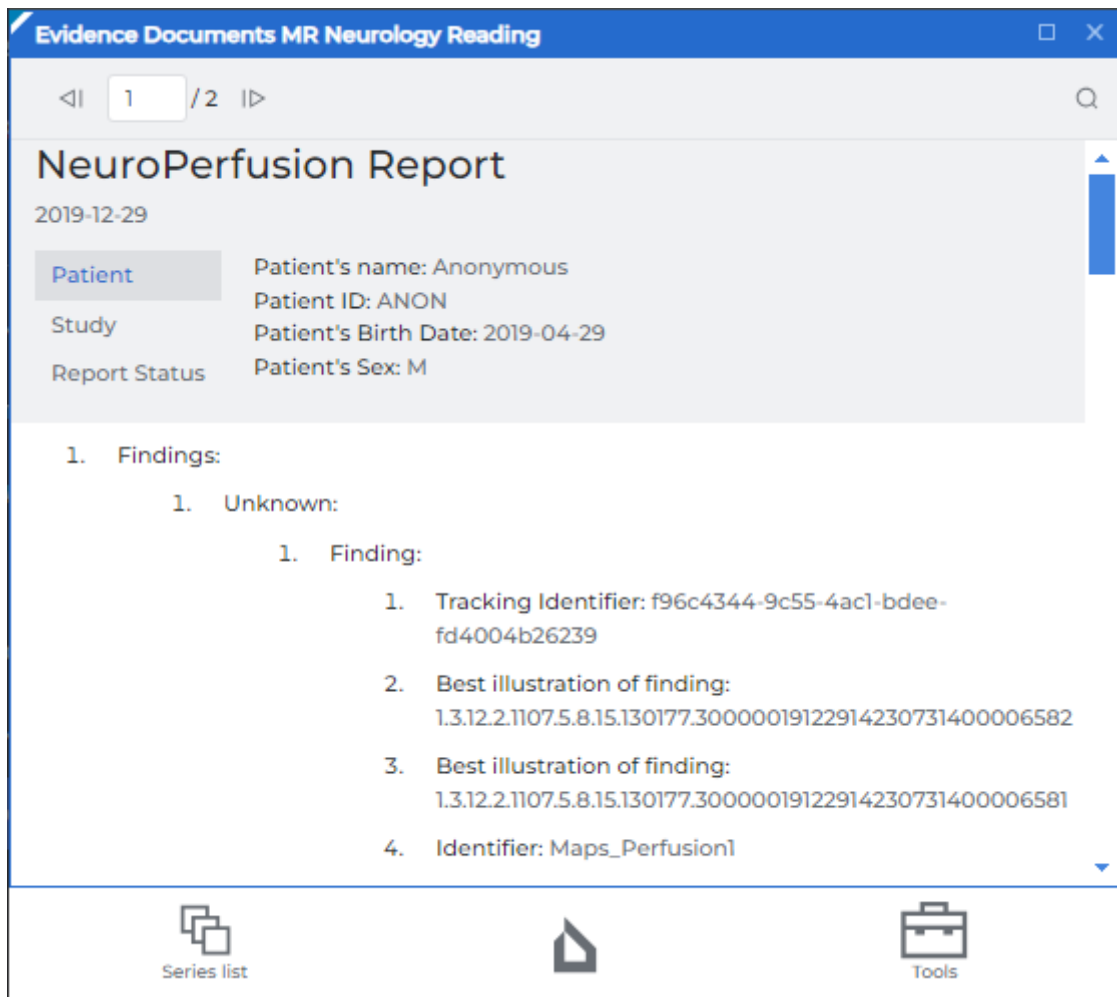





Figure 4.19: Reduced structured reports viewer window

In the lower part of the window, structured information is displayed. Structured reports cannot be edited. The user can copy text from the structured reports preview window to the clipboard.

To maximize the structured report viewer window, double-click on the window header with the left mouse button or click the  button in the upper right corner of the series window.

To restore the original size of the structured report viewer window, double-click on the window header with the left mouse button or click the  button in the upper right part of the window.

To close the structured report viewer window, click the  button in the upper right part of the window.

4.17.3 «Search» Field





To open the search panel, click the  button on the toolbar. The search panel will be displayed at the bottom of the window. To close the search panel, click the  button on the right or the search panel. The search panel is shown in Fig. 4.20.



Figure 4.20: Search panel in the structured report viewing window

You can perform search for any data contained in the element. To perform search, enter the text you need to find in the **Search...** field. The elements that match the character combination at least partially will be highlighted. In the search field, you can see the number of the current match and the total number of matches found. To go to the next element, click the  button. To go to the previous element, click the  button.

If the window is reduced, search can only be performed for the visible part of the information — by the description of the highlighted title of general information in the upper part of the window and the structured information in the lower part.

4.18 Watching Videos

The Web DICOM Viewer allows for viewing DICOM series containing videos.

To watch a video, open the appropriate series (see Section 3.6). The video player control panel will be displayed in the viewer window (Fig. 4.21).

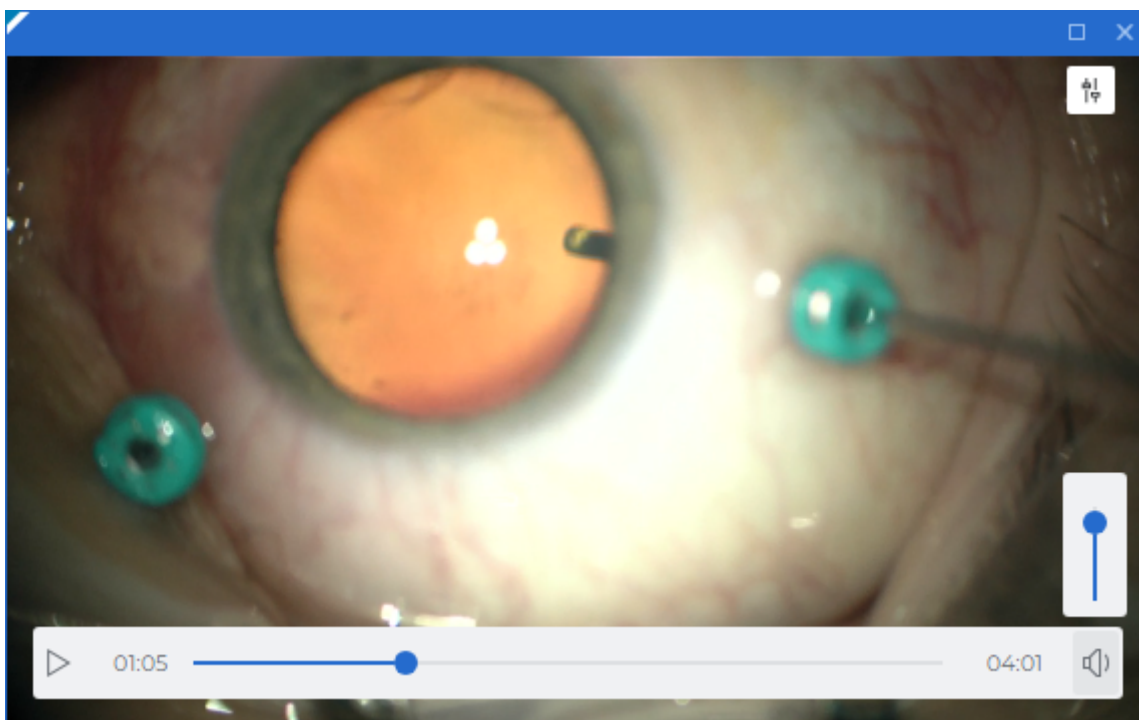







Figure 4.21: Watching videos

Warning! If the study or series containing the video is located on a PACS server, you must download the selected series or the study containing the selected series to the user's storage in order to view the video.

To start video playback, click the **Play**  button on the video player control panel.

To pause the video, click the **Pause**  button on the control panel. To go to a specific playback time, click the left mouse button on the timeline or move the current time indicator slider.

To adjust the playback volume, hover the mouse over the volume indicator  and move the vertical volume adjustment slider. To mute the sound, left-click on the  button.

The button will change its shape to . To unmute, left-click on the  button.

To hide the video player control panel, move the mouse cursor outside the viewing window. To bring the control panel back, move the mouse cursor into the viewing window again.

4.19 Export series

4.19.1 Export to DICOM

The function of Exporting to DICOM allows you to export the current image to a series saved within the same study as a new series. To export an image, follow these steps:

1. Click on the arrow on the right side of the **Quick image export**  button on the toolbar and select the **Image export** item.
2. In the **Image export** dialog box select the **Export to DICOM** tab (Fig. 4.22).

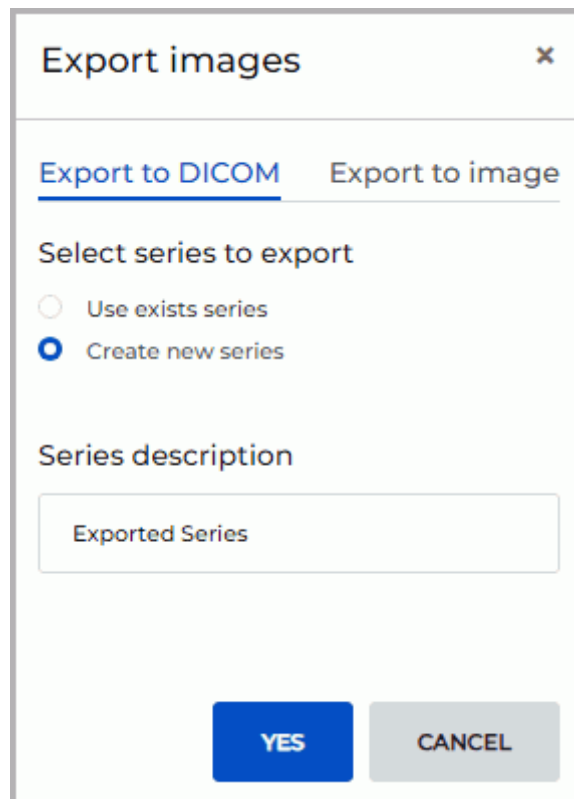

Figure 4.22: Export to DICOM dialog box

3. Select the series to export. If no series has been exported yet, only the **Create new series** item will be available. If an export has been conducted before, you can export the data to the last created series by selecting the **Use exists series** option.
4. Enter a series description. A series description can be entered if the user is creating a new series. The maximum length of a description text is 64 characters. The default series description is *Exported Series*.
5. To initiate export, click **YES**. To cancel the export, click **CANCEL**.

To continue exporting images to the DICOM format with the current settings, click on the **Quick image export**  button or press **Ctrl+S**.

Export to DICOM is available in the **Image viewer**, **Volume reconstruction**, **MPR reconstruction**, and **ECG viewer** windows.

4.19.2 Export to Image

The export to image allows you to export the current image to a *.bmp*, *.png*, or *.jpg* file. To export data to an image:

1. Click on the arrow on the right side of the **Quick image export**  button on the toolbar and select the **Image export** item.

- In the **Image export** dialog box select the **Export to image** tab (Fig. 4.23).

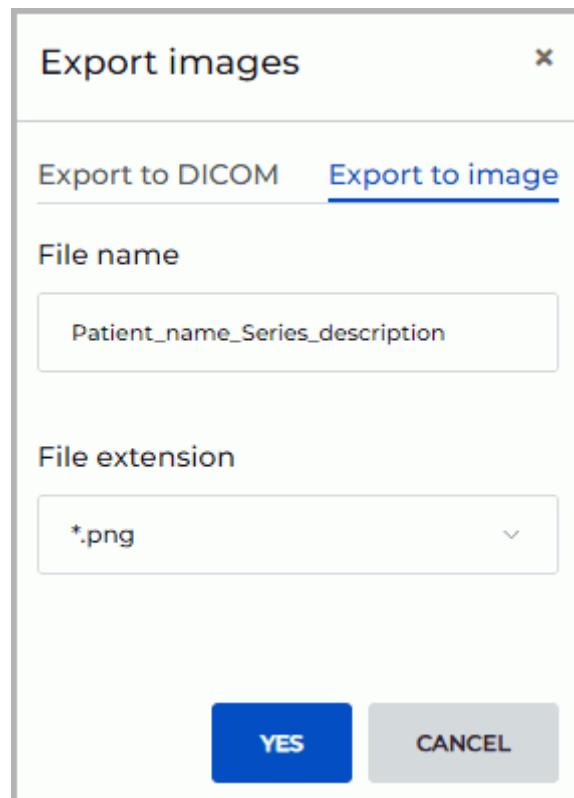



Figure 4.23: Export image to file dialog box

- Specify the file name. The maximum length of a file name is 64 characters. By default, the file name has the following form *<Patient name>_<Series description>*. During export, special characters and spaces in the file name will be automatically replaced with the underscore symbol «_».

- Select the file extension from the drop-down menu.

In the Chrome web browser, the *.bmp format is not available on the list because export to files with the *.bmp extension is not supported in this browser. If the *.bmp extension was previously saved in the settings and the user is working in the Chrome web browser, the *.png format will be chosen by default when the **Quick image export**  button is pressed.

- To initiate export, click **YES**. To cancel the export, click **CANCEL**.

To continue exporting images to a file with the current settings, click on the **Quick image export**  button or press **Ctrl+S**.

Export to image is available in the **Image viewer**, **Volume reconstruction**, **MPR reconstruction**, and **ECG viewer** windows.

Chapter 5

Volume Reconstruction



In the volume reconstruction window, a diagnosis may only be established on the basis of analysis of the series with CT, MR, MG, or XA modality.



The Web DICOM Viewer supports 16-bit image format. If the quality of the original image is higher, some of the information will be lost.

5.1 Viewing Series in the Volume Reconstruction Window

Open the series in the volume reconstruction window (see section 3.6). The volume reconstruction window is shown in Fig. 5.1.

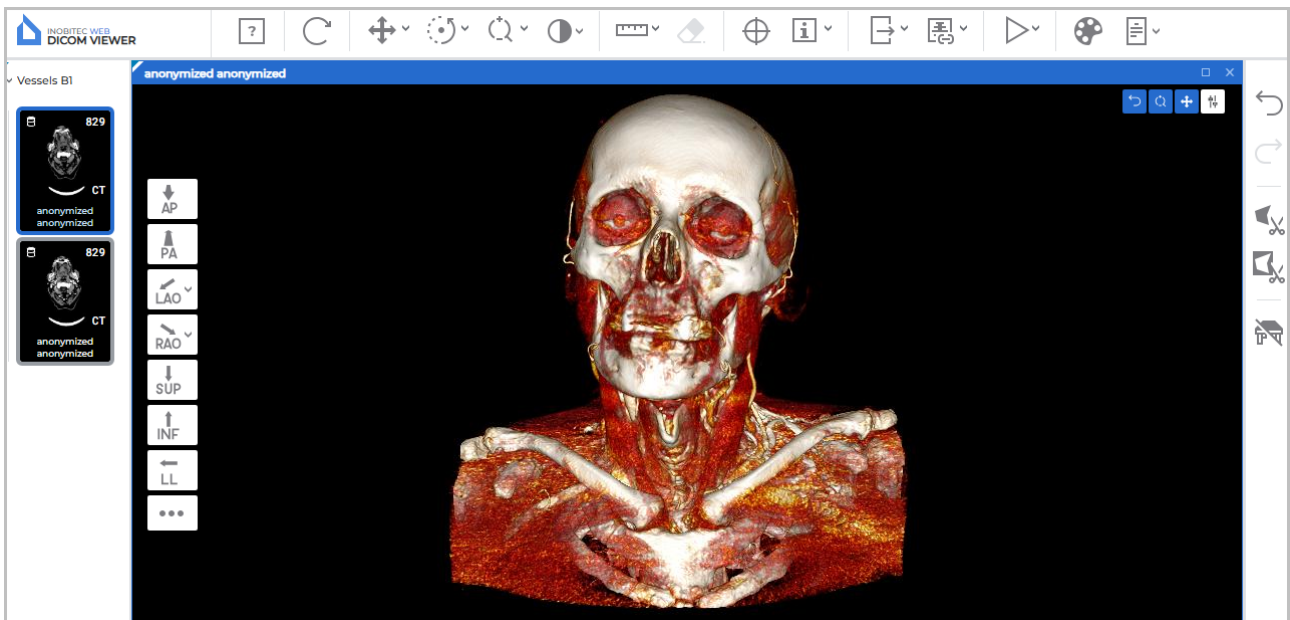

Figure 5.1: The volume reconstruction window

On the left-hand side of the volume reconstruction window, there is a standard space ori-

entation panel. On the right-hand side, there is a volume editing toolbar panel. For multiphase and multiframe series containing phases and/or frames, a horizontal scroll bar is displayed at the top of the window.

5.2 Model Orientation in Space

On the left-hand side of the window, you can see a standard space orientation panel (Fig. 5.1). The standard space orientation panel is displayed in each open volume reconstruction window. By clicking the buttons on the panel, you can only work with the window in which the panel is placed.

To jump to a different space orientation option, click the buttons on the panel. To open additional options for the **LAO** and **RAO** buttons, click the arrow on the right side of the corresponding button. The selected additional orientation options are saved and applied for each user individually. When the window size is small (≤ 1000 pixels), additional orientation options for the **LAO** and **RAO** buttons are unavailable.

A hotkey can be assigned to each space orientation option (see Section 2.4). Hotkeys change the model position in space only in the active window. By default, hotkeys are not assigned.

5.3 Model Positioning Tools

To activate/deactivate the tool click the tool button with the left/right/middle mouse button. To continue work with this tool, use the button with which the tool was activated. To learn more about tool control, see Section 3.9.

The **Pan** tool allows you to model holding down the mouse button. To activate/deactivate tool click the  button on the toolbar.

The **Rotation** tool allows you to model holding down the mouse button. To activate/deactivate tool click the  button on the toolbar. Note that the initial point of the cursor does not affect the rotation. If the cursor is moved vertically, the image is rotated round the horizontal axis. If the cursor is moved horizontally, the image is rotated round the vertical axis. That is, the image follows the cursor. If the cursor moves along a slanting line, the image slants the same way.

The **Zoom** tool allows you to model holding down the mouse button. To activate/deactivate tool click the  button on the toolbar.

5.4 Measurement tools

The following tools are used to measure various parameters in the volumetric reconstruction window: **Distance measurement ruler**, **Distance measurement polyline** and **Angle measurement**. To select one of these tools, click on the arrow on the right side of the tool selection button. From the drop-down list, select and activate the desired tool with the left, right or middle mouse button. To continue work with this tool, use the button with which the tool was activated. To learn more about tool control, see Section 3.9.

5.4.1 Distance measurement ruler tool

The function of the tool is similar to that in the flat image viewer window (see Section 4.6). The difference is that in the volume reconstruction window, it is not possible to move the built measurement line as a whole. In the volume reconstruction window, the measurement line is always visible, even if it is placed behind the model.

5.4.2 Distance measurement polyline tool

The function of the tool is similar to that in the flat image viewer window (see Section 4.6). The difference is that in the volume reconstruction window, it is not possible to move the built polyline as a whole. In the volume reconstruction window, the polyline measurement is always visible, even if it is placed behind the model.

5.4.3 Angle measurement tool

The function of the tool is similar to that in the flat image viewer window (see Section 4.6). The difference is that in the volume reconstruction window, it is not possible to move the angle measurement as a whole. In the volume reconstruction window, the angle measurement is always visible, even if it is placed behind the model.

5.5 Model Playing

The Web DICOM Viewer allows you to automatically rotate a volume model around one of the vertical axes relative to the center. The tool is described in Section 4.2.

5.6 Visualization Settings

To change the way the 3D model is displayed in the volume reconstruction window, change the color lookup table (see Section 4.12).

If an absolute CLUT (**CT** or **XA**) is selected in the volume reconstruction window, the window width and level values (**W/L**) cannot be changed.

5.7 Cutting Tools

In the volume reconstruction window, the right sidebar shows the volume editing tools (Fig. 5.2).





Figure 5.2: 3D Model editing tools

The tools for editing 3D models are displayed on the sidebar only if at least one volume reconstruction window is open. If the volume reconstruction window is inactive, the volume editing tools are unavailable.

To activate/deactivate the tool click the tool button with the left/right/middle mouse button. To continue work with this tool, use the button with which the tool was activated. To learn more about tool control, see Section 3.9.

5.7.1 Undo and Redo tools

To undo or redo the last action associated with cutting, use the **Undo**  and **Redo**  buttons.

To undo all actions, click the **Restore original view**  button on the toolbar. **Note that all other changes are reset at the same time.**

5.7.2 Polygonal cut

The **Polygonal cut**  tool allows you to build a polygon or an area with smooth borders that the cut area is projected on. The outline and the inner area of the figure built are shown in red.

To build a polygon:

1. Activate the **Polygonal cut**  tool.

2. Click the mouse button to set the apices of the polygon marking the figure to be cut, except the last point.
3. Fix the last point by double-clicking the mouse.
4. To cancel an incomplete building, press **Esc** on the keyboard.

To build an area with smooth borders (Lasso mode):

1. Activate the **Polygonal cut**  tool.
2. Press and hold the **Shift** key on the keyboard.
3. Circle the area to be cut, holding down the mouse button.
4. To complete the building, release the mouse button or click another mouse button.
5. To cancel an incomplete building, press **Esc**.

The part of the model to be projected on the area will be cut.

5.7.3 Inverse polygonal cut

The tool is similar to the previous one, except that the part of the model not to be projected on the area will be cut. The outline and the inner area of the figure built are shown in green.

To activate/deactivate the tool, click on the **Inverse polygonal cut**  button.

5.7.4 Remove table tool

The tool allows you to delete areas resembling the medical equipment table. To delete, click the **Remove table**  button on the right side toolbar.



Some objects that have been misrecognized as the modality table may be deleted by mistake.

Chapter 6

Multiplanar Reconstruction (MPR)

6.1 View Images

There are two ways to open a series in the MPR reconstruction mode:

- select a study series on the series panel and click the  **MPR reconstruction** button;
- open the context menu for the series thumbnail by right-clicking and select the **Open in MPR** option.

Fig. 6.1 illustrates the multiplanar reconstruction window.

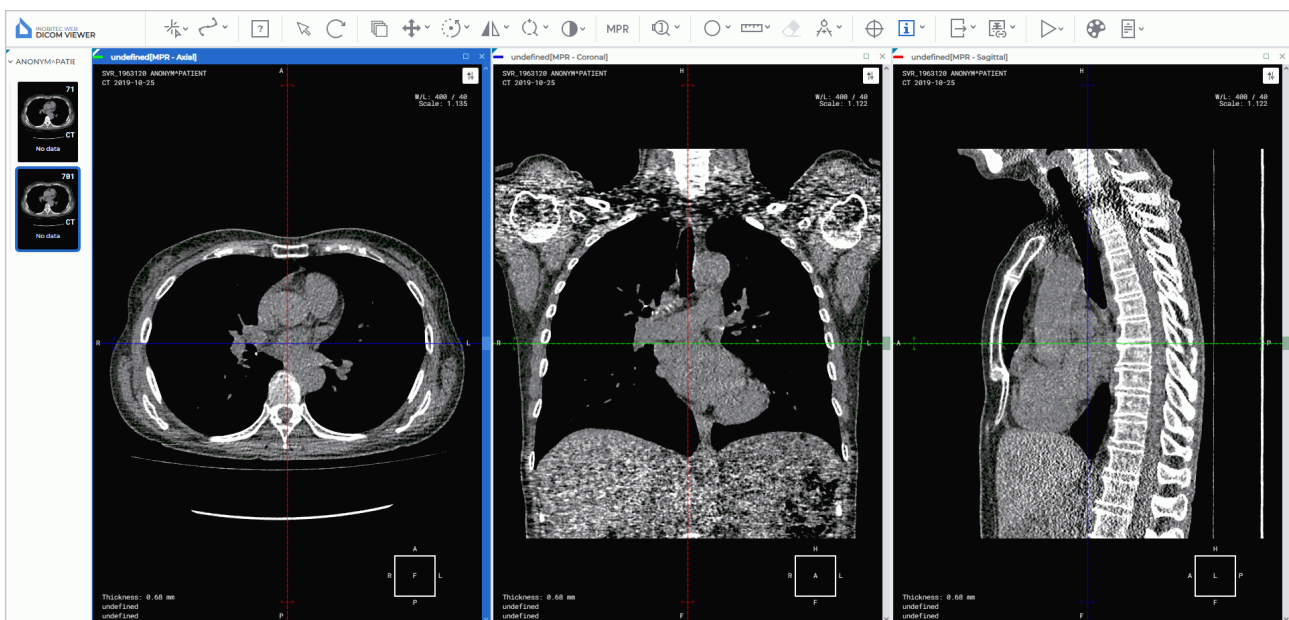

Figure 6.1: Multiplanar reconstruction tab

The series will be opened in a new tab. There will be three image viewing windows: one with the axial plane, one with the frontal plane, and one with the sagittal plane.

View images in the MPR windows is similar to view flat images. To move to the another image, rotate the mouse wheel or use the scroll bar on the right side of the window.

For multiphase and multiframe series containing phases and/or frames, horizontal scroll bars (synchronized with each other) are displayed at the top of each window.

To expand any section plane window of the **MPR reconstruction** tab and restore its size, double-click with the left mouse button on the window header.

6.2 Reconstruction Modes. Slice Thickness

6.2.1 Render Modes

To switch between modes, the **MPR modes** **MPR** button on the toolbar is used. On the button, you can see the name of the mode. To change the mode, click the **MPR modes** button and select the mode in the window that pops up (see Fig. 6.2).

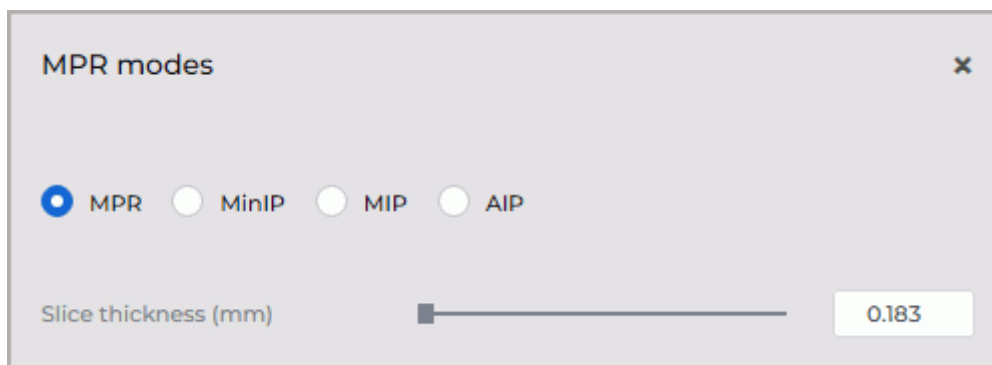

Figure 6.2: The window for reconstruction mode selection

Four render modes are available:

1. The **MPR** mode. Sections are available for viewing. Set by default.
2. The **MIP** mode . A slice of a particular thickness is viewed instead of a section. A point with maximum intensity in the slice is projected on each point in the image. For details on how to set the thickness, see the next section.
3. The **MinIP** mode . Similar to the previous mode, but points with minimum intensity are projected on the image.
4. The **AIP** mode. Similar to the previous mode, but the intensity of each point equals the average intensity of the points projected on this point in the image.

6.2.2 Slice Thickness

In the **MIP**, **MinIP** and **AIP** render modes, the slice thickness is set using the **MPR modes** window (Fig. 6.2). Click the **MPR modes** button and type the value or move the slider to change the value. In the projection window, the slice borders are marked by dotted lines.

6.3 Working with Orthogonal Planes

6.3.1 View navigation modes

In the Web DICOM Viewer, there is a function of switching between cutting plane display modes.

To select one of the display modes, click on the arrow on the right-hand side of the **Switch navigation mode** button or on the button itself. From the dropdown menu, choose one of the 3 display modes (Fig. 6.3):

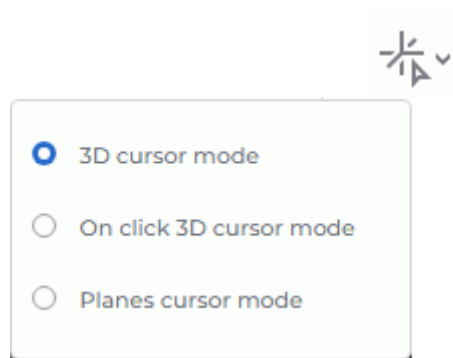
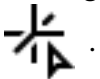

Figure 6.3: 3D cursor mode selected

1. The **3D cursor mode**. Provides an opportunity to move the intersection of orthogonal cutting planes to a particular point with a mouse click, as well as to rotate orthogonal cutting planes with the mouse. The **Switch navigation mode** button will look as follows:



In order to move the intersection of cutting planes, move the cursor to the desired point on the image and click the left mouse button.

If some active tool is assigned to the left mouse button, the function of moving the intersection of planes to a certain point is blocked.

2. The **On click 3D cursor mode**. Provides an opportunity to move the intersection of orthogonal cutting planes to a particular point with a mouse click, similar to the 3D cursor mode, but the lines of the planes are only visible on the screen during movement (when the left mouse button is pressed). The **Switch navigation mode** button will look as follows:



If some active tool is assigned to the left mouse button, the function of moving the intersection of planes to a certain point is blocked.

3. The **Planes cursor mode**. The cutting planes are displayed permanently. This mode is used for moving and rotating cutting planes. The **Switch navigation mode** button will look as follows:

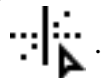

In order to move the cutting planes to the desired spot, hover the mouse over the plane line. The line is highlighted when the cursor is placed on it. Move the mouse while

holding down the left button. Release the mouse button to fix the plane in its current position.

If some tool is assigned to a mouse button, when the cursor is placed on the plane line or on the arrow, the planes will be moved and rotated with that mouse button. Beyond the plane line, the tool assigned to the mouse button will be active.

In all the view modes the current plane can be moved in several ways:

- Scroll the mouse wheel. If you scroll the wheel forward, the plane will withdraw, if you scroll it backward, the plane will move nearer. One click of the mouse wheel changes the plane position by the distance equal to the thickness of the slice from the initial series.
- By use the scrollbar on the right side of the section view window to move the section.

To rotate a plane while maintaining orthogonality:

1. Locate the cursor on the radial bidirectional arrow on the plane line (see red arrows in Fig. 6.4). The bidirectional arrow will be highlighted.
2. Move the cursor, holding the mouse button to rotate the plane by the required angle. The images on the other planes change.
3. Release the mouse button to fix the current position of the plane.

To undo the rotation of all planes, click the **Restore original view**  button on the toolbar. **Note that all the other changes made with the tools used for editing images will also be canceled.**

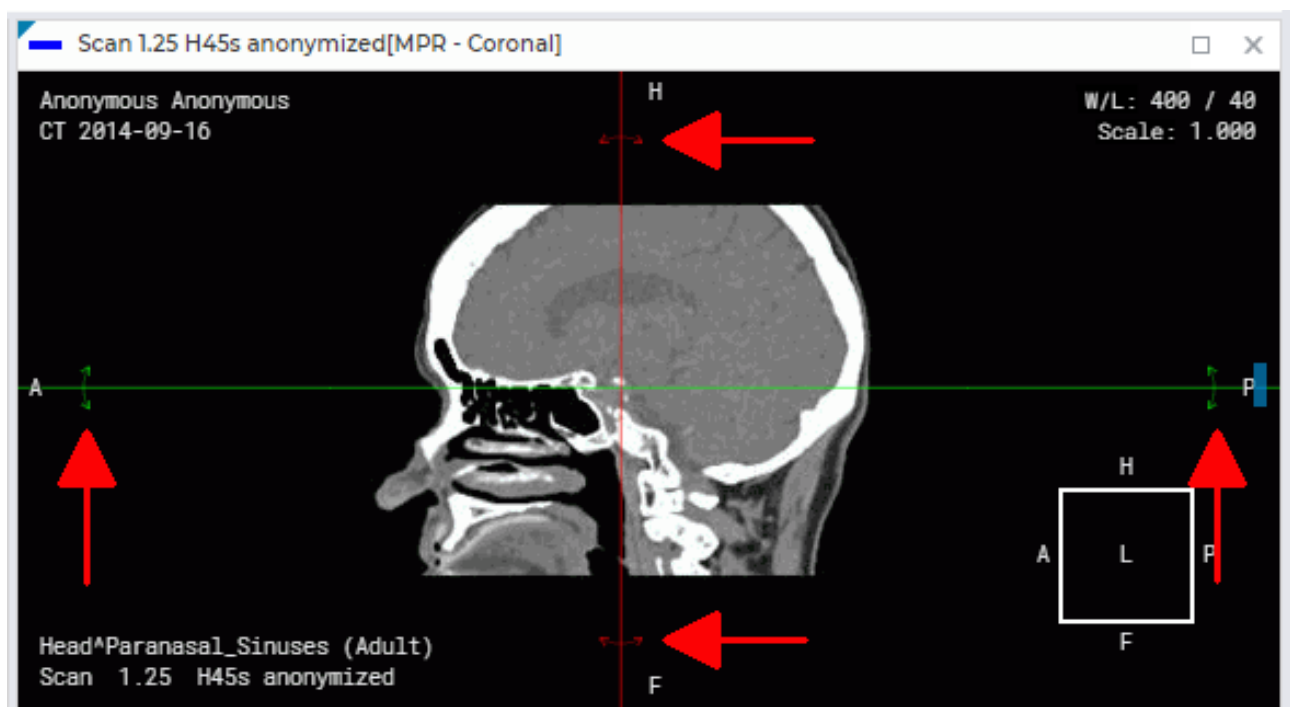





Figure 6.4: Rotate an orthogonal plane

6.4 Curvilinear Reconstruction. Build Surface

Curvilinear reconstruction is a section of tissues by a curvilinear surface whose configuration is set by the trajectory passing through the middle of this surface. This trajectory is called a **curve**.

To activate the Curvilinear reconstruction mode, click the **Curvilinear reconstruction mode**  button with the left, right, or middle mouse button. To work with this tool, use the button with which it was activated. You will find the details concerning the use of the tools in Section 3.9. When the tool is activated, the cursor looks like . To deactivate the tool, click the **Curvilinear reconstruction mode**  button again.

To build a surface:

1. Select the plane in which it would be convenient to start building a curve.
2. Roll the mouse wheel to select the slice where the first point of the curve should be located.
3. Fix the first point on the image by clicking the mouse button with which the tool is activated.
4. If necessary, move to another slice by rolling the mouse wheel.
5. Move the mouse to select the location of the next point. Fix the point by clicking the mouse button with which the tool is activated. A curve is drawn between the points.
6. Repeat Step 4 and 5 until the last but one point is fixed. While building the curve, the current section will be displayed in the **MPR - Curved surface** window (Fig. 6.5).
7. Fix the last point by clicking the mouse twice.
8. If necessary, correct curve. Points on the curve can be edited in all the cutting plane windows. For details on how to correct, see the section 6.4.2.

To cancel the curve that has not been completed, press **Esc** on the keyboard.

By the color of the curve, you can determine which part of the curve is located in front of the current image in space. This part of the curve is brighter than the part behind the image.

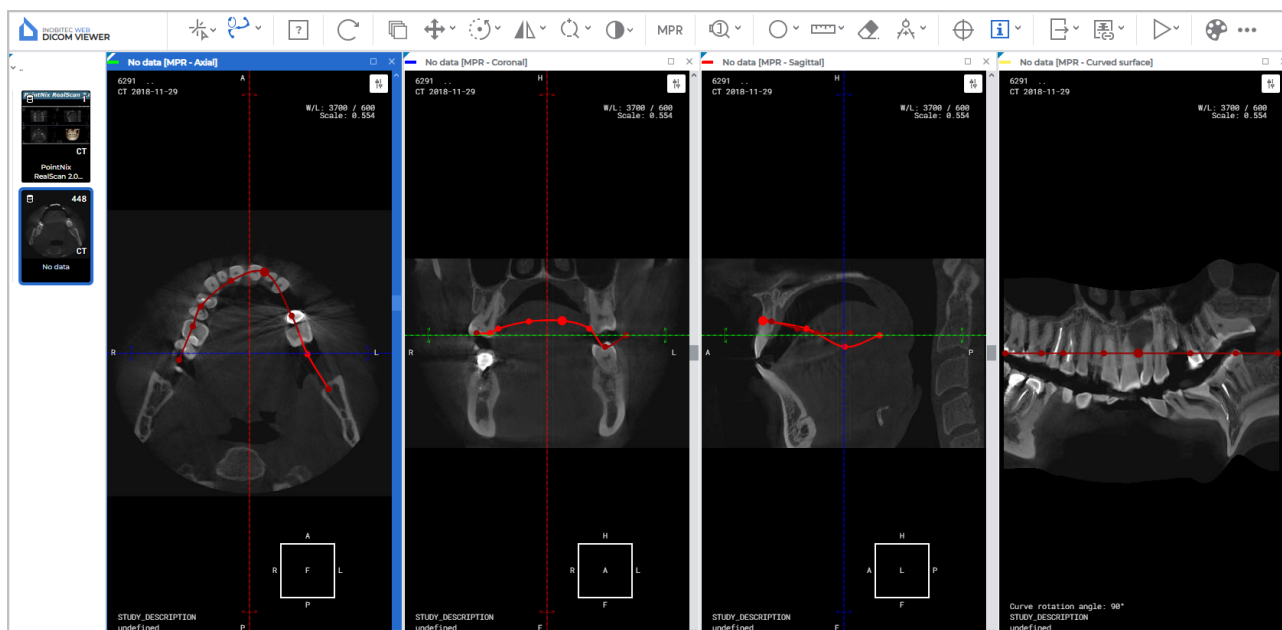

Figure 6.5: Reconstruction by a curve

In the left-hand bottom corner of the **MPR - Curved surface** window, in the **Curve rotation angle** field, you see the current value of the section rotation angle (in degrees).

There are two ways to rotate a section with a surface in the **MPR - Curved surface** window:

- by rotating the mouse wheel. When you scroll up, the section is rotated by a positive angle. When you scroll down, the section is rotated by a negative angle. One click of the mouse wheel changes the rotation angle by one degree;
- with the help of the scroll bar on the right-hand side of the window. Move the slider up to rotate the section by a positive angle or down to rotate it by a negative angle.

A section with a surface built around the curve may be rotated within the range of -180° to $+180^\circ$. Cyclic rotation is available when the **Play** tool is activated with the active **Replay** command. For details see Section 4.2.

To escape the curvilinear reconstruction mode, close the **MPR - Curved surface** window or one of the section plane windows.

6.4.1 Curve settings

The parameters of the curve can be set in the **Curve settings** dialog box (Fig. 6.6). The functions of the **Curve settings** dialog box depend on the way you call for it. There are two ways to call for the **Curve settings** dialog box:

1. Click the arrow on the right-hand side of the **Curvilinear reconstruction mode** button on the toolbar and then select **Curve settings** from the button menu. In this case, the settings will be applied by default when a new curve is built.
2. Right-click on the curve or a point on the curve and select **Tool options** from the menu that pops up. The settings are only applied to the current curve.

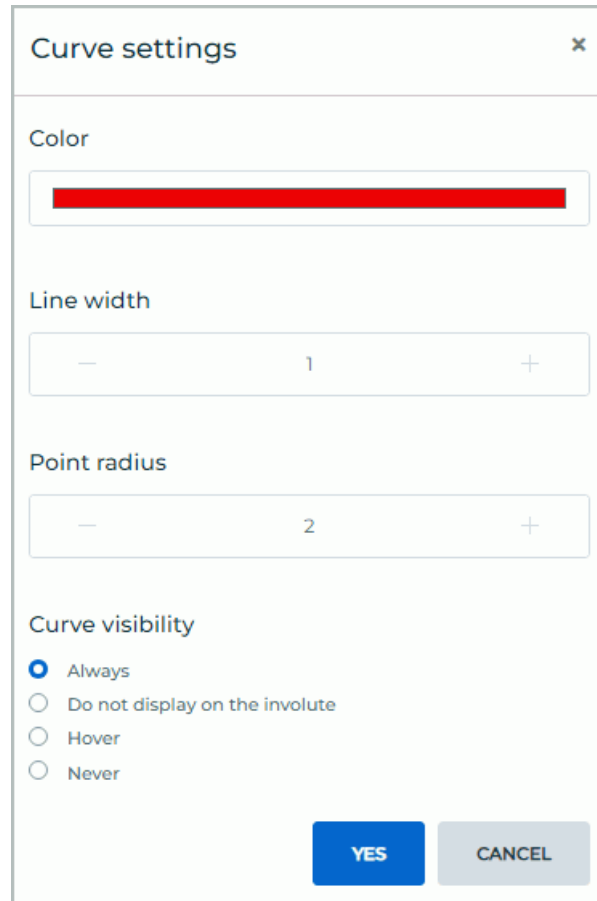

Figure 6.6: Curve options dialog box

In the **Curve settings** dialog box (Fig. 6.6) you can set up the following parameters:

- **color**;
- **line width** in pixels;
- **point radius** in pixels.

For more details on configuring rendering parameters, see Section 4.6.7.

Set the curve visibility mode:

- **Always**. The curve is constantly displayed in all the plane projection windows and in the involute window. This mode is set by default;
- **Don't show on the involute**. The curve is constantly displayed in all the plane projection windows, except for the involute window;
- **Hover**. The curve is displayed in all the plane projection windows and in the involute window if the mouse cursor is placed over it;
- **Never**. When the curve is being built, it is displayed in all the plane projection windows and in the involute window. The curve is not displayed after it has been built. The

visibility mode of a hidden curve cannot be changed. To build a new curve, close the involute window and adjust the curve visibility mode settings.

To apply the settings, click **YES**. To cancel, click **CANCEL**.

6.4.2 Actions with a Curve

A curve can be edited with the left, right, or middle mouse button (see Section 4.6.8).

To make it easier to find a point on the curve on all the projections, locate the cursor on this point. The point will be magnified on all the projections. Points on the curve can be edited in all the cutting plane windows. Editing curve points in the **MPR - Curved surface** window unavailable.

The following actions are available:

- **drag a point.** Locate the cursor on the point so that it enlarges, and drag the point holding down the left mouse button . Then release the mouse button;
- **add a point.** Locate the cursor on the curve where the point should be added. Right-click the mouse and select the **Add point** item;
- **delete a point.** Locate the cursor on the point. Right-click the mouse and select the **Delete point** item. When the penultimate point is deleted, the curve is deleted;
- **continue a curve.** Locate the cursor on one of the border points of the curve. Right-click the mouse and select the **Continue curve** item. Then, perform Steps 5-7 of the curve building algorithm.
- **delete a curve.** Mouse over the curve or a point on the curve. Right-click the mouse and select **Delete** item.

6.5 Measurements

The measurements in the windows of the projections of cutting planes are conducted in the same way as for flat images (see Section 4.6).

The following tools cannot be used in the **MPR - Curved surface** window:

- **Curvilinear reconstruction mode;**
- **Reopen the series;**
- **Rotation;**
- **Flip Horizontally/Vertically;**
- **Magnifier;**
- measurement tools (**Distance measurement ruler, Distance measurement polyline, Angle measurement, Kobb angle**);
- **Synk by point;**
- **Export;**

- **Open tags;**
- **Calibration.**

For **ROI ellipse**, **ROI rectangle** and **ROI polygon** tools, the area and perimeter values are not displayed in the **MPR - Curved surface** window.

6.6 Annotations

Annotations are described in Section [4.7](#).

6.7 Calibration

The procedure of image size calibration in the MPR reconstruction mode is similar to the procedure of image size calibration in the flat image viewer mode, except that you can only calibrate all the images of the series. The procedure of image size calibration is described in Section [4.9](#).

Chapter 7

ECG Viewer

7.1 View Graphs

If the graphs do not fit on the screen, then:

- pan them horizontally with the mouse, holding the left button;
- pan them vertically by rolling the mouse wheel.

7.2 Toolbar

The toolbar is at the top of the tab (Fig. 7.1).



Figure 7.1: Toolbar

7.2.1 ECG Speed

Two speed values are available: 25 and 50 millimeters per second. The default speed is 50 millimeters per second. The required value can be set using the **ECG horizontal scale**

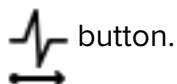

button.

7.2.2 Scale

Two scale values are available: 10 and 20 millimeters per millivolt. The default scale is 10 millimeters per millivolt. The required value can be set using the **ECG vertical scale**



button.

7.2.3 Length Interval

To select a length interval:

1. Activate the **Measuring time intervals**  tool on the toolbar with the left/right/middle mouse button. To continue work with this tool, use the button with which the tool was activated. To learn more about tool control, see Section 3.9.
2. Move the mouse along the graph to find the point to start with (it does not matter if the point is located on the left or on the right).
3. Click the mouse button to fix the point.
4. Move the mouse along the graph to locate the second point. The interval length value will be displayed against the interval background.
5. Click the mouse button to fix the point.

To change the length of an interval, hover the mouse over its boundary and, while holding the mouse button down, move the boundary.

To move the interval, locate the cursor on it and drag it holding the left mouse button.

Only one interval can be built at a time.

To hide the interval, deactivate the **Measuring time intervals** tool.

7.2.4 Value Interval

To select a value interval:

1. Activate the **Measuring voltage level**  tool on the toolbar with the left/right/middle mouse button. To continue work with this tool, use the button with which the tool was activated. To learn more about tool control, see Section 3.9.
2. Move the mouse over the graph to locate the point to start with (it does not matter if the point is located at the top or at the bottom).
3. Click the mouse button to fix the point.
4. Move the mouse over the graph to locate the second point. The value matching the interval will be displayed against the interval background.
5. Click the mouse button to fix the point.

To change the height of an interval, hover the mouse over its boundary and, while holding the mouse button down, move the boundary.

To move the interval, locate the cursor on it and drag it, holding the mouse button.

Only one interval can be built at a time.

To hide the interval, deactivate the **Measuring voltage level** tool.

7.2.5 Set Up Coordinate Plane



To change the color scheme, click the **CLUTs**  button on the toolbar and in the **CLUTs** dialog box select a color scheme. Two color scheme options are available: **classic** (set by default) and **green**.

7.3 Frequency Filters

If an ECG is recorded with distortions, use filters to correct the graphs.



Graphs are changed when filters are applied. To establish a diagnosis, you need to use the original data.

These filters remove the components whose frequency is higher than 35 Hz (the **Low pass filter 35 Hz**  button) or 75 Hz (the **Low pass filter 75 Hz**  button). To apply the filter, click the corresponding button. To cancel filtering, click the corresponding button again. Only one filter can be applied at a time.

To remove power line interference from the ECG signal, use the Notch filter. To apply the filter, click the **Notch filter 50 Hz**  button. The tool has current value 50 Hz. If you need to set a different value, click on the arrow on the right side of the **Notch filter 50 Hz** button and select the **Custom notch filter** item. In the **Render params** dialog box set the value of the frequency in your power supply. To apply the settings, click **YES**. To cancel the settings, click **CANCEL**.

To cancel filtering, click the button again.

To remove the walks of the baseline of the graph, use a High pass filter. To apply the filter, click the **High pass filter**  button. To cancel filtering, click the button again.

7.4 Export series

To export, click the **Export**  button. When exported, the series is saved as the current image in the active window. The series is saved to the user's storage in the current study as a new series or to a specified directory as a file with *.png* or *.jpg* extension. In web browsers other than Chrome, export to a file with *.bmp* extension is possible. Detailed information on configuring series export is provided in Section 4.19.

Chapter 8

Creating Links for Viewing Studies

In the Web DICOM Viewer, the function of creating links for viewing studies has been added. The created study links can be used for:

- providing study data to the patient. The patient can view their study or provide the study link to a specialist;
- sharing study data with other healthcare professionals for the purpose of consultation;
- linking the study to other patient data in medical systems, for example, for linking the patient's study to their medical record.

Links to studies can be created by the user from the main page of the Web DICOM Viewer, from the list of studies, and from the study viewer tab.

The server address (Url) in the link is the value of the *serverUrl* parameter in the **.config.json** configuration file and can be modified by the administrator. The detailed information is available in the **Links** section of the Admin's Manual.

8.1 Creating a Link from the Study List

To create a link to a study from the study list, follow these steps:

1. On the studies panel, select the study for which you need to create a link.
2. Select the study series that will be opened first when the link is used. By default, the first series of the study is selected.
3. Click the arrow on the right-hand side of the **Create link**  button on the toolbar. On the dropdown menu, select the **Customise link** option.

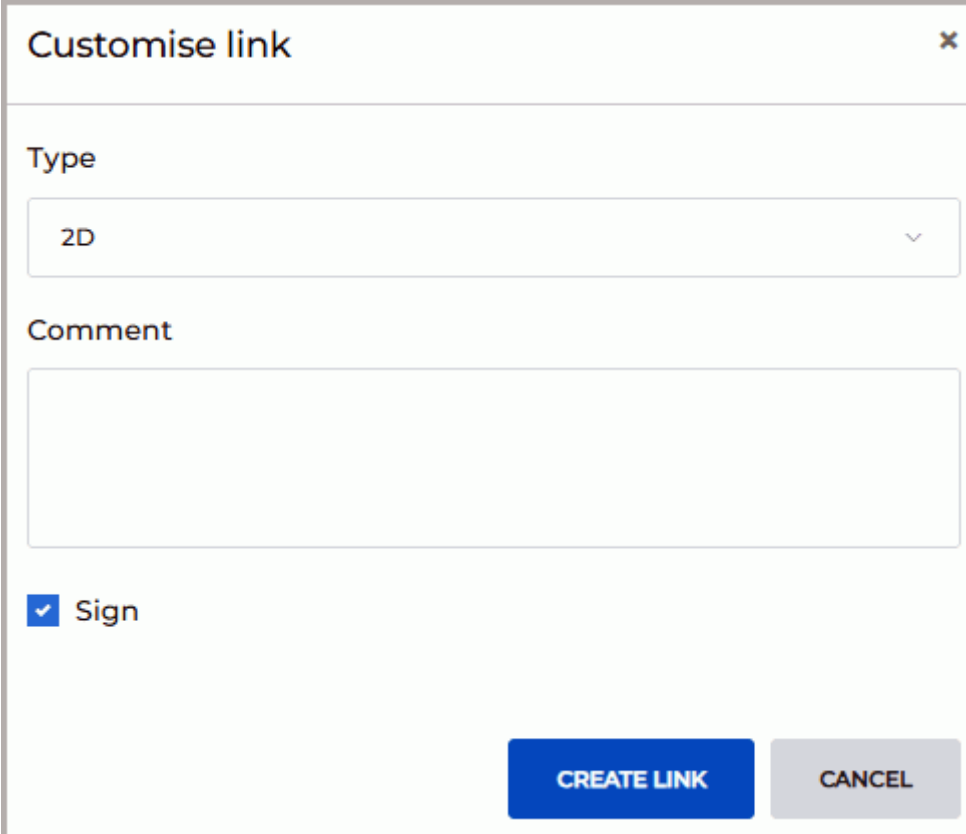

The image shows a dialog box titled "Customise link" with a close button in the top right corner. Inside the dialog, there is a "Type" dropdown menu currently set to "2D". Below that is a "Comment" text area. At the bottom left, there is a checked checkbox labeled "Sign". At the bottom right, there are two buttons: "CREATE LINK" (highlighted in blue) and "CANCEL" (greyed out).

Figure 8.1: Dialog box for configuring and creating a link from the study list

4. In the **Customise link** dialog box (Fig. 8.1), select the viewing mode in which the chosen series will be opened when the link from the **Type** dropdown list is used. The modes available are:
 - **2D** — opens the series in the **Image viewer** window. Set by default;
 - **MPR** — opens the series in the **MPR reconstruction** window;
 - **3D** — opens the series in the **Volume reconstruction** window.
5. If necessary, add a comment to the link.
6. To sign the link, check the **Sign** checkbox. By default, the box is checked. If a license for signing links is not available, the **Sign** checkbox is not displayed and links cannot be signed.

A signed link can be opened regardless of the number of current concurrent sessions. Once the limit for signed links has been reached, signing additional links becomes impossible.

The total number of links that can be signed is displayed on the admin panel on the **Server settings** page. The detailed information on the number of links that can be signed is available in the **Unified User Licenses** section of the Admin's Manual.
7. Click the **CREATE LINK** button to create the link, or **CANCEL** to exit the dialog without creating a link.

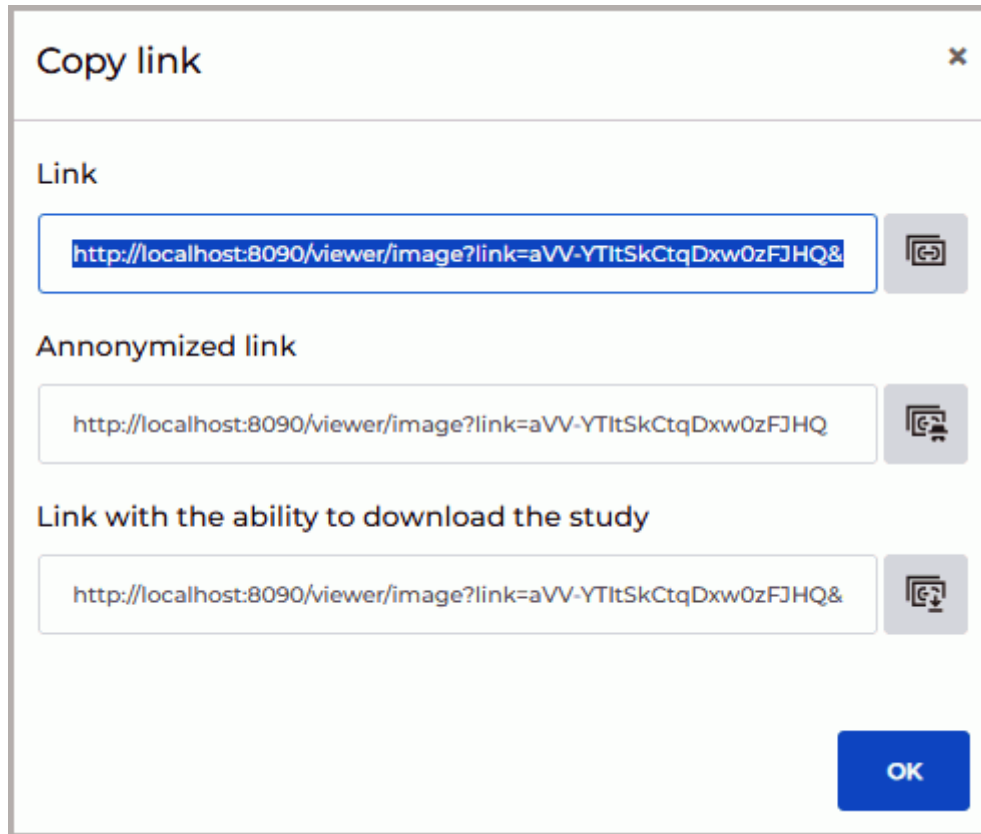





Figure 8.2: Copy link dialog box

8. In the **Copy link** dialog box that pops up (Fig. 8.2), three links to the study are displayed. To copy a study link, click the **Copy link to open the study**  button. The link will be copied to the user's device clipboard.

To hide personal data when the study is viewed via the link, click the **Copy link to open the anonymized study**  button. The link is will be copied to the user's device clipboard. When the study is opened via this link, personal data is not displayed. You cannot view structured reports, protocols, tags, and PDF documents for anonymized studies.

To copy a link that allows the user to open and download the study, click the **Copy link to open and download the study**  button. The link is copied to the user's device clipboard. When the study is opened via this link, the user gains the ability to download the study (see Section 3.4.2).

The created links are also displayed on the **Links** page (see Section 2.6) in the Web DICOM Viewer settings section.

9. To close the **Copy link** dialog box, click **OK** or **X** in the upper right corner of the dialog box.

When the **Create link**  button is clicked, steps 4-7 are skipped, and the **Copy link** dialog box (Fig. 8.2) pops up displaying the links. In this case, the **Sign** checkbox status previously set by the user and the **2D** viewing mode will be applied to the links created.

8.2 Creating a link from the Viewer Tab

To create a link to a study from the viewer tab, follow these steps:

1. On the open viewer tab, select the study series window that will be opened first when the link is used.
2. Click the arrow on the right-hand side of the **Create link**  button on the toolbar. On the dropdown menu, select **Customise link**. The viewing mode used for the selected series when it is opened via the link is automatically set to match the mode in which the series was opened for link creation. If the series is open in several modes within the same tab at the same time, the viewing mode type will match the mode of the window that was active at the time the link creation.

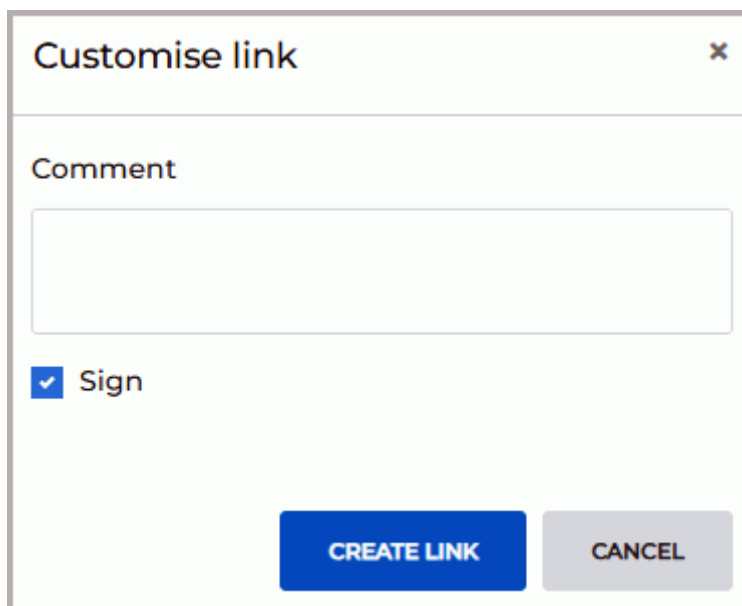



Figure 8.3: Dialog box for customizing and creating a link from the viewer tab

3. In the **Customise link** dialog box (Fig. 8.3), add a comment if necessary. To sign the link, check the **Sign** checkbox. By default, the checkbox is checked. If a license for signing links is not available, the **Sign** checkbox is not displayed and links cannot be signed.

Signed links can be opened regardless of the number of current concurrent sessions. Once the limit for signed links has been reached, signing additional links becomes impossible.

The total number of links that can be signed is displayed on the admin panel on the **Server settings** page.

4. Click the **CREATE LINK** button to generate the link, or **CANCEL** to exit the dialog box without creating a link.
5. In the **Copy link** dialog box that pops up (Fig. 8.2), three links to the study are displayed.

To copy a study link, click the **Copy link to open the study**  button. The link will be copied to the user's device clipboard.

To hide personal data when the study is viewed via the link, click the **Copy link to open the anonymized study**  button. The link will be copied to the user's device clipboard. When the study is opened via this link, personal data is not displayed. You cannot view structured reports, protocols, tags, and PDF documents for anonymized studies.

To copy a link that allows the user to open and download the study, click the **Copy link to open and download the study**  button. The link is copied to the user's device clipboard. When the study is opened via this link, the user gains the ability to download it (see Section 3.4.2).

The created links are also displayed on the **Links** page (see Section 2.6) in the Web DICOM Viewer settings section.
6. To close the **Copy link** dialog box, click **OK** or **X** in the top right corner of the dialog box.

When the **Create link**  button is clicked, the **Copy link** dialog box (Fig. 8.2) pops up displaying the links. In this case, the **Sign** checkbox status previously set by the user will be applied to the links created. The viewing mode type is set to match the mode of the active viewer window.

8.3 Restrictions on Viewing Studies via Links

When a study is being viewed via a link, some features of the Web DICOM Viewer may be unavailable.

The following tools are unavailable when the user is viewing a study via a link:

- **Create link;**
- **Customise link;**
- **Quick image export;**
- **Image export;**
- **Open editor.**

When a study is opened via an anonymized link, the patient's personal data is not displayed. Structured reports, protocols, tags, and PDF documents cannot be viewed for anonymized studies.

The user can only download studies via links that provide such an opportunity.

The tool settings modified by the user viewing a study that was opened via a link will be applied till the end of the session. After closing the tab, the tool settings will be reset to their default values.

When a tab with a study opened via a link is closed, the tab closure confirmation dialog is not displayed, regardless of the settings on the **General** page.

Chapter 9

Report Editor

In the Web DICOM Viewer report editor, users can create, edit, and save medical documents, such as logs, assessments, reports, etc.

The Web DICOM Viewer report editor supports such functions as text formatting, table creation and editing, as well as inserting images from the clipboard.

Reports created by users are stored as special SR series in the user's storage and can be exported as series containing PDF files.

9.1 Editor Window

The editor window is shown in Fig. 9.1. The windows and text editing tools are identical for the report editor and the template editor.

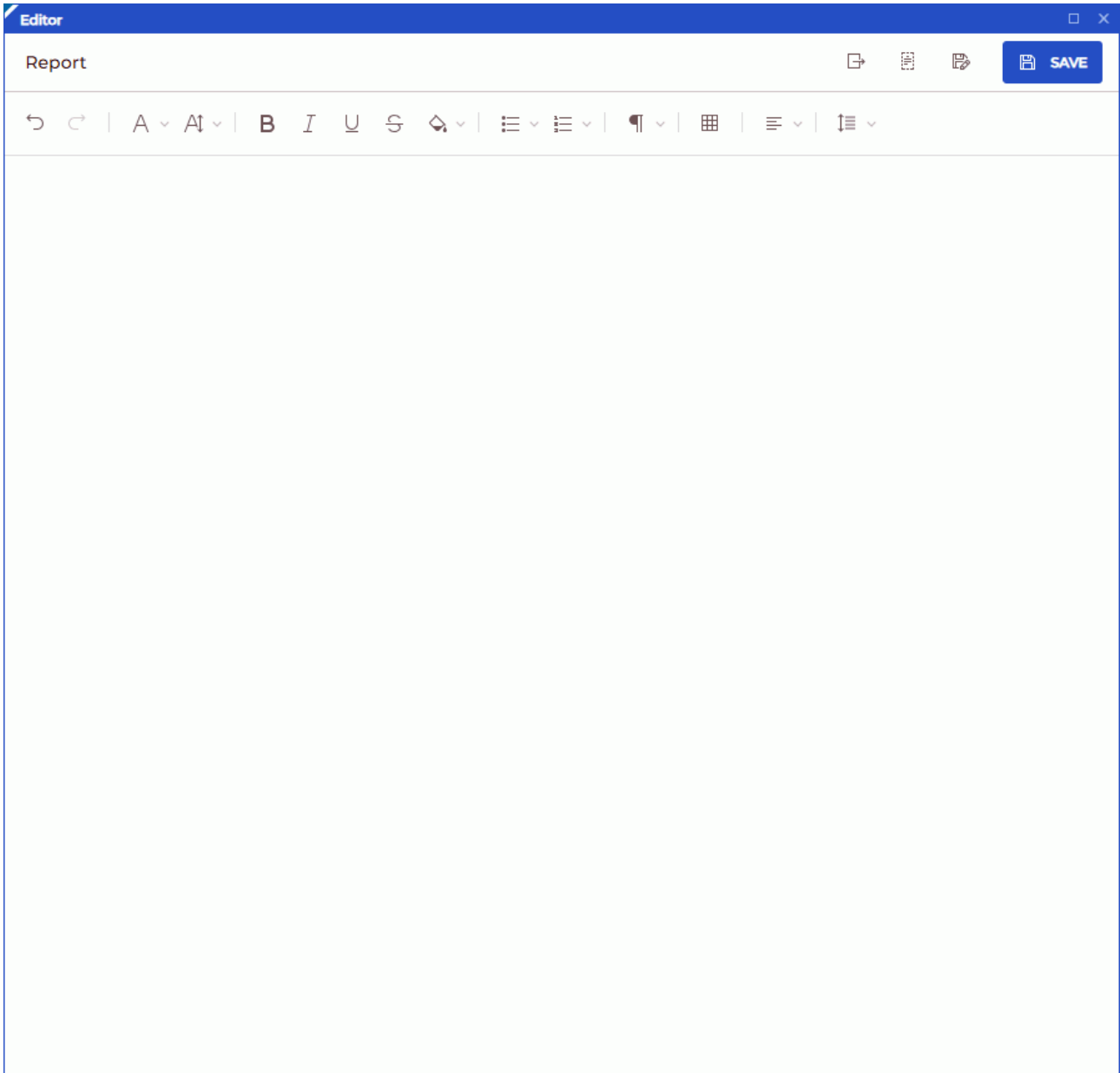







Figure 9.1: Editor window

9.1.1 Toolbar

The toolbar is located at the top of the editor window (Fig. 9.1).





In the upper left corner of the toolbar, there is a field where the user enters the document name.



At the top of the editor window, the following buttons are located:

| | |
|-------------------------------------------------------------------------------------|-----------------------------------------------------------------------------------------------------------------------------------------------------------------------------------------------------------------------------------------------------------------------------------------------------------------------------------------------------|
|  | The Export button exports the report to the current study as a new series containing a PDF file (see Section 9.2.3). |
|  | The Save as template button saves the report as a template (see Section 9.3.2). |
|  | The Save as button in the report editor window provides an opportunity to save the report under a new name and continue work with the new report (see Section 9.2.2). In the template editor window, the button provides an opportunity to save the template with a new name and continue work with the new template (see Section 9.3.4). |
|  | The SAVE button in the report editor window saves the report to the current study as a new SR series. Subsequent clicks on the button save changes to the current report (see Section 9.2.2). In the template editor window, the button saves changes to the current template (see Section 9.3.4). |
|  | The Undo button cancels the last change made in the report/template editor. |
|  | The Redo button repeats the last undone action in the report/template editor. |





9.1.2 Text Editing Tools

The editor toolbar contains text editing tools. The text editing tools in the report editor and template editor have similar functions.

- the **Font family**  button shows a dropdown list of the available font families;
- the **Font size**  button shows a dropdown list with the most popular font sizes. Font sizes are specified in typographic points;
- buttons for visual modification of the characters and text style:
 - **Bold**  ;
 - **Italic**  ;

- **Underline** ;
- **Strikethrough** .

Style changes are applied to the selected or entered text.

- the **Highlight color/Font color**  button changes the background or text color. The changes are applied to the selected character or text fragment;
- the **Bulleted list**  button creates a bulleted list. The following bullet types are available:
 - **Bulleted list (a filled circle);**
 - **Bulleted list (an empty circle);**
 - **Bulleted list (a filled square).**
- the **Ordered list**  button creates a numbered list. The following styles are available:
 - **Ordered list(numbers);**
 - **Ordered list (lower romans);**
 - **Ordered list (upper romans);**
 - **Ordered list (lower letters);**
 - **Ordered list (upper letters).**
- the **Heading**  button calls up the dropdown list of preset font styles, including:
 - **Default;**
 - **Heading 1;**
 - **Heading 2;**
 - **Heading 3;**
 - **Heading 4;**
 - **Heading 5;**
 - **Heading 6.**
- the **Insert table**  button is used to insert tables into the document. When the user clicks the button, a grid for creating tables is displayed, where the desired number of columns and rows can be selected by moving the cursor over the grid. To create a table, click the left mouse button.

If the cursor is placed at the beginning of a line, the table is inserted into that same line. If the text cursor is placed elsewhere, the table is inserted into the next line. By default, all the table columns have equal width. To adjust the width of a column, drag one of its borders left or right. The row height is adjusted automatically in compliance with the cell contents.

Table cell formatting commands are accessed from a pop-up menu (Fig. 9.2), which is displayed near the selected cell.

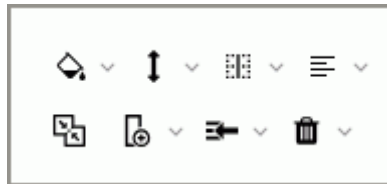

















Figure 9.2: Pop-up menu for table editing

The following actions are permitted:

- **Changing the background, text, and border color.** Select the cells for which you want to change the background, text, or border color. Click the arrow on the right-hand side of the **Background**  button and choose the background, text, and border color;
- **Vertical alignment of objects in a cell.** Select a cell or range of cells where the objects need aligning. Click the arrow on the right-hand side of the **Vertical align**  button and select the desired alignment option;
- **Splitting cells.** Select a cell or range of cells to be splitted. Click the arrow on the right-hand side of the **Split cells**  button and choose a splitting option;
- **Aligning text in cells.** Select a cell or range of cells where the text needs aligning. Click the arrow on the right-hand side of the **Align**  button and select the desired alignment option; item **Merging cells.** Select a range of cells to be merged. To merge the selected cells, click the **Merge cells**  button;
- **Inserting columns.** Select a cell next to which you want to insert a column. Click the arrow on the right-hand side of the **Insert column**  button and choose **Insert column to the left** or **Insert column to the right** from the dropdown menu;
- **Inserting rows.** Select a cell next to which you want to insert a row. Click the arrow on the right-hand side of the **Insert row**  button and choose **Insert row above** or **Insert row below** from the dropdown menu;

- **Deleting cell contents.** Select the cells whose contents you want to delete. Click the arrow on the right-hand side of the **Delete**  button and select **Empty cells** from the dropdown menu;
 - **Deleting rows.** Select a cell in the row to be deleted or select several rows. Click the arrow on the right-hand side of the **Delete**  button and select **Remove rows** from the dropdown menu;
 - **Deleting columns.** Select a cell in the column to be deleted or select several columns. Click the arrow on the right-hand side of the **Delete**  button and select **Remove columns** from the dropdown menu;
 - **Deleting the table.** Select any cell in the table. Click the arrow on the right-hand side of the **Delete**  button and select **Remove table** from the dropdown menu.
- the **Align** button is used to align the text in the selected paragraph. The following options are available:
 - **Centre align**  ;
 - **Left align**  (set by default);
 - **Right align**  ;
 - **Justify**  .
 - the **Line height**  button is used to set the spacing between lines.

9.2 Actions with the Reports

9.2.1 Creating an Empty Report



To create a new report from the study list tab, select a study on the studies panel. Click the **Open editor**  button on the toolbar.

To create a new report from the series viewer tab, click the **Open editor**  button on the toolbar.

If a non-empty default template is set for creating reports, click the arrow on the right-hand side of the **Open editor**  button on the toolbar and select **Empty** from the menu to create a new empty report. For details see Section [9.2.5](#).

You will find the information on creating reports on the basis of templates in Section 9.2.5.

9.2.2 Saving a Report

To save a report, click the **SAVE**  button on the editor toolbar. The report will be saved to the current study as a special type series with **SR** modality. The name of the report will be displayed as the series name and description. If the **SAVE**  button is clicked again, changes will be saved to the current SR series. In Fig. 9.3, you can see the thumbnail of a series containing a report.

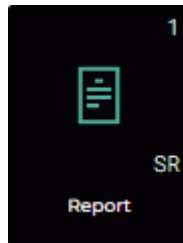



Figure 9.3: Thumbnail of a series containing a report

To save the report with a new name, click the **Save as**  button on the editor toolbar. In the dialog box that pops up, enter the new report name. By default, the dialog displays the current report name or a modified version of this name if it matches an existing saved name. In case of name conflicts, a numeric value in parentheses is added to the name.

9.2.3 Exporting a Report

The Web DICOM Viewer provides an opportunity to export a report to the current study as a new series containing a PDF file.

To export a report in its current state, click the **Export**  button on the toolbar. The name of the report is used as the default name of the PDF series.

9.2.4 Viewing and Editing a Report

Attention! If a study or a series containing a report is located on a PACS server, then to view the report, you have to download the selected series or the study containing the selected series to the user's storage.

There are several ways to open a previously created report for viewing and editing:

1. Double-click with the left mouse button on the SR-series thumbnail on the series panel.
2. Select the SR series thumbnail and click the **Image viewer**  button on the toolbar.

3. Right-click the SR series thumbnail to open the context menu and select **Open editor**.

The report contents and name can be edited. Save the edited report (for more details see Section 9.2.2).

9.2.5 Creating a Report on the Basis of a Template

To create a report on the basis of a template, click the arrow on the right-hand side of the **Open editor**  button on the toolbar. On the dropdown menu (Fig. 9.4), select the desired template from the list by clicking its name. The report editor window will be opened in accordance with the selected template.

To choose a template that will be used by default for creating reports, activate the toggle switch next to the selected template. By pressing the left-hand side of the **Open editor**  button, reports will be created on the basis of the template selected as the default.

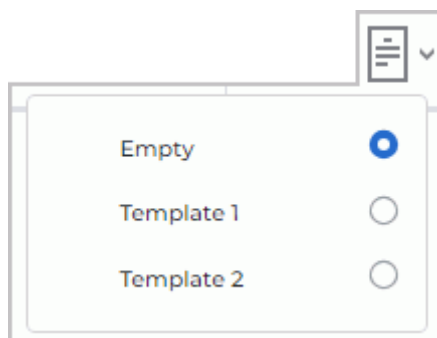

Figure 9.4: Example of a template list from the **Open editor** button menu

For detailed information on templates (their creation, editing, and deletion), see Section 9.3.

9.3 Report Template

The Web DICOM Viewer allows for the creation of report templates that simplify the process of filling out reports for users.

Users can edit and delete only the report templates that they have created themselves. General report templates created by the administrator cannot be edited or deleted by users.

Detailed information on creating general report templates is provided in Section 3.10 **Report templates** of the Admin's Manual.

9.3.1 Creating an Empty Template

To create a new report template, click the arrow on the right-hand side of the **Open editor**  button on the toolbar. On the dropdown menu (Fig. 9.5), select the **Create** option.

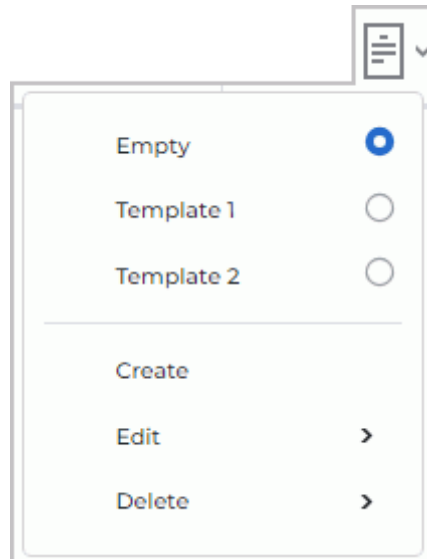



Figure 9.5: Dropdown menu of the **Open editor** button

By default, an empty report template named **Nameless** is created. The template editor window is identical to the report editor window.

Attention! If no templates have been created yet, the Empty option for creating an empty template will not appear on the menu of the Open editor button.

9.3.2 Creating a Template in the Report Editor Window

To create a template in the report editor window, follow these steps:

1. Open an existing report in the report editor or create a new one.
2. Rename the report by entering a unique name in the input field.
3. Click the **Save as template**  button on the editor toolbar. In the confirmation dialog, click **YES** to switch to the template editor mode, or **CANCEL** to cancel.

Attention! Clicking the Save as template button will result in the loss of any unsaved changes in the report.

4. The report editor mode will be switched to the template editor mode. The saved template will be added to the template list on the **Open editor**  button menu.
5. If required, edit and save the report template as described in Sections 9.3.3 and 9.3.4.



9.3.3 Viewing and Editing the Report Template

To edit a report template, click the arrow on the right-hand side of the **Open editor**  button on the toolbar. On the dropdown menu for the button (Fig. 9.5), select the **Edit** option

and choose the template name. Edit the name and the content of the template. Save the edited report template.

Users can edit only the report templates they have created themselves. General report templates created by the administrator are not displayed on the Edit option list.

9.3.4 Saving a Report Template

To save a report template, click the **SAVE**  button on the editor toolbar. The saved template is added to the template list of the **Open editor**  button menu. Subsequent clicks on the **SAVE**  button will save changes to the current template.

To save a template with a new name, click the **Save as**  button on the editor toolbar. In the dialog box that pops up, enter the new template name. From that moment on, you will be working with the newly saved template, not the original one.

The new report template will be added to the template list of the **Open editor**  button.

9.3.5 Deleting a Report Template

To delete a report template, click the arrow on the right-hand side of the **Open editor**  button on the toolbar. On the dropdown menu for the button (Fig. 9.5), select the **Delete** option and choose the template from the list. In the confirmation dialog, click **YES** to delete the report template, or **CANCEL** to abort.

Users can delete only the report templates they have created themselves. General report templates created by the administrator are not displayed on the Delete option list.

Chapter 10

Licensing

Information about the current operating mode of the Web DICOM Viewer is displayed in the **Licensing type** field on the **Server settings** page of the administrator's panel. Detailed information about the licensing types and license activation is provided in Section **3.3 Licensing. License activation** of the Admin's Manual.

10.1 Personal User Licenses

The license key activated for a certain user creates one personalized connection providing for continuous access to the system. The user with a personal license has constant access to the system.

10.2 Concurrent licenses

A concurrent license is a license limiting the number of users who can work in the system simultaneously.

The Web DICOM Viewer server automatically provides an unoccupied connection to the user when he/she logs in. The connection provided belongs to the shared unoccupied connection pool. The shared connection pool is a list of unoccupied concurrent connections. The connection stays active during the work session, which ends after the user logs out.

When a study is opened via a link, concurrent user connections are used.

Attention! If there are not enough concurrent connections, the user will be able to work in the system only after another user log out and an unoccupied connection appears.

10.3 Unified User Licensing

Unified licensing combines the capabilities of personal and concurrent licensing types with a number of additional features.

Thanks for selecting our product! The Inobitec Software FZ-LLC team is constantly working to improve it. We will be grateful for any feedback, comments and suggestions how to enhance the product functionality, user-friendliness and visualization quality.

We wish you success in your work!