

Inobitec DICOM Viewer version 2.15

# USER'S MANUAL

Editions **LITE** and **PRO**

VOLUME GRAPHS FOR  
FUNCTIONAL ANALYSIS  
OF THE HEART

DOWNLOADING SERIES AND STUDIES BY WADO

AUTO CONSTRUCTION OF THE LV'S OUTER BORDER



---

The information contained in this User Manual belongs to the Inobitec Software FZ-LLC, Dubai Media City, Building 05, Dubai, UAE, P.O. Box 73030. The Manual is delivered to the users of Inobitec DICOM Viewer software product exclusively for the purpose of working with this product. No part of the information contained herein can be modified, used for any other purpose or delivered to any third party without the prior written consent of the Inobitec Software FZ-LLC. The Inobitec Software FZ-LLC reserves the right to alter this Manual without prior notice. Screenshots are made in Windows for the Dark style of the Viewer. Certain visual differences between the Viewer interface and the images in the screenshots are allowable.

# Contents

<b>Contents</b>	<b>3</b>
<b>About this Manual</b>	<b>16</b>
Accepted Conventions . . . . .	16
Warnings . . . . .	16
<b>Technical Support</b>	<b>17</b>
<b>About the Product</b>	<b>18</b>
DICOM Viewer Functionality . . . . .	19
New Functions in Version 2.15 . . . . .	29
<b>Installing, Uninstalling and Launching the Program</b>	<b>30</b>
System Requirements . . . . .	30
Installing, Uninstalling and Running the Program on Windows . . . . .	32
Installing the Program using the Installer . . . . .	32
Silent program Installation . . . . .	40
Uninstalling the Program using an Uninstaller . . . . .	41
Silent Uninstallation the Program . . . . .	43
Running the Program . . . . .	43
Installing, Uninstalling and Running the Program on Mac OS . . . . .	44
Installing the Program . . . . .	44
Uninstalling the Program . . . . .	44
Running the Program . . . . .	44
Installing, Uninstalling and Running the Program on Linux . . . . .	44
Running the program in ApplImage Format . . . . .	44
Uninstalling the Program . . . . .	45
Launch multiple instances of the program . . . . .	46
Service files . . . . .	46
Getting Started . . . . .	47
First run of the Program . . . . .	47
Launching the Web Viewer . . . . .	52
<b>1 Program Window Elements</b>	<b>53</b>
1.1 Main Menu . . . . .	54
1.1.1 File . . . . .	54
1.1.2 Network . . . . .	55

1.1.3	Storage	55
1.1.4	View	55
1.1.5	Studies	56
1.1.6	Series	57
1.1.7	Options	57
1.1.8	Help	57
1.2	Window Management	58
1.3	Tab Panel	58
1.3.1	General	58
1.3.2	Manage a Tab	59
1.4	Toolbar	61
1.5	Select Data Source	64
1.5.1	Select a CD, DVD or Local Folder as the Data Source	64
1.5.2	Opening Zipped DICOM Studies	65
1.5.3	Opening DICOM studies by dragging and dropping	65
1.5.4	Opening DICOM studies from the context menu	66
1.5.5	Select a PACS Server or Local Storage as the Data Source	67
1.6	Save Studies and Series to the folder	68
1.6.1	Save Studies to the folder	68
1.6.2	Save Series to the folder	69
1.7	Search Panel	70
1.7.1	Saving the Search Parameters	71
1.7.2	Searching for Studies by Preset Parameters	72
1.8	Select Server Panel	73
1.9	Study Panel	73
1.9.1	Customize Study Panel	74
1.9.2	Sort Studies	74
1.9.3	Edit Patient Name and Description in a Study	75
1.9.4	Study List Export	77
1.10	Series Panel	78
1.11	Studies and Series Download/Upload Panels	78
1.12	Information Panel	80
1.13	Uncompress series	80
1.14	Tool Control Buttons	81
<b>2</b>	<b>View Flat Images</b>	<b>82</b>
2.1	Open Series	82
2.2	Open Series with Current Settings	84
2.3	Context Menu of the Image Viewer Tab	84
2.4	Working with Several Monitors and Split Screen	86
2.5	Resampling filter	88
2.6	Image Filters	89
2.6.1	Preset Filters	89
2.6.2	User Filters	90
2.6.3	Actions with Filters	91
2.7	View Images in a Series	92
2.8	Switch between Series	93
2.9	View Several Studies at a Time	93

2.10	View Multiple Series	95
2.10.1	Auto Mode	97
2.10.2	Stacked Mode	97
2.10.3	Grid Mode	98
2.10.4	Custom Mode	98
2.11	View Multiple Images in the Same Series Simultaneously	100
2.12	Viewing Several Series as a Single Multiphase Series	102
2.13	Viewing Orthogonal Projections of Images	103
2.14	Play images	104
2.15	Video recording	105
2.16	Zoom. Pan. Rotate	107
2.16.1	Zoom	107
2.16.2	Pan	108
2.16.3	Rotate	108
2.17	Set Window Level and Width	108
2.17.1	User Presets for Window Width and Level	111
2.17.2	Actions with presets	112
2.17.3	Additional Width and Level Settings	113
2.17.4	Setting the Window Width and Level for Merged Series	114
2.18	Magnifier	115
2.19	Measurements	115
2.19.1	Ruler	116
2.19.2	Displaying angles between intersecting rulers	117
2.19.3	Polygonal Ruler	117
2.19.4	Angle	118
2.19.5	Cobb angle meter	119
2.19.6	Measure Intensity at a Point	120
2.19.7	Measure the Intensity Average and Standard Deviation in an Area	121
2.19.8	Measuring the Cardiothoracic Ratio (CTR)	122
2.19.9	Drawing Parameters	123
2.19.10	Move Measurements	124
2.19.11	Move Measurement Results	124
2.19.12	Delete Measurements	124
2.19.13	Measuring Dimensions and Area during Ultrasound Imaging	125
2.19.14	Measuring the Time Interval and the Blood Flow Velocity during Ultrasound Imaging	125
2.20	Perfusion Parameters Estimation	126
2.20.1	Open series in Perfusion Parameters Estimation mode	126
2.20.2	Setting the Time Interval on the Perfusion Panel	127
2.20.3	Brain Perfusion Parameters Estimation	129
2.20.4	Map mode	133
2.20.5	Advanced Settings for Bayesian Estimation Algorithm	136
2.20.6	Deconvolution Advanced Settings	140
2.21	Evaluation of Blood Flow Parameters	141
2.21.1	Opening a Series in the Blood Flow Parameters Evaluation Mode	142
2.21.2	Changing the Configuration Parameters for a PC MRI Series	146
2.21.3	Building and Editing Vessels ROI	146

2.21.4	Blood Flow Analysis Panel. Displaying the Results of General Blood Flow Analysis . . . . .	148
2.21.5	Evaluating the General Blood Flow Analysis Parameters . . . . .	151
2.21.6	Designing a Trajectory for the Pulse Wave . . . . .	153
2.21.7	Getting the Results of Advanced Blood Flow Analysis without Building a Pulse Wave Trajectory . . . . .	156
2.21.8	Blood Flow Analysis Panel. Displaying the Results of Advanced Blood Flow Analysis . . . . .	157
2.21.9	Evaluation of the Parameters for Advanced Blood Flow Analysis . . . . .	159
2.21.10	Blood Flow Parameters Evaluation for Two Slices . . . . .	160
2.22	Visualize Images . . . . .	164
2.22.1	Select CLUT . . . . .	164
2.22.2	Edit CLUTs List . . . . .	165
2.22.3	CLUT Parameters . . . . .	167
2.22.4	Create and Edit CLUT . . . . .	170
2.22.5	User CLUTs Import . . . . .	172
2.23	SUV Measurement . . . . .	172
2.24	Calcium Scoring . . . . .	175
2.24.1	Selection of measurement areas . . . . .	175
2.24.2	Actions with measurement areas . . . . .	177
2.24.3	Measurement results . . . . .	178
2.25	Scout Lines . . . . .	180
2.25.1	The Tool Menu . . . . .	181
2.25.2	Line Settings . . . . .	181
2.26	Set Up Viewer Workspace . . . . .	182
2.27	Export Images . . . . .	184
2.27.1	Export to DICOM . . . . .	184
2.27.2	Export to Image . . . . .	186
2.28	DSA Mode . . . . .	188
2.28.1	Single-image subtraction view . . . . .	188
2.28.2	Series subtraction view . . . . .	190
2.28.3	Viewing Several Series of the Same Study Fused in One Multiphase Series with Subtraction . . . . .	190
2.29	Image Information in the Series Window . . . . .	191
2.29.1	Orientation Cube . . . . .	191
2.29.2	Scale . . . . .	191
2.29.3	Image Information . . . . .	191
2.29.4	Patient Information . . . . .	192
2.30	View DICOM Tags . . . . .	192
2.31	Viewing Structured Reports . . . . .	192
2.32	Graphic Label Tool . . . . .	194
2.32.1	General . . . . .	194
2.32.2	Create Labels . . . . .	195
2.32.3	Actions with Labels . . . . .	197
2.33	Synchronize Images . . . . .	198
2.34	Synchronization by a Point . . . . .	200
2.35	Mirror Image Horizontally/Vertically . . . . .	200
2.36	Calibration sizes . . . . .	200

2.37	Apparent diffusion coefficient . . . . .	202
<b>3</b>	<b>Volume Reconstruction</b>	<b>203</b>
3.1	View Images . . . . .	203
3.2	Model Projection . . . . .	204
3.3	Actions with Model . . . . .	205
3.4	Model Positioning Tools . . . . .	206
3.4.1	Model Shift . . . . .	206
3.4.2	Model Rotation . . . . .	207
3.4.3	Model Scaling . . . . .	207
3.5	«Select Model Point» Tool . . . . .	207
3.6	The Play Tool . . . . .	207
3.7	Video recording . . . . .	208
3.8	Cutting Tools . . . . .	209
3.8.1	Polygon Cut . . . . .	209
3.8.2	Inverse Polygon Cut . . . . .	209
3.8.3	Cut object . . . . .	209
3.8.4	Cut all except object . . . . .	210
3.8.5	Cutting Tools Parameters . . . . .	210
3.8.6	Sphere Cut, Sphere Restore and Restore by Mask Tools . . . . .	210
3.8.7	Tools for intelligent volume editing . . . . .	212
3.8.8	Remove Table . . . . .	213
3.9	Center . . . . .	213
3.10	Clipping Box . . . . .	214
3.11	Measurements . . . . .	215
3.11.1	Ruler . . . . .	215
3.11.2	Polygonal Ruler . . . . .	216
3.11.3	Surface ruler . . . . .	217
3.11.4	3D Angle . . . . .	220
3.11.5	Customizing the Text Size for Measuring Tools . . . . .	220
3.12	Markers . . . . .	221
3.13	Export Model . . . . .	221
3.13.1	Export Rotation to Series . . . . .	221
3.13.2	Export Rotation to Images . . . . .	222
3.14	Render settings . . . . .	222
3.15	Reconstruction by Series with Varying Distances between Slices . . . . .	223
3.16	Subtraction of Volumes for Fused Series . . . . .	224
3.17	Remove Bone Tissue . . . . .	225
3.17.1	Remove Bone Tissue Manually (Interactive) . . . . .	225
3.17.2	Removing Bone Tissue Manually (Automatic) . . . . .	226
3.17.3	Remove Bone Tissue for Fused Series . . . . .	227
<b>4</b>	<b>Series Fusion</b>	<b>230</b>
4.1	Create Series Fusion . . . . .	231
4.2	Merge Series from Different Studies . . . . .	232
4.3	Merge layers . . . . .	233
4.3.1	Locking the Frame of Reference for a Layer . . . . .	235
4.3.2	Merge layers automatically . . . . .	236

4.3.3	Merge layers manually	237
4.3.4	Merge layers by control points	237
4.3.5	Export and Import Matrices of Merge Layers	240
4.4	Image registration	241
4.4.1	Series registration	242
4.4.2	Phases registration	244
4.5	Actions with the fused series	246
4.6	Image stitching mode	247
4.7	Volume Stitching	248
<b>5</b>	<b>Multiplanar Reconstruction (MPR)</b>	<b>251</b>
5.1	Open Study in Multiplanar Reconstruction window	251
5.2	MPR View Elements	252
5.2.1	Customizing the Section Windows Arrangement	253
5.3	Resampling filter	255
5.4	Image Filters	256
5.5	Working with Orthogonal Planes	256
5.5.1	View Modes	256
5.5.2	Working with Planes in 3D Cursor Mode	257
5.5.3	Working with Planes in the Cutting Plane Mode	258
5.6	Series Synchronization in MPR Reconstruction Tabs	258
5.7	Curvilinear Reconstruction	260
5.7.1	Build Surface	260
5.7.2	Choosing a Display Mode for an Involute of a Curve	262
5.7.3	Curve settings	264
5.7.4	Actions with a Curve	265
5.7.5	Position of a Curve, Its Nodes and Surface in Space	266
5.7.6	Curved Reconstructions Cross Sections Mode	266
5.8	Displaying Section Planes on 3D Models	270
5.9	«Render settings» Tool	274
5.10	The Play Tool	274
5.11	Video recording	274
5.12	Markers	275
5.12.1	General	275
5.12.2	Add Markers	275
5.12.3	Add Line Markers	276
5.12.4	Polygonal Marker line	276
5.12.5	Actions with Markers	277
5.12.6	Marker Properties	277
5.12.7	Position of Markers in Space	278
5.13	Reconstruction Modes. Slice Thickness	278
5.13.1	Render Modes	278
5.13.2	Slice Thickness	279
5.14	Rotate Image in the Section Plane	279
5.15	Mirror Image Horizontally/Vertically	280
5.16	Show labels tool	280
5.17	Export Images	281
5.18	Reslice	281



5.19	Measurements	284
5.20	Annotations	284
5.21	Volume Reconstruction window	284
5.22	Diffusion Tensor Imaging (DTI) Mode	285
5.22.1	Open series in DTI Mode	286
5.22.2	Select Visible Fibers	286
5.22.3	Fiber Color	288
5.22.4	Scalar Maps	288
5.22.5	Building a Surface	289
5.22.6	Creating a Voxel Model of Fibers	290
5.22.7	Saving data in a file	291
<b>6</b>	<b>Segmentation</b>	<b>292</b>
6.1	The Segmented Structures Panel	295
6.2	The Mask	299
6.2.1	Creating a new structure and mask	299
6.2.2	Changing the structure mask using CLUTs	300
6.2.3	The Editing mask	301
6.2.4	Set Mask Tool	302
6.3	Creating segmented structure	303
6.3.1	Creating a structure by copying	303
6.3.2	Creating a Structure with a Empty Mask	304
6.4	Actions with structure	304
6.5	Building surface	306
6.6	Copying a Surface	309
6.7	Import and Export	311
6.7.1	Export surface	311
6.7.2	Import surface	313
6.7.3	Export a structure to the current study	315
6.7.4	Export a structure to DICOM RT	316
6.7.5	Importing a Structure from DICOM RT	317
6.8	Changing the structure mask with segmentation tools	318
6.8.1	Tools for automatic segmented structure mask filling	320
6.8.2	Brush restore tool	321
6.8.3	Region growing tool	322
6.8.4	Vessel tree segmentation tool	324
6.8.5	Watershed segmentation tool	326
6.8.6	Multi-segment growing tool	328
6.8.7	Segmented structures regions growing Tool	330
6.9	Union, subtraction and intersection of structures	331
6.9.1	Union	331
6.9.2	Subtraction	332
6.9.3	Intersection	333
6.9.4	«Subtract dilated» Tool	334
6.10	Building Mask with Contours	335
6.10.1	General Information	335
6.10.2	Building a Structure Mask with Contours	336
6.10.3	Work with Contours	338

6.10.4	Setting the Contour Display Parameters . . . . .	338
6.11	Saving and Opening Segmentation Projects and DTI Projects . . . . .	340
6.11.1	Saving a Project . . . . .	340
6.11.2	Saving Projects Automatically . . . . .	342
6.11.3	Resuming Work with Segmentation Projects . . . . .	344
6.11.4	Opening a Project with Source DICOM Data . . . . .	346
6.11.5	Opening a Project without Source DICOM Data . . . . .	348
6.12	Histograms . . . . .	348
6.12.1	Rendering a Histogram for a Structure . . . . .	349
6.12.2	Histogram for a ROI . . . . .	350
<b>7</b>	<b>Vessel analysis module</b>	<b>352</b>
7.1	Open Studies in Vessel Analysis Module . . . . .	352
7.1.1	Vessels list . . . . .	355
7.2	«Render settings» Tool . . . . .	356
7.3	The Play Tool . . . . .	356
7.4	Video recording . . . . .	356
7.5	Image Filters . . . . .	357
7.6	Centerline building mode . . . . .	357
7.6.1	Building the centerline . . . . .	357
7.7	Vessel Analysis Mode . . . . .	360
7.7.1	Vessel borders . . . . .	361
7.7.2	Section analysis . . . . .	363
7.7.3	Curved surface analysis . . . . .	365
7.7.4	Export vessel surface mesh . . . . .	366
7.8	Coronary Artery Analysis . . . . .	366
<b>8</b>	<b>Cardiac function analysis</b>	<b>368</b>
8.1	Opening Studies in the Cardiac Function Analysis Module . . . . .	368
8.2	Tools for Cardiac Function Analysis . . . . .	370
8.3	Building Contours . . . . .	371
8.3.1	Building Contours Manually . . . . .	372
8.3.2	Evaluating the Left Ventricle Extension . . . . .	373
8.3.3	Contouring the Left Ventricle Endocardium and Epicardium Automatically . . . . .	374
8.3.4	Actions with Contours . . . . .	376
8.4	Evaluating Functional Parameters of the Heart . . . . .	376
<b>9</b>	<b>PET analysis</b>	<b>379</b>
9.1	Open Studies in PET Analysis tab . . . . .	379
9.1.1	Fuse series from the same study in the PET analysis tab . . . . .	380
9.1.2	Fuse series from different studies in the PET analysis tab . . . . .	381
9.1.3	Viewing Images of a Series in the PET Analysis Tab . . . . .	382
9.2	PET Analysis Tab Elements . . . . .	382
9.2.1	PET Analysis tab Windows . . . . .	382
9.2.2	Setting the templates for windows arrangement in the PET analysis tab . . . . .	383
9.3	MIP mode . . . . .	384
9.4	The Play Tool . . . . .	385

9.5	Video recording . . . . .	385
9.6	PET Window settings . . . . .	386
9.7	Image Positioning . . . . .	386
9.8	Visualize Images . . . . .	387
9.9	Measurements and Annotations . . . . .	388
9.10	Measure the Intensity Average and Standard Deviation in Space . . . . .	389
9.10.1	Create sphere . . . . .	390
9.10.2	Sphere location in space . . . . .	390
9.10.3	Actions with the sphere . . . . .	391
9.10.4	Drawing Parameters . . . . .	391
9.11	Synchronization in the PET analysis tab . . . . .	392
<b>10</b>	<b>Virtual Endoscopy</b>	<b>393</b>
10.1	Open Studies in Virtual Endoscopy window . . . . .	393
10.2	View Elements. Customize MPR Panel . . . . .	394
10.2.1	View Elements . . . . .	394
10.2.2	Customize MPR Navigation Panel . . . . .	395
10.3	Move Camera . . . . .	396
10.3.1	Move Camera Automatically . . . . .	396
10.3.2	Manage Camera Manually . . . . .	396
10.4	Video recording . . . . .	397
10.5	Customize Image . . . . .	398
10.6	Measurements and Markers . . . . .	398
10.7	Multiplanar Reconstruction . . . . .	398
10.8	Surface Reconstruction . . . . .	399
10.8.1	Create Surface . . . . .	399
10.8.2	Surface Orientation and Navigation . . . . .	400
10.9	Export . . . . .	401
<b>11</b>	<b>ECG Viewer</b>	<b>402</b>
11.1	Select Data Source . . . . .	402
11.2	Open Series in ECG View window . . . . .	402
11.3	View Graphs . . . . .	403
11.4	Toolbar . . . . .	404
11.4.1	Select Lead . . . . .	404
11.4.2	ECG Speed . . . . .	404
11.4.3	Scale . . . . .	405
11.4.4	Length Interval . . . . .	405
11.4.5	Value Interval . . . . .	405
11.4.6	Move to a Time Point on the Graph . . . . .	406
11.4.7	Set Up Coordinate Plane . . . . .	406
11.5	Frequency Filters . . . . .	407
11.6	Export series . . . . .	408
<b>12</b>	<b>Image annotation</b>	<b>409</b>
12.1	Licensing the Image Annotation Module . . . . .	410
12.2	Opening a Series in the Image Annotation Mode . . . . .	411
12.3	Creating a Tree of Object Groups and Classes . . . . .	412

12.3.1	Creating a New Class of Objects . . . . .	413
12.3.2	Creating a Group of Object Classes . . . . .	414
12.3.3	Operations with Object Classes and Groups . . . . .	414
12.3.4	Compatibility of Trees of Groups and Classes . . . . .	415
12.4	Export and Import of the Tree of Groups and Classes . . . . .	416
12.4.1	Export of the Tree of Groups and Classes . . . . .	416
12.4.2	Import of a Tree of Groups and Classes . . . . .	417
12.5	Marking Objects with Contours . . . . .	417
12.5.1	Actions with Object Contours . . . . .	418
12.5.2	Changing the Class of Object Contour . . . . .	419
12.6	Saving and Opening Annotation Results . . . . .	420
12.6.1	Saving Annotation Results . . . . .	420
12.6.2	Opening Annotation Results . . . . .	420
12.7	Export of Annotation Results . . . . .	421
<b>13</b>	<b>Network</b>	<b>423</b>
13.1	Services . . . . .	423
13.1.1	DICOM Service (PACS Server functionality) . . . . .	423
13.1.2	HIS/HTTP Service . . . . .	424
13.1.3	Web Access . . . . .	425
13.1.4	Secure DICOM Listener Service . . . . .	426
13.2	Set Up PACS Server Connection . . . . .	429
13.2.1	Add PACS Server . . . . .	430
13.2.2	Downloading Data from the PACS Server via WADO service . . . . .	431
13.2.3	Secure PACS Server connection via the TLS protocol . . . . .	432
13.2.4	Check PACS Server Availability . . . . .	434
13.2.5	Configuring the connection of two applications Inobitec DICOM Viewer . . . . .	435
13.3	Network Operation Status . . . . .	436
<b>14</b>	<b>The Local Storage</b>	<b>438</b>
14.1	View Storage Status . . . . .	438
14.2	Verify Storage . . . . .	439
14.3	Clear Storage . . . . .	439
14.4	Automatic Local Storage cleaning . . . . .	439
<b>15</b>	<b>Disk Creator</b>	<b>440</b>
15.1	General information . . . . .	440
15.2	Add Data to Disk Creator . . . . .	442
15.2.1	Automatically Add Data to a Disk Image . . . . .	442
15.2.2	Manually Add Data to a Disk Image . . . . .	442
15.2.3	Adding the Inobitec DICOM Disc Viewer to the Disk Image . . . . .	442
15.3	Burn image . . . . .	443
15.3.1	Write to Disk . . . . .	443
15.3.2	Write to Memory Card or Folder . . . . .	444
15.3.3	Burn an image to CD / DVD in Linux and macOS operating systems . . . . .	445
15.4	View studies written on disk . . . . .	445

<b>16 DICOM Viewer Settings</b>	<b>446</b>
16.1 General	447
16.2 User interface	448
16.3 Behavior	448
16.4 DICOM	449
16.5 Screen	450
16.5.1 Setting an Additional Monitor	450
16.5.2 Customizing the Screen Parameters	451
16.5.3 High resolution monitor support	453
16.6 Skins	453
16.7 Modules	454
16.7.1 Set Up Image Viewer Module	454
16.7.2 Set Up Study List Module	456
16.7.3 Set Up 3D Reconstruction Module	456
16.7.4 Set Up Vessel Analysis Module	458
16.7.5 Set Up Network Support Module	458
16.7.6 Set Up Local Storage Module	458
16.7.7 Set Up «DICOM CD/DVD Creator»	459
16.7.8 Set Up PET Analysis Module	459
16.8 Set Up Hotkeys Module	459
16.9 Import and Export Settings	462
16.9.1 Export Settings	462
16.9.2 Import Settings	462
16.9.3 Import CLUTs	463
<b>17 DICOM Tag Viewing</b>	<b>464</b>
17.1 DICOM Tags. General Information	464
17.2 DICOM Tag Viewer Window	465
17.2.1 Toolbar	466
17.2.2 Tag Tree	467
17.2.3 Search	467
17.3 Anonymize studies and series	467
<b>18 Report Editor</b>	<b>471</b>
18.1 Editor Window	471
18.1.1 Toolbar	472
18.1.2 Text Editing Tools	473
18.2 Working with Reports	477
18.2.1 Creating an Empty Report	477
18.2.2 Creating a Report Based on a Template	478
18.2.3 Saving a Report	479
18.2.4 Exporting a Report	480
18.2.5 Viewing and Editing a Report	480
18.3 Report Template	480
18.3.1 Creating an Empty Template	481
18.3.2 Loading a Report Template from a File	482
18.3.3 Exporting a Report Template	482
18.3.4 Viewing and Editing a Report Template	482

18.3.5	Saving a Report Template . . . . .	482
18.3.6	Deleting a Report Template . . . . .	483
<b>19</b>	<b>Print Images</b>	<b>484</b>
19.1	Working with Print List . . . . .	484
19.1.1	Add/Delete Images in View Flat Images and Fusion windows . . . . .	485
19.1.2	Add Images in Multiplanar Reconstruction and Volume Reconstruction windows . . . . .	485
19.1.3	Add Series and Clear Print List . . . . .	486
19.1.4	Add Images from Different Studies . . . . .	486
19.2	Edit print list in Preview window . . . . .	486
19.2.1	Preview . . . . .	486
19.2.2	Set Up Page Templates . . . . .	489
19.2.3	Cells . . . . .	491
19.2.4	Print Labels . . . . .	491
19.2.5	Reference image . . . . .	492
19.3	Print Images on Film . . . . .	493
19.3.1	Set Up DICOM Printers . . . . .	493
19.3.2	Set Up DICOM Printing Parameters . . . . .	495
19.3.3	Setting Up the Default DICOM Print Parameters . . . . .	495
19.3.4	Print . . . . .	496
19.4	Print Images on Paper . . . . .	497
19.5	Printing Pages Export . . . . .	497
<b>20</b>	<b>Integration</b>	<b>498</b>
20.1	Launch from the Command Line . . . . .	498
20.2	Launching the DICOM Viewer with a URL Command . . . . .	500
20.2.1	Enabling the DICOM Viewer Launch with a URL Command on Windows . . . . .	500
20.2.2	Enabling the DICOM Viewer Launch with a URL Command on Linux . . . . .	500
20.2.3	Enabling the DICOM Viewer Launch with a URL Command on macOS . . . . .	500
20.2.4	Launching the DICOM Viewer with the help of a URL Command . . . . .	500
20.3	HTTP RPC service . . . . .	502
20.3.1	Command «DownloadAndOpenStudy» . . . . .	502
20.3.2	Command «DisplayStudy» . . . . .	503
20.3.3	Configuration Files of HTTP RPC service . . . . .	504
<b>21</b>	<b>Licensing</b>	<b>507</b>
21.1	Trial period . . . . .	507
21.2	The First Launch and Licensing . . . . .	507
21.2.1	Registration on the License Server Using Internet . . . . .	507
21.2.2	License Proxy Server for automated corporate licensing . . . . .	508
21.3	Purchase of a License . . . . .	508

---

<b>22 Help System and User Assistance</b>	<b>509</b>
22.1 Help System . . . . .	509
22.1.1 Launch the Help System . . . . .	509
22.1.2 Help System Settings . . . . .	510
22.2 Tooltips . . . . .	510
<b>“Hotkeys”</b>	<b>511</b>
<b>Index</b>	<b>517</b>
<b>Glossary</b>	<b>517</b>

# About this Manual

This User Manual describes the functionality of Inobitec DICOM Viewer (version 2.15) and provides instructions on how to use this software product.

## Accepted Conventions

Names of program interface elements, key names and important notes are printed in **bold**.

Image captions are printed in *italics*.

The page numbers which contain a detailed description of the subject are printed in **bold** in the Index.

## Warnings

Warnings are used to attract attention to important information. Warnings may be marked with the following symbols:



**Notifies the user that there is a great chance of unexpected and potentially hazardous effect.**



**Is used to attract the user's attention to important notes, advice and recommendations.**



---

# Technical Support

Technical support of Inobitec DICOM Viewer users is provided by the Inobitec Software FZ-LLC team. If you apply for technical support, please include the following information in your message:

- your computer OS name, version and bitness (you can get this information from your system administrator);
- DICOM Viewer version (e.g. 2.3.0.6631). To get your version number, select the **About...** item from the main **Help** menu;
- product code. To find out the product code, select the **License...** item from the main **Help** menu.

To apply for technical support, or if you have any further questions or comments, please email us at [support@inobitec.com](mailto:support@inobitec.com)

## About the Product

Inobitec DICOM Viewer software is intended for visualization, analysis and printing of medical data obtained from various DICOM equipment (modality). The program can be installed on a diagnostic workstation and integrated with PACS. Inobitec DICOM Viewer brings the capabilities of diagnostics to the new level and makes it possible to detect an abnormality in due time, effectively predict its development and carefully plan the treatment.

To diagnose the Inobitec DICOM Viewer software should only be used by specialists who have the necessary qualifications in the relevant field.

Inobitec DICOM Viewer software product and installer does not:

- collect and transfer confidential user information;
- intercept network traffic;
- show ads;
- send spam;
- show messages not related to work;
- automatically update itself without notifying the user.

After uninstalling you do not need to restore your operating system and browser settings. Uninstalling is free of charge. Uninstalling does not adversely affect the operation of the computer and installed software. Files not related to the DICOM Viewer are not removed and changed after uninstalling. The DICOM Viewer functionality, installing, uninstalling, licensing are fully described in this User Manual on the website [inobitec.com](https://inobitec.com). License Agreement is available from the link <https://inobitec.com/about/viewerLic/>.

The DICOM Viewer is available in two editions:

- **Lite:** contains sufficient functionality for high-grade work, including storage and transfer of information on a network. This edition does not contain tools for conducting highly specialized studies. Its cost is much lower than the cost of the Pro edition.
- **Pro:** contains all the functionality which is currently available. In the User Manual the description of the functionality is marked with the symbol «<sup>PRO</sup>».

The edition of the DICOM Viewer which is recorded on the disk and the memory card contains minimal functionality for viewing studies by patients.

Starting from version 1.11.0, specialized modules can additionally be connected to the Pro edition. Such modules are licensed and paid for separately. The main functionality remains

available in the Pro edition. In the User Manual the description of additional functionality is marked with the symbol «**ADD**».

If the functionality is not available in the current edition, then a corresponding warning appears. It indicates in which edition the functionality is available.

32-bit and 64-bit builds are available for Windows operating systems. 64-bit builds are available For Linux and macOS. You can install only a 32-bit build of the program on a computer with a 32-bit operating system, and any build on a computer with 64-bit one, but it is recommended to install 64-bit, since it uses computer resources more efficiently. The functionality that requires a large amount of RAM is available only in 64-bit builds.

## DICOM Viewer Functionality

**INOBITEC Products Comparison Table**

DICOM Viewer features and tools	Lite	Pro	Web
General functions	✓	✓	✓
Multilingual user interface	✓	✓	✓
Autorun of the application	✓	✓	
Support for multiple monitors	✓	✓	
High resolution monitor support	✓	✓	✓
Full-screen mode	✓	✓	✓
Minimize application window to system tray	✓	✓	
Open/save file using Native OS dialogs	✓	✓	
Hotkeys	✓	✓	✓
Control of tools with different mouse buttons (left, right, or middle)	✓	✓	✓
Export and import settings	✓	✓	
Integrated help system	✓	✓	✓
Displaying phases	✓	✓	
Viewing structured reports (SR)	✓	✓	✓
Viewing DICOM tags	✓	✓	✓
Viewing PDF documents	✓	✓	✓
Voxel and polygon rendering support (CUDA, OpenCL, Metal, CPU)	✓	✓	
Showing the patient's name on the tab stub	✓	✓	✓

<b>DICOM Viewer features and tools</b>	<b>Lite</b>	<b>Pro</b>	<b>Web</b>
Displaying labels for images of the series and 3D reconstruction	✓	✓	✓
Highlighting tag labels and other information	✓	✓	
Remote viewing with restricted functionality via the Web Viewer		✓	
Integration with third-party systems	✓	✓	✓
Launching the program from the command line with parameters	✓	✓	
Executing commands via URL using the protocol inobitec://	✓	✓	
HTTP RPC service	✓	✓	
Opening a study by a link			✓
Basic measuring tools for series images and MPR slices	✓	✓	✓
Ruler	✓	✓	✓
Polygonal ruler	✓	✓	✓
Angle	✓	✓	✓
Cobb angle	✓	✓	✓
Point value	✓	✓	✓
ROI ellipse	✓	✓	✓
ROI rectangle	✓	✓	✓
ROI polygon	✓	✓	✓
Histogram display for ROI	✓	✓	
Measurement of speed and time interval for dopplergram	✓	✓	
Distance measurement on ultrasound studies	✓	✓	
Angle measurement between the rulers		✓	
Annotation tools for series images and MPR slices	✓	✓	✓
Ellipse	✓	✓	✓
Polygon	✓	✓	✓
Arrow	✓	✓	✓
Text	✓	✓	✓
Pencil	✓	✓	
Special tools	✓	✓	✓

<b>DICOM Viewer features and tools</b>	<b>Lite</b>	<b>Pro</b>	<b>Web</b>
Calibrating image sizes	✓	✓	✓
Digital Subtraction Angiography (DSA)	✓	✓	
Calcium scoring		✓	
Cardiothoracic ratio tool		✓	
Measurement of apparent diffusion coefficient (ADC)		✓	
Blood flow parameters evaluation on the basis of phase-contrast images		✓	
Visualization of Diffusion Tensor Imaging (DTI)		✓	
Fusion on the basis of differentiating color contrasting of series		✓	
Processing of display of series images and MPR slices	✓	✓	✓
Zoom	✓	✓	✓
True size	✓	✓	
Pan	✓	✓	✓
Magnifier	✓	✓	✓
Rotate	✓	✓	✓
Flip image	✓	✓	✓
Adjust W/L	✓	✓	✓
W/L settings	✓	✓	✓
Full dynamic W/L	✓	✓	
Custom W/L presets	✓	✓	
CLUTs	✓	✓	✓
User CLUTs	✓	✓	
Support for color lookup tables (CLUTs) embedded in DICOM data	✓	✓	
Choose image resampling filter	✓	✓	
Image filters (sharpen, blur, median)		✓	
Video recording and playback	✓	✓	✓
Play images	✓	✓	✓
Choosing a playback speed	✓	✓	✓
Playback looping	✓	✓	✓
Play video contained in DICOM files			✓

<b>DICOM Viewer features and tools</b>	<b>Lite</b>	<b>Pro</b>	<b>Web</b>
Video recording		✓	
Choosing an encoder for video recording		✓	
<b>Export images</b>	✓	✓	✓
View screenshot	✓	✓	✓
Visible image screenshot	✓	✓	
Raw image data capturing	✓	✓	
Export images to a new series of DICOM images	✓	✓	✓
Export images to a graphic file (JPEG, PNG)	✓	✓	
<b>Opening DICOM studies from various sources</b>	✓	✓	✓
Opening DICOM studies from a folder	✓	✓	✓
Opening DICOM studies from a PACS server	✓	✓	
Opening DICOM studies from a local storage	✓	✓	✓
Opening DICOM studies from zip archives	✓	✓	
DICOMDIR reading	✓	✓	
Loading images in the background	✓	✓	
<b>Work with DICOM studies</b>	✓	✓	✓
Uploading to the PACS server with storeSCU	✓	✓	✓
Downloading from the PACS server with C-GET and C-MOVE	✓	✓	✓
Work as a PACS server, support C-FIND, C-MOVE and C-STORE	✓	✓	
Export studies and series to the folder	✓	✓	✓
Export studies and series to the zip archive	✓	✓	✓
Search for studies	✓	✓	✓
Saving the search parameters	✓	✓	
Editing patient name and discription of study in local storage	✓	✓	
Anonymize studies and series with the ability to edit DICOM tags	✓	✓	
Downloading from the PACS server via WADO	✓	✓	
The support of secure connection with TLS		✓	
<b>View images</b>	✓	✓	✓

<b>DICOM Viewer features and tools</b>	<b>Lite</b>	<b>Pro</b>	<b>Web</b>
Customized split screen	✓	✓	✓
Displaying several studies at the same time	✓	✓	✓
Scrolling images	✓	✓	✓
Opening series from the context menu	✓	✓	✓
Customized arrangement depending on the study modality	✓	✓	
Automatic filling of windows with study series	✓	✓	
Building orthogonal projections	✓	✓	
Merge series into a multiphase series	✓	✓	
<b>Data synchronization</b>	✓	✓	✓
Synchronizing Window / Level for images	✓	✓	✓
Synchronize moving and zooming for images	✓	✓	✓
Synchronizing the image change	✓	✓	✓
Synchronization modes (automatic and manual synchronization)	✓	✓	✓
3D cursor	✓	✓	✓
Displaying slice projections	✓	✓	✓
Synchronization of MPR tabs on different monitors	✓	✓	
<b>MPR</b>	✓	✓	✓
Viewing axial, frontal, and sagittal sections	✓	✓	✓
Rotate cutting planes	✓	✓	✓
Setting MPR modes (Average, MIP, MinIP)	✓	✓	✓
Set slice thickness	✓	✓	✓
Display of MPR planes on 3D model	✓	✓	
Customizing windows arrangement		✓	
Export sections of any of the planes with a selectable increment to a series		✓	
Fusion on the basis of differentiating color contrasting of series		✓	
Viewing Diffusion Tensor Imaging series (DTI)		✓	
Curvilinear reconstruction		✓	✓
Curve slices		✓	
<b>Basic editing tools for a 3D model</b>	✓	✓	✓

<b>DICOM Viewer features and tools</b>	<b>Lite</b>	<b>Pro</b>	<b>Web</b>
Canceling and reverting changes	✓	✓	✓
Polygon cut	✓	✓	✓
Inverse Polygon Cut	✓	✓	✓
Cut object	✓	✓	
Cut all except object	✓	✓	
<b>Measuring tools for a 3D model</b>	✓	✓	
Ruler	✓	✓	
Polygonal ruler	✓	✓	
3D Angle	✓	✓	
Surface ruler		✓	
<b>Markers for MPR and 3D reconstruction</b>	✓	✓	
Point marker	✓	✓	
Line marker	✓	✓	
Polygonal line marker	✓	✓	
<b>Volume reconstruction (3D)</b>	✓	✓	✓
MIP (Maximum Intensity Projection)	✓	✓	
Clipping box	✓	✓	
Switching projection	✓	✓	
Remove bones	✓	✓	
Remove table	✓	✓	
Center of model	✓	✓	
Setting render quality of the model	✓	✓	
Export of several images obtained by rotating the model to a graphic file (jpg, png)	✓	✓	
Export of several images obtained by rotating the model to a new series of DICOM images	✓	✓	
Deleting bone structures with the help of a native series		✓	
<b>Segmentation</b>		✓	
Showing the editing mask and its outline		✓	
Canceling and reverting changes		✓	
Polygon cut		✓	



DICOM Viewer features and tools	Lite	Pro	Web
Inverse polygon cut		✓	
Cut object		✓	
Cut all except object		✓	
Brush cut		✓	
Brush restore		✓	
Segmentation from point by mask		✓	
Region growing		✓	
Vessel tree segmentation		✓	
Watershed segmentation		✓	
Region growing of segmented structures		✓	
Contour segmentation		✓	
Boolean operations with structures		✓	
Grow/Shrink		✓	
Creating a surface with a mask		✓	
Export surface (PLY, OBJ, STL, GLB)		✓	
Import surface (PLY, OBJ, STL)		✓	
Series fusion		✓	
Stitch images		✓	
Export of volume stitching		✓	
Series fusion from one study		✓	
Series fusion from different studies		✓	
Subtracting images		✓	
Fit layers by points		✓	
Merge layers automatically		✓	
Merge layers manually		✓	
Image registration		✓	
Recording a study on a CD/DVD	✓	✓	
Recording data to CD/DVD	✓	✓	
Recording a study on a USB medium	✓	✓	
Recording several studies	✓	✓	

<b>DICOM Viewer features and tools</b>	<b>Lite</b>	<b>Pro</b>	<b>Web</b>
<b>Print</b>	✓	✓	
Print images on paper	✓	✓	
Print images using a DICOM printer	✓	✓	
Arbitrary arrangement of images on the page	✓	✓	
Images arrangement templates	✓	✓	
Adding images to the header and the footer	✓	✓	
Changing several images simultaneously	✓	✓	
Adding reference images	✓	✓	
Exporting pages to the PACS server for printing	✓	✓	
<b>Virtual endoscopy</b>		✓	
Manually navigate the inside a cavity		✓	
Automatic synchronization with multiplanar reconstruction		✓	
Centerline		✓	
Fly-through camera		✓	
Cavity scan		✓	
Build cavity surfaces		✓	
Video recording		✓	
<b>Perfusion parameters estimation</b>		✓	
CT and MRI studies support		✓	
Results of perfusion parameters evaluation in the form of CBV, CBF, MTT, and Tmax maps		✓	
<b>Creation of report</b>		✓	
Edit and format text		✓	
Create and edit tables		✓	
Insert images from the clipboard		✓	
Create report templates		✓	
Autocompletion of tag values from study series		✓	
Export a report in a PDF file		✓	
Export a report in a DICOM DOC series		✓	
<b>View ECG</b>	✓	✓	✓

<b>DICOM Viewer features and tools</b>	<b>Lite</b>	<b>Pro</b>	<b>Web</b>
View graphs	✓	✓	✓
Measure time intervals and values on graphs	✓	✓	✓
Using filters		✓	✓
Export graphs to a new series of DICOM images		✓	✓

«Web» is the Inobitec Web DICOM Viewer, an individual product with the functions comparable to those of the desktop DICOM Viewer version. More information can be found in the [Products](#) and [Downloads](#) pages.

Additional modules to the Pro edition, purchased separately:

Name	Features and tools
Vessel Analysis	Bones deletion Displaying a section Building the centerline Vessel contours Editing vessel contours Lumen Short and long diameters Percentage of stenosis Export vessel surface
Coronary Artery Analysis	Displaying a section Building the centerline Vessel contours Editing vessel contours Lumen Short and long diameters Percentage of stenosis Export vessel surface
PET Analysis	Fusion PT and CT series SUV measurement VOI Sphere Customized split screen
Extended Segmentation	Saving the segmentation results in the .spj format Autosave
Image Annotation	Custom classes Combining classes in groups Marking objects with contours Saving image annotation results Export image annotation results with DICOM
Cardiac function analysis	Building contours for the left and right ventricle manually Building contours for the left ventricle automatically Evaluating the main parameters for the left and the right ventricle (EDV, ESV, SV, EF, CO, CI, myocardial mass) Volume graphs

## New Functions in Version 2.15

Function	Available in edition	
	Lite	Pro
Downloading series and studies by WADO	✓	✓
Display of the patient's name on the tab label	✓	✓
Opening series from the context menu for the image viewing tab	✓	✓
Colored labels for displayed tags and other information	✓	✓
Keyboard shortcuts for opening new tabs	✓	✓
The list of default tags for anonymization has been extended	✓	✓
Changed the logic of saving the state of visibility and collapsed structures in the list of the segmentation panel		✓
Keyboard shortcuts for changing projections for the image viewing tab		✓
Automatic construction of the left ventricle's outer border		+
Volume graphs for functional analysis of the heart		+

✓ — Functionality is available in this edition

+ — Functionality is available in an additional module to the Pro edition

# Installing, Uninstalling and Launching the Program

## System Requirements

### Minimum System Requirements

#### Operating system:

- Windows 7 32-bit;
- macOS version 10.13;
- Ubuntu version 18.04;
- Ubuntu version 20.04;

**RAM:** 2 GB;

**free disk space:** 300 MB;

**CPU:** 1,5 GHz;

**video card:** without hardware acceleration support;

**keyboard:** standard;

**mouse:** two-button with a scroll wheel;

**display:** resolution 1024x768;

**network card.**

### Recommended System Requirements

#### Operating system:

- Windows 7 64-bit and greater;
- macOS version 10.15 and greater;
- Ubuntu version 18.04;
- Ubuntu version 20.04;

**RAM:** 16 GB (for full-fledged 3D and 4D reconstruction);

**free disk space:** 500 MB;

**CPU:** 3 GHz (4 or more cores);

**video card:** GeForce GTX 700 series with embedded memory of 4 GB (with CUDA support). For optimal performance, when working with segmentation functions, we recommend to run the program on a hardware with Geforce GTX 1070 and up with minimum 8GB VRAM;

**keyboard:** standard;

**mouse:** two-button with a scroll wheel;

**display:** two displays, resolution HD 1920x1080;

**network card.**



**Rendering devices based on CUDA are not supported by 32-bit operating systems and macOS**

## Installing, Uninstalling and Running the Program on Windows

### Installing the Program using the Installer

To install the program:

1. Run the installer by double-click.
2. Click **CONTINUE** in the window shown in Fig. 1.

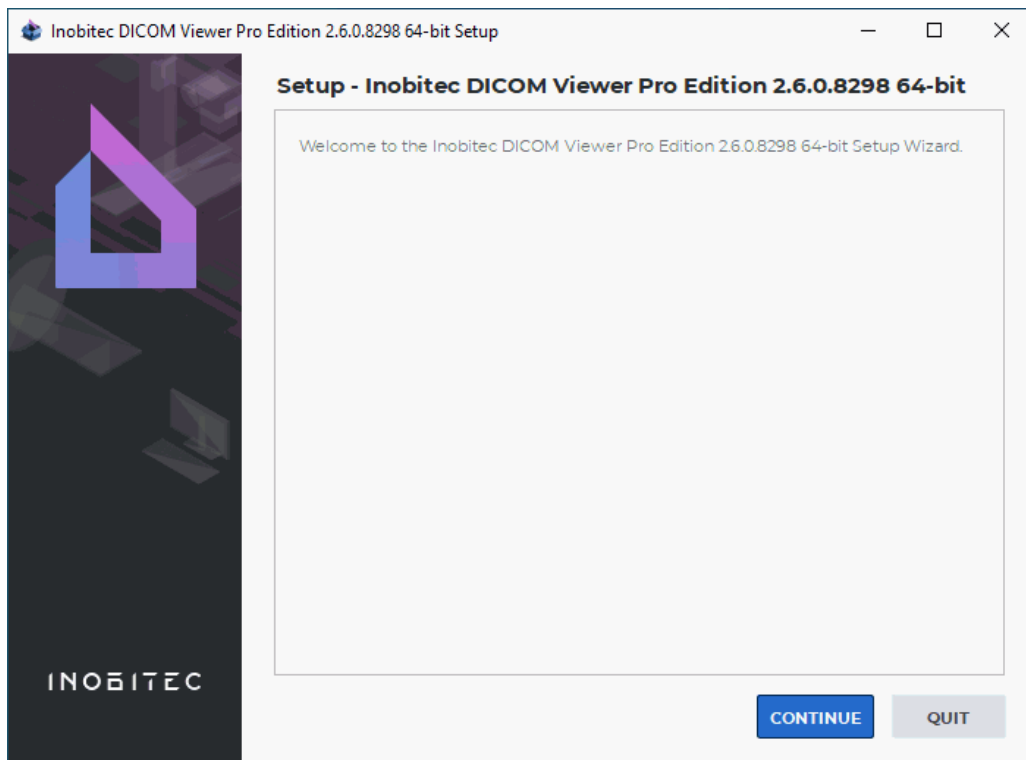

*Figure 1: Beginning of the installation*

3. It is strongly recommended to update graphics adapter drivers (integrated or discrete) from the official manufacturer's website, in order to prevent possible failure in operation of DICOM Viewer. If you are sure that drivers are up to date check the **The drivers on this device have been updated** box in the window shown in Fig. 2, and click **CONTINUE**. Otherwise stop installation (click **CANCEL** and in the confirmation dialog click **Yes**) and update drivers. To return to the previous installation step click **GO BACK**.



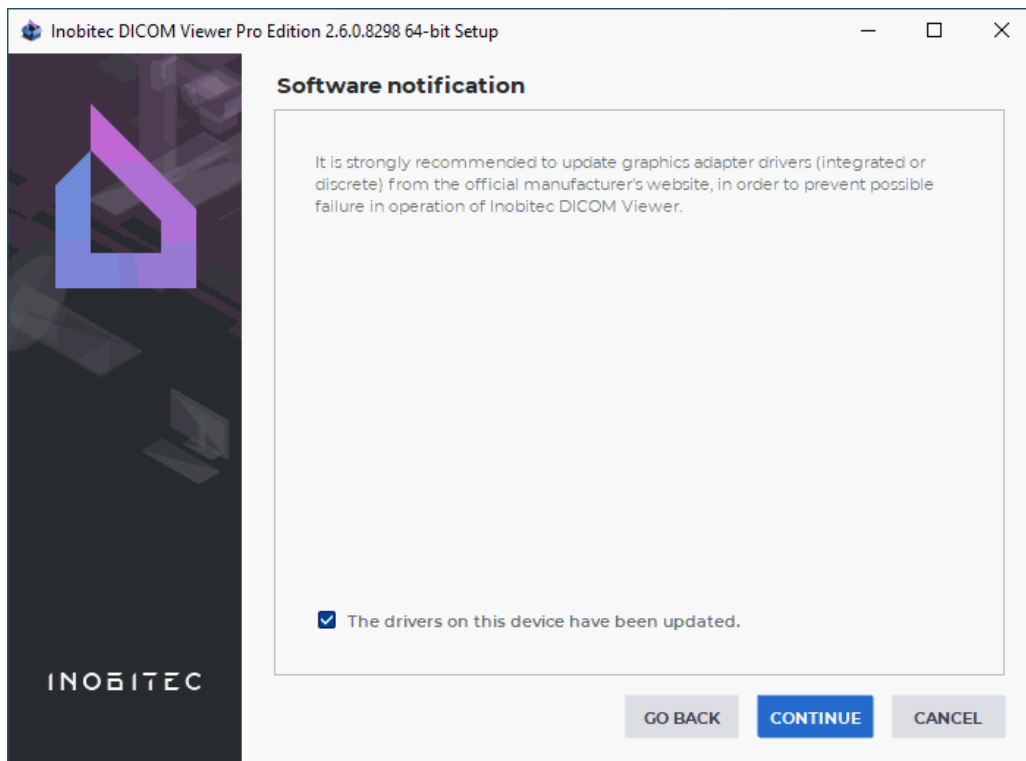

Figure 2: Software recommendation

4. Read the License Agreement carefully. Its text is also available from the link <https://inobitec.com/about/viewerLic/>. If you agree the terms and conditions, check the item **I accept the license** and click **CONTINUE** (Fig. 3). Otherwise click **CANCEL** and in the confirmation dialog box that appears click **Yes**.

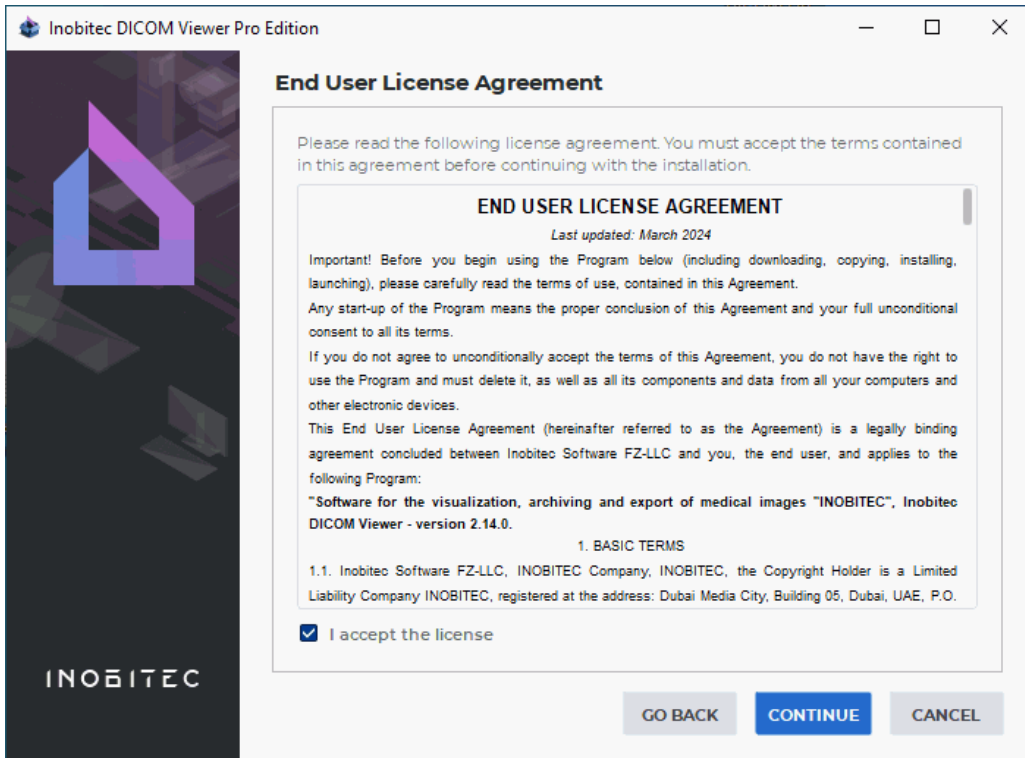

Figure 3: License Agreement

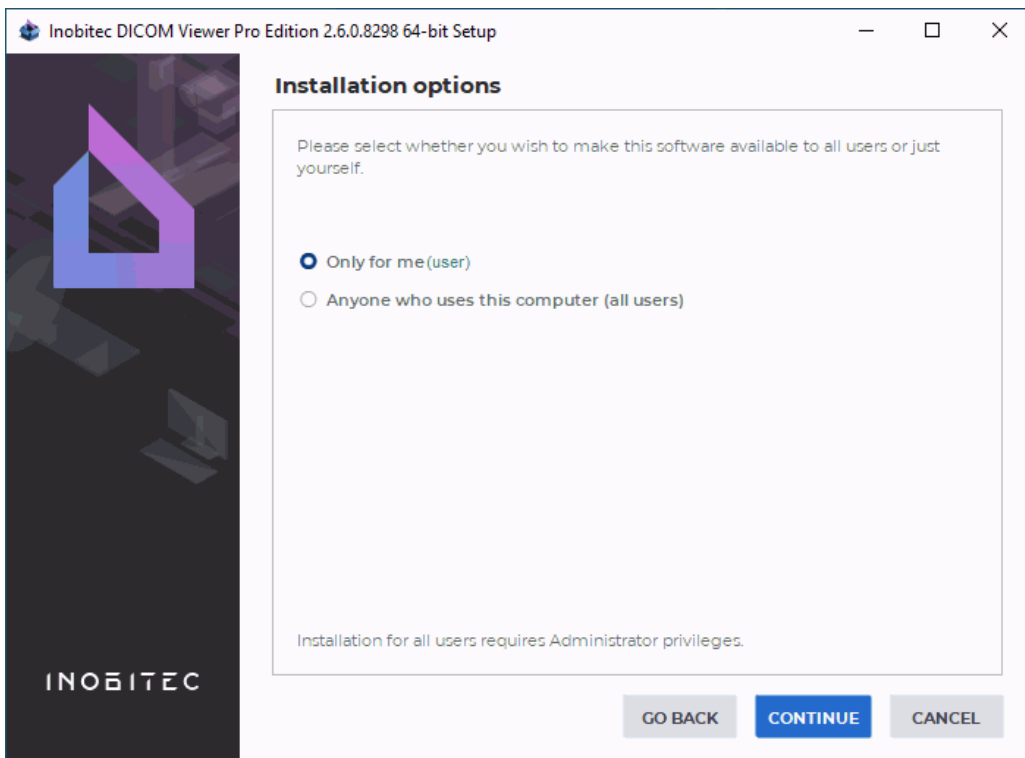

Figure 4: Select users

5. Select for whom you want to install the program (Fig. 4). If you select **Anyone who uses this computer (all users)**, then the program will be installed to the system folder, and you will need administrative privileges.
6. If necessary, change the Installation Folder (Fig. 5). We recommend leaving the default value. Click **CONTINUE**.

**Attention:**

- it is prohibited to specify a path with only the disk root (e.g. D:\);
- it is prohibited to specify folders created by other users and third-party software;
- when the program is being installed for all the users, specify a folder that can be accessed by all the users.

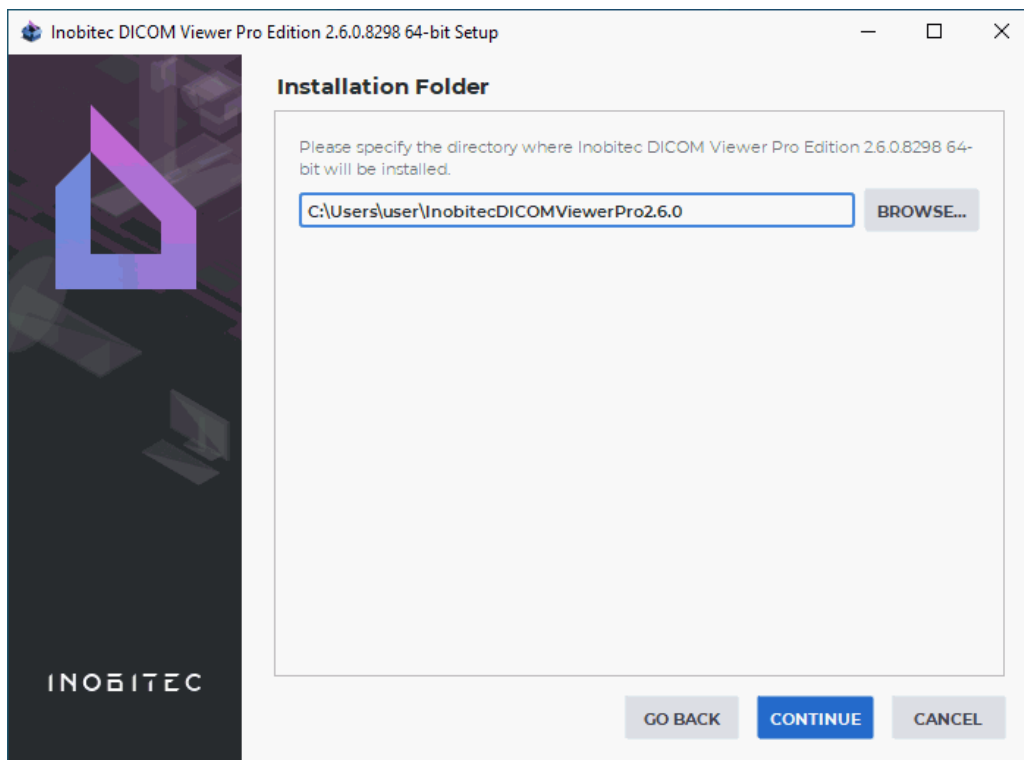

Figure 5: Installation Folder

7. If another version of the program is already installed in the selected folder, then the message **The directory you selected already exists and contains an installation. To install the product the installation will be uninstalled first** will be displayed.

To uninstall, click **Yes**. The uninstaller will start (see the Section **Uninstalling the Program on Windows**). After the uninstall the installation will continue.

To leave the already installed version of the program and select a new folder to install, click **No** and in the window shown in Fig. 5, specify another folder.

8. If you select installation for all users, then you need to specify the Common Directory to store the program service information (Fig. 6). If necessary, change the path to the Common Directory. We recommend leaving the default value. Click **CONTINUE**.

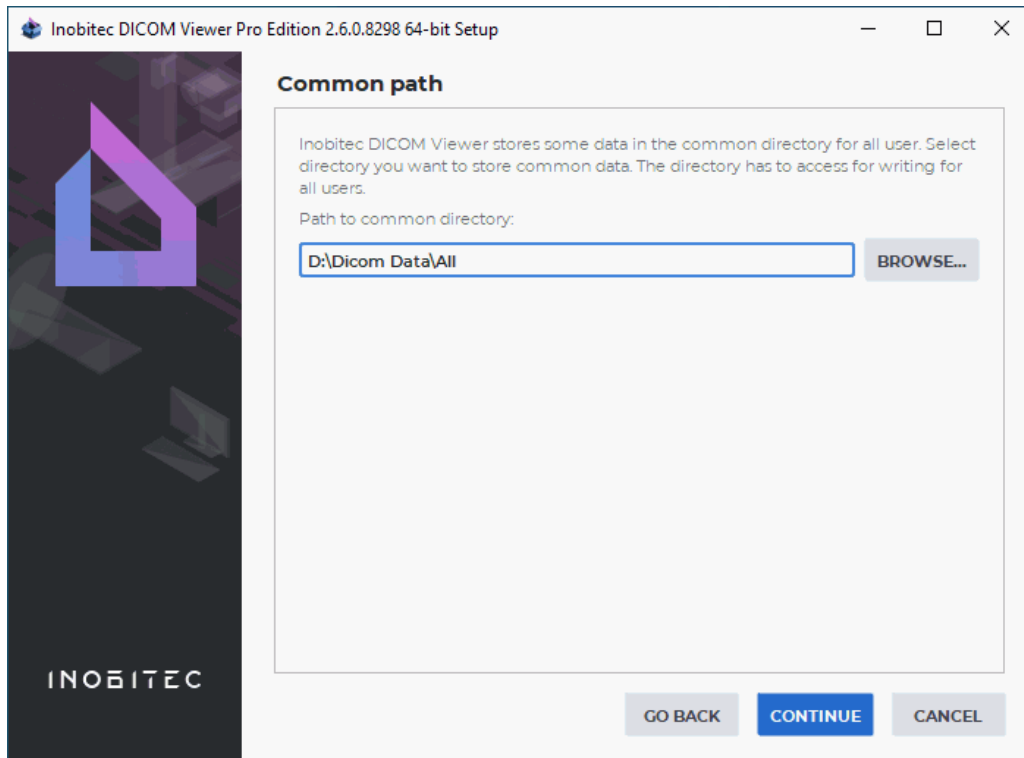

Figure 6: Common Directory for service information

9. If the DICOM Viewer is meant to be integrated with third-party systems, activate the program launch with the help of URL commands by checking the **Register the schema «inobitec» to launch a viewer with parameters from browser** box in the **Extended parameters** window (Fig. 7). The box is unchecked by default. For details on how to launch the program with URL commands, see Section 20.2.
10. To enable launching the DICOM Viewer and opening studies via the Explorer context menu, check the **Launch the viewer from the context menu** box in the **Extended parameters** window (Fig. 7). The box is checked by default. For details on opening studies from the context menu, see Section 1.5.4. After the program is installed, this function can be controlled from the **Behavior** section of the DICOM Viewer configuration window (see Section 16.3).

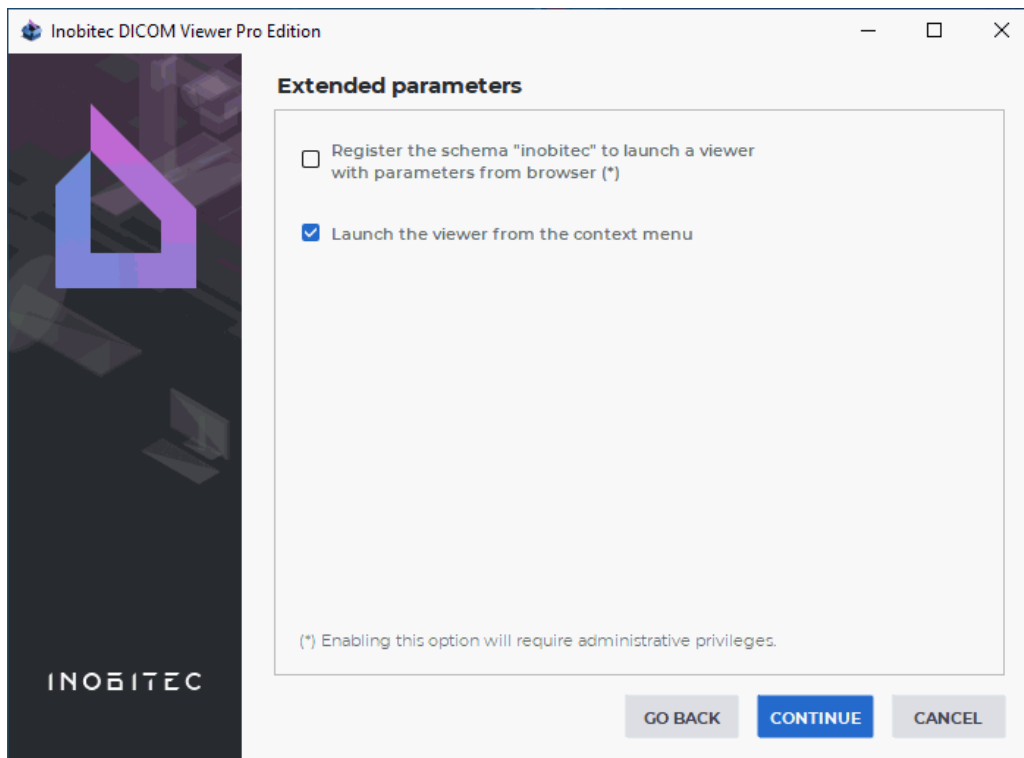

Figure 7: The **Extended parameters** window

11. In the **Select Components** window, (Fig. 8) select the required components by check the boxes. To expand or collapse the component tree, click on the symbols to the left of the component group name (highlighted in red and green in the Fig. 8):

- the **Help** group:
  - **Slideshow tips**: Compact movies for tooltips;
  - **Assistant (English)**: English integrated help system;
  - **Assistant (Russian)**: Russian integrated help system;
  - **User manual PDF (English)**: English user manual in PDF format;
  - **User manual PDF (Russian)**: Russian user manual in PDF format.
- the **Languages** group contains available languages.

For detailed information about a component select it with the mouse.

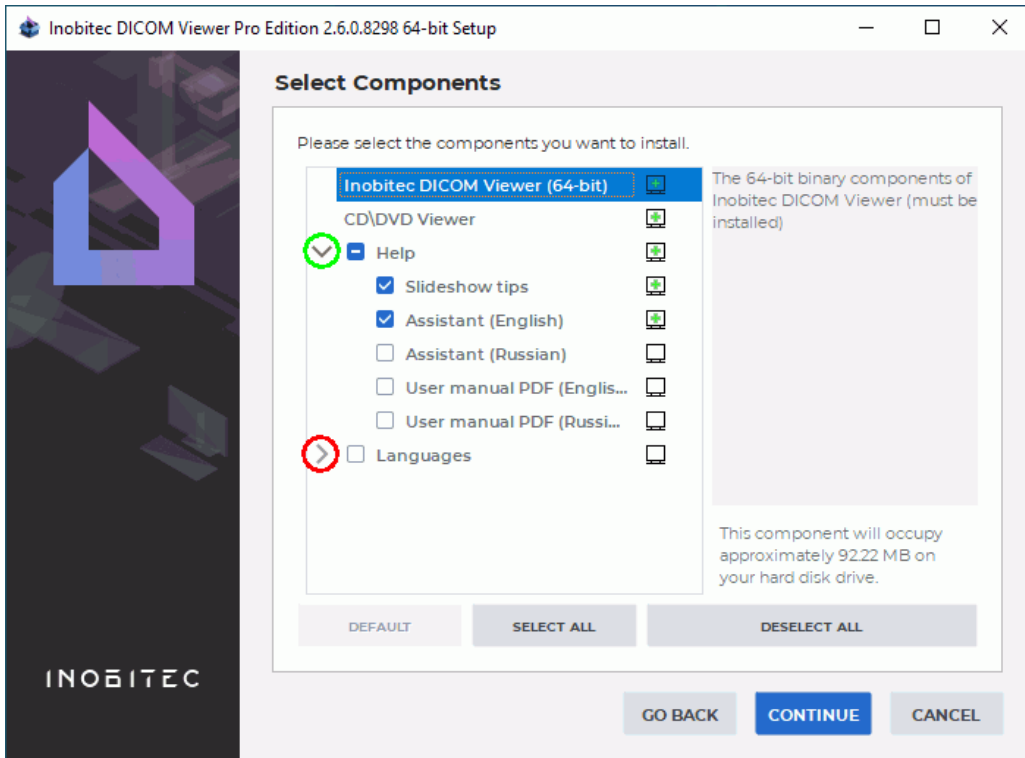

Figure 8: Select Components Window

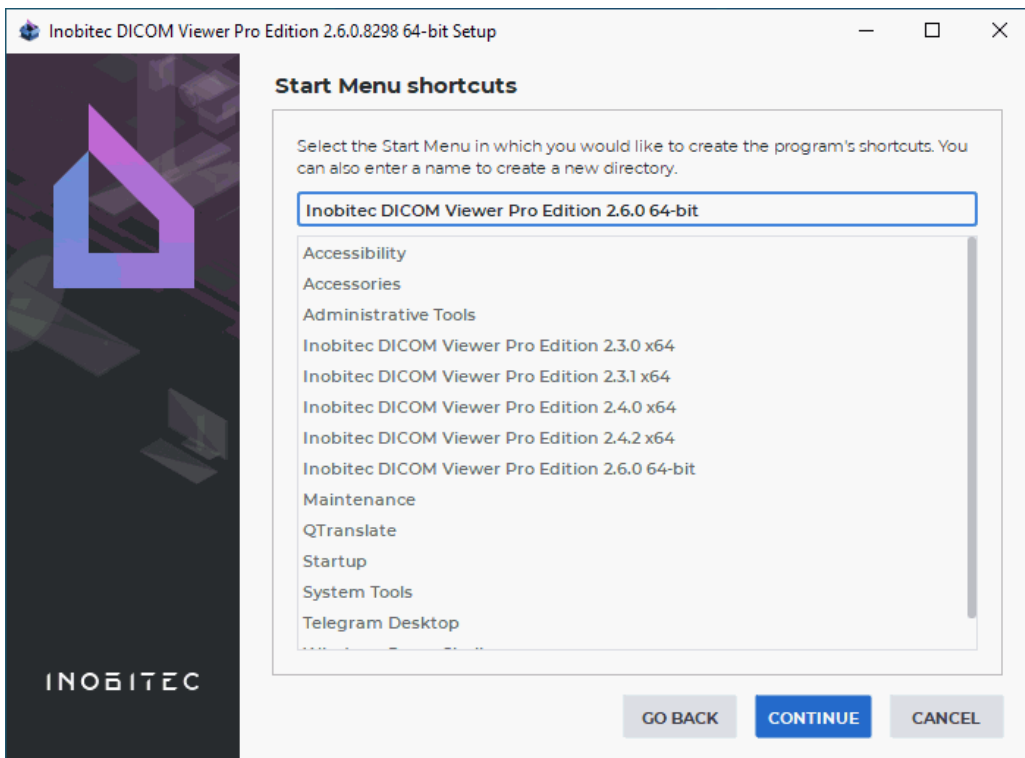
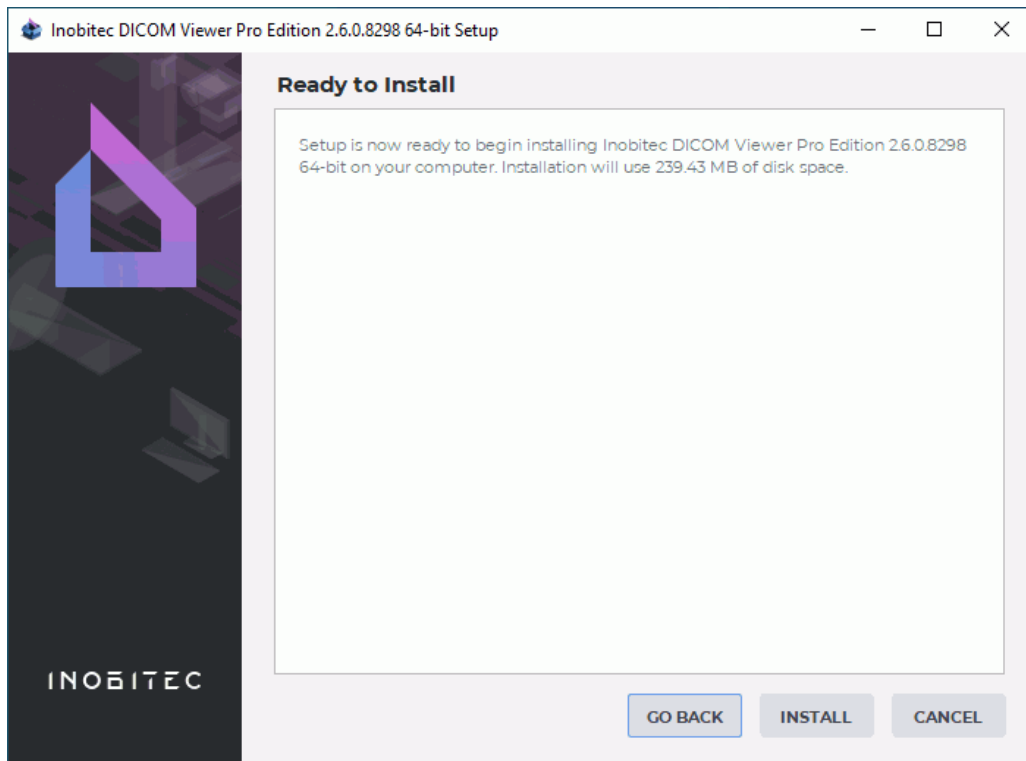

Figure 9: Start Menu Shortcuts

12. If necessary, change the folder for the program's shortcuts in the **Start** menu (Fig. 9). We recommend leaving the default value. Click **CONTINUE**.



*Figure 10: Confirm installation*

13. In the confirmation window click the **INSTALL** button (Fig. 10).

14. Wait until the installation process is complete (Fig. 11). Click the **DONE** button.

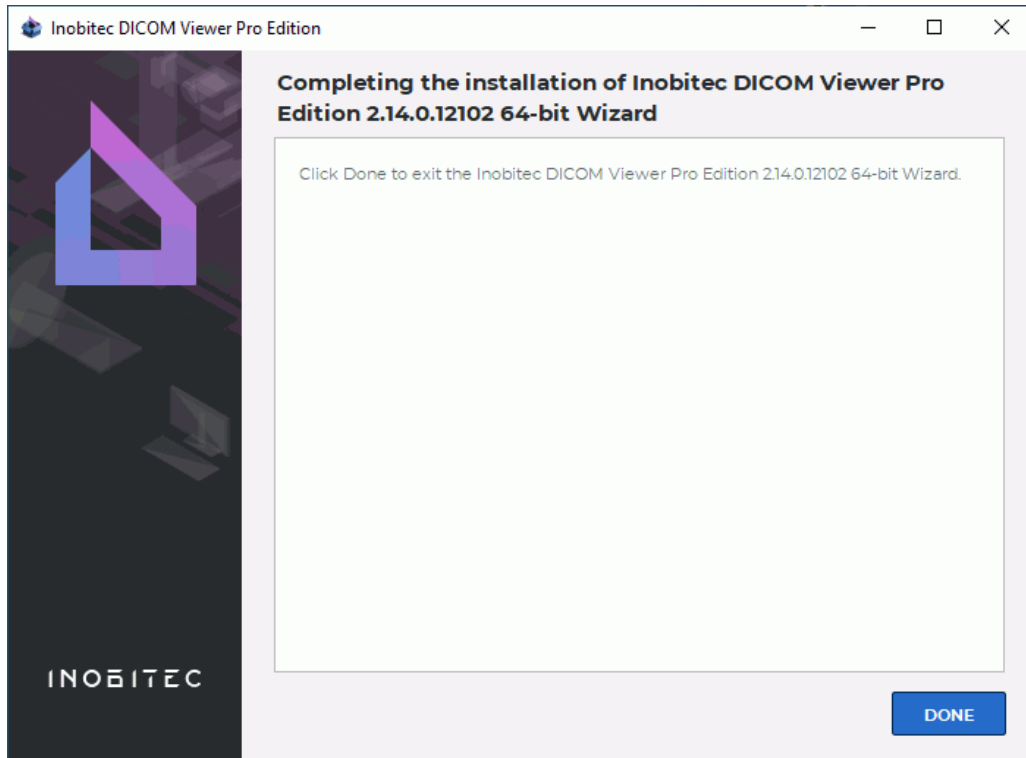

Figure 11: Installation complete

### Silent program Installation

Silent installation allows you to speed up and automate the process of installing the program by submitting the installation parameters to the installer through the file. Such installation can be launched automatically on domain computers using Microsoft Active Directory.

To prepare the installer for a silent installation:

1. Unpack the installer to a folder using an archiver (for example, 7-zip).
2. Go to the folder where the installer is unpacked.
3. Edit the following parameters in the **autoinstall.qs** file:
  - (a) **AllUsers = false** to install only for current user (by default) or **AllUsers = true** to install for all users;
  - (b) **TargetPathName**: path to folder to install the DICOM Viewer. If *AllUsers = true* then the default value is *C:\Program Files\InobitecDICOMViewer<Edition><Version>*, if *AllUsers = false* then default value is *C:\Users\<CurrentUserName>\InobitecDICOMViewer<Edition><Version>*. If necessary, specify another value.
  - (c) **CommonPath**: path to the common folder (only if *AllUsers = true*). The default value is *C:\ProgramData\InobitecDICOMViewer<Edition><Version>*. If necessary, specify another value. All users must have write access to the specified folder.
  - (d) **LocalStoragePath**: path to the local storage. The default value is *C:\Users\<username>\InobitecDICOMViewerWorkspace*.



- (e) **OptionsFilePath**: path to the file with settings exported from an already installed DICOM Viewer. For details on how to export settings see Section 16.9. If the file is not specified, the default settings are used.
- (f) **ForceInstall = false** to remove the previously installed version of the DICOM Viewer in the folder selected for installation.

If national characters are used save the **autoinstall.qs** file in utf-8 encoding.

To install the DICOM Viewer run the *silent\_install.bat* file. Log is written to file *%temp%\install%DATE%.log*, where *%temp%* and *%DATE%* are Windows system variables.

## Uninstalling the Program using an Uninstaller

To uninstall the program:

1. Run the uninstaller using one of the following methods:
  - (a) select **Inobitec Dicom Viewer -> Uninstall** in the **Start** menu or
  - (b) use **Programs and Features** in the **Control Panel**.
2. Make sure that the item **Remove all components** is selected in the window shown in Fig. 12 and click the **CONTINUE** button.

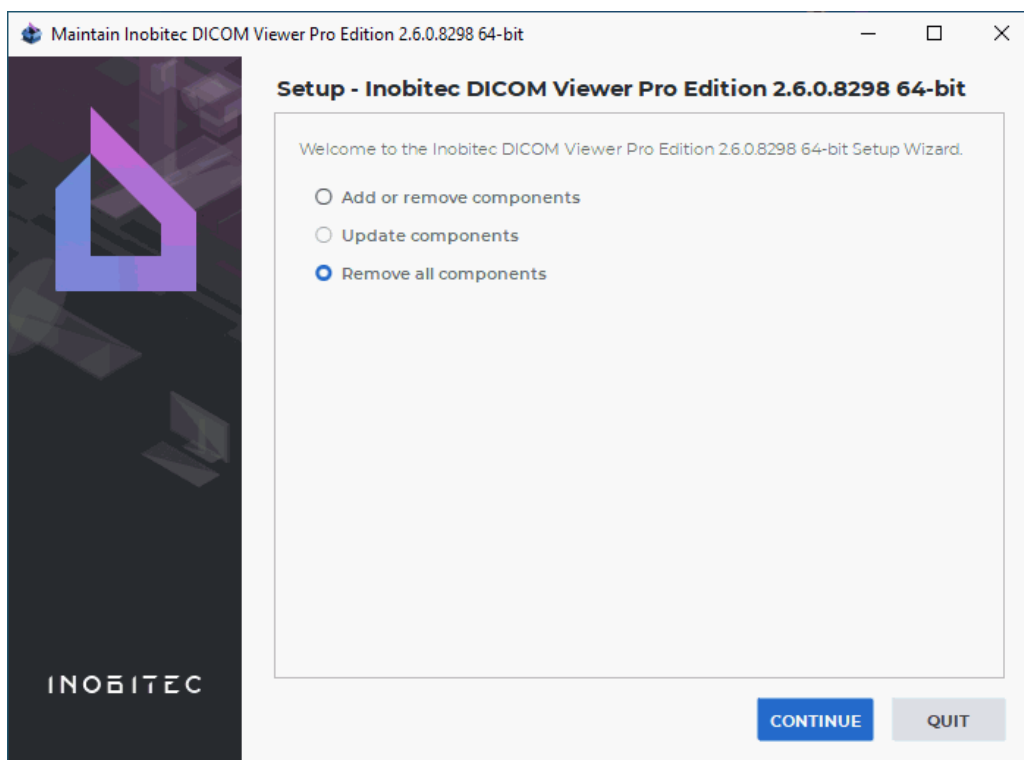

Figure 12: Beginning of the uninstallation

3. In the confirmation window click the **UNINSTALL** button (Fig. 13).

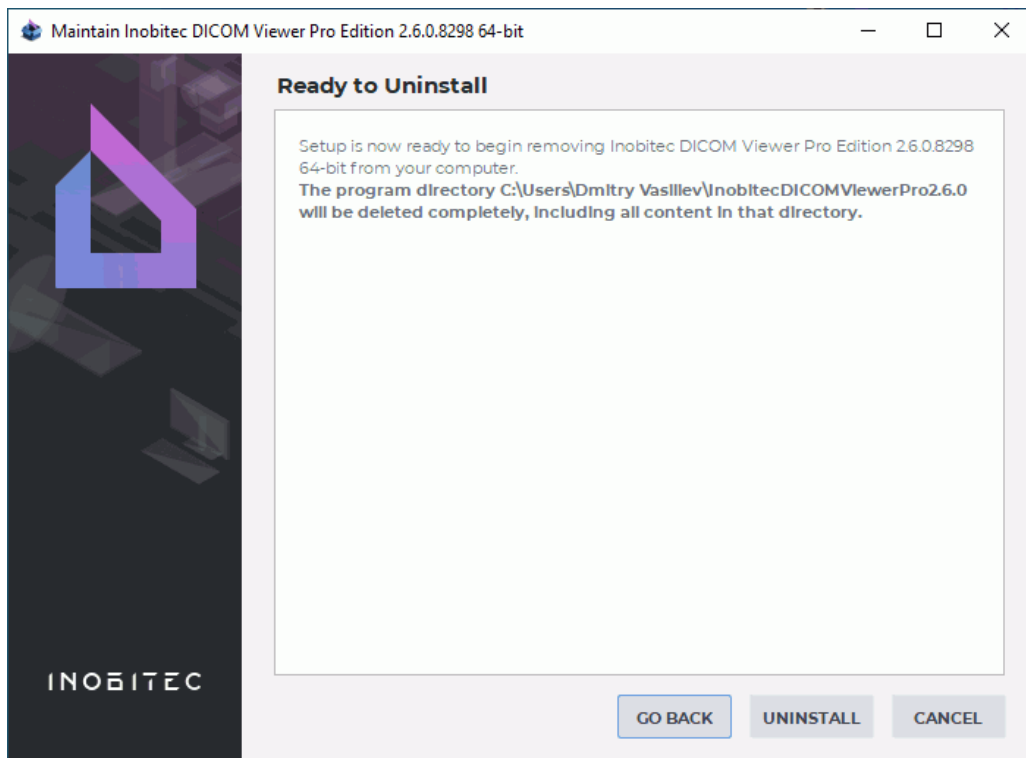

Figure 13: Confirm uninstallation

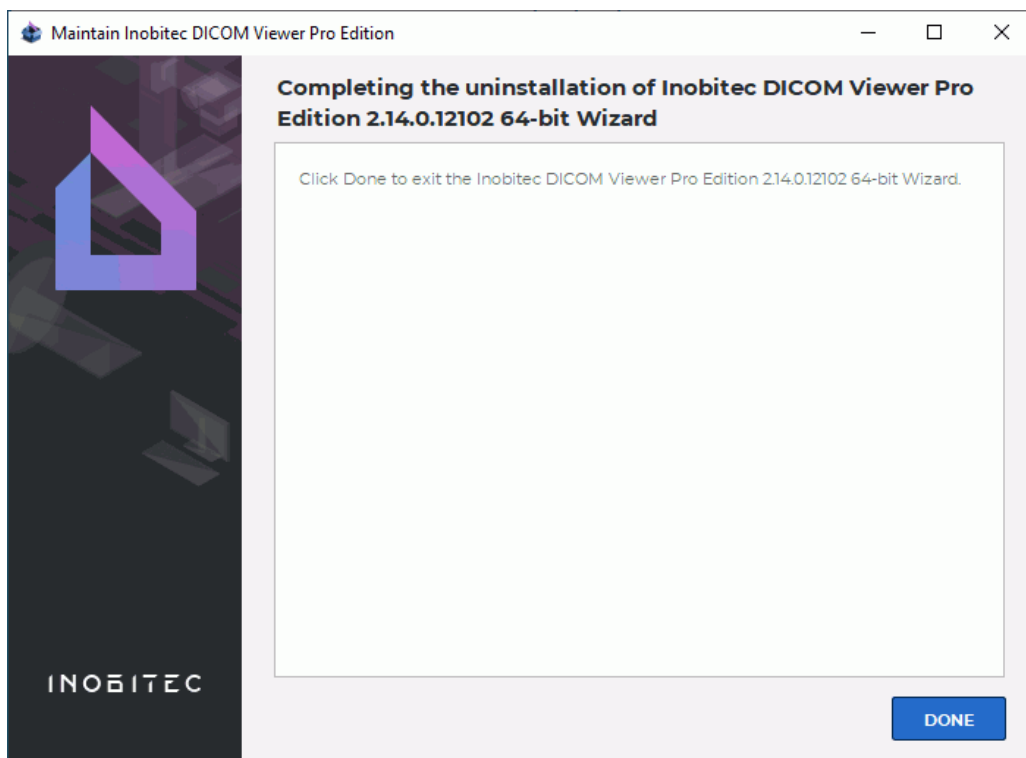

Figure 14: Uninstallation complete

4. In the confirmation window click the **DONE** button (Fig. 14).

## Silent Uninstallation the Program

Silent uninstallation allows you to automate the process of uninstalling of the program similar to silent installation.

To prepare the installer for a silent uninstallation:

1. Unpack the installer to a folder using an archiver (for example, 7-zip).
2. Go to the folder where the installer is unpacked.
3. Change the `<Disk:\Full\Path\To\Installed\DICOMViewer\You\Want\To\Uninstall>` text for the path to the folder with the DICOM Viewer to uninstall in the **silent\_uninstall.bat** file.

To uninstall the DICOM Viewer run the *silent\_install.bat* file. Log is written to the `%temp%\uninstall%DATE%.log`, where `%temp%` and `%DATE%` are Windows system variables.

## Running the Program

Starting from version 2.6 the DICOM Viewer shortcut in Windows operating systems is displayed in the format: **<Inobitec><Edition><Version>**.

The editions available are:

- **PRO** — professional;
- **LITE** — simplified;

For example *Inobitec PRO 2.6.0*.

Each version and edition of the DICOM Viewer installed in Windows has their own shortcuts on the Desktop and the Start Menu to ensure the convenience of launching.

To launch the program, double-click on the desktop shortcut or click on the shortcut from the Start menu.

On Windows, the DICOM Viewer may be launched by dragging and dropping the data folder on the program icon. The studies contained in the folder will be opened in a new tab **DICOM data in the folder**, and, depending on the data type, the first series of the first study on the list will be opened:

- In the Flat image viewing tab;
- In the ECG viewing tab;
- With the PDF viewer (if installed), by default;
- In the DICOM Tag Viewing tab, if the series cannot be opened in the above mentioned tabs/by the above mentioned programs.

If the DICOM Viewer has already been launched, the data will be opened in it. If there are no data in the folder to be displayed, an empty tab **DICOM data in the folder** will pop up.

You will find detailed information about launching the DICOM Viewer with third-party software and software suites in Chapter 20.

## Installing, Uninstalling and Running the Program on Mac OS

### Installing the Program

To install the program uncompress the dmg file and drag **DICOMViewer.app** into the open **Applications** folder. The icon  is displayed on the file while dragging. Release the mouse button and wait for the program installation to complete.

### Uninstalling the Program

To uninstall the program remove the **DICOMViewer.app** from the **Applications** folder.

### Running the Program

To launch the DICOM Viewer, go to the **Applications** folder and click on the **DICOMViewer.app** icon.

On macOS, the DICOM Viewer may be launched by dragging and dropping the data folder on the program icon. The studies contained in the folder will be opened in a new tab **DICOM data in the folder**, and, depending on the data type, the first series of the first study on the list will be opened:

- In the Flat image viewing tab;
- In the ECG viewing tab;
- With the PDF viewer (if installed), by default;
- In the DICOM Tag Viewing tab, if the series cannot be opened in the above mentioned tabs/by the above mentioned programs.

If the DICOM Viewer has already been launched, the data will be opened in it. If there are no data in the folder to be displayed, an empty tab **DICOM data in the folder** will pop up.

You will find detailed information about launching the DICOM Viewer with third-party software and software suites in Chapter 20.

## Installing, Uninstalling and Running the Program on Linux

### Running the program in Appliance Format

Inobitec DICOM Viewer software for Linux OS is comprised of only one file in **<InobitecDICOMViewer><Bitness><Edition><Version>** format with **Appliance** extension. The file contains the program with all the libraries required for its functioning.

Example: *InobitecDICOMViewer-linux-64-bit-pro-2.7.0.Appliance*.

To install and run the program in Appliance format, proceed as follows (for Ubuntu):

1. We advise you to transfer the downloaded Inobitec DICOM Viewer file from the *Downloads* file directory to the directory you need.

2. Provide the Applmage file a permission to be executed. For that purpose, mouse over the file and click the right mouse button. On the context menu, select **Properties**. When the **Properties** menu (Fig. 15) pops up, go to the **Permissions** tab and check the **Allow executing file as program** box. Close the **Properties** menu.
3. To run the program file, double-click on it with the left mouse button.

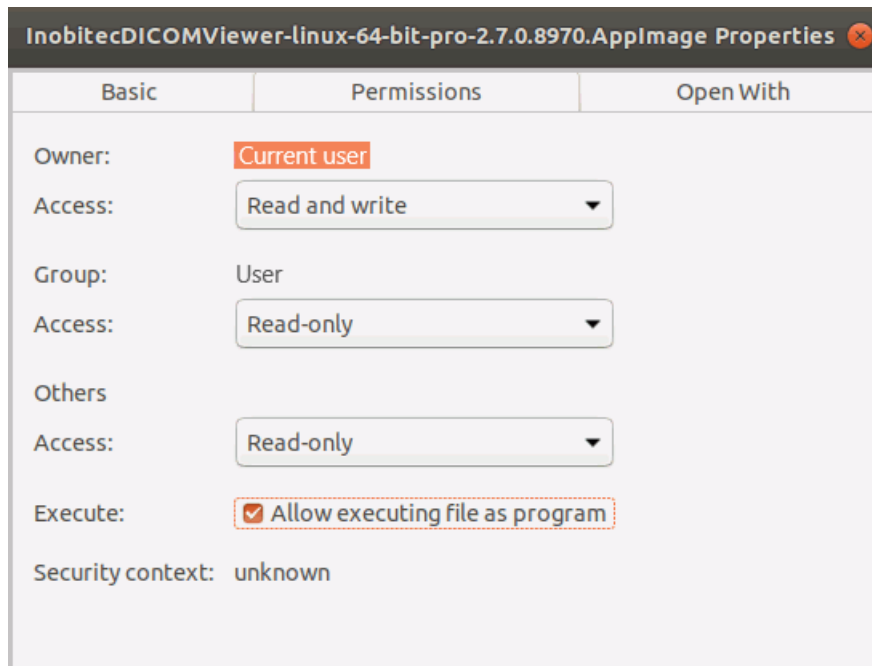

Figure 15: «Properties» menu

### If to run the Applmage you need to install FUSE

On Linux OS, **FUSE** (filesystem in userspace) software is required to work with Applmage files.

The Inobitec DICOM Viewer distribution for Linux OS in Applmage format requires **FUSE 2** functionality.

If the **FUSE 2** is not installed in your operating system, install and configure it manually. You will find detailed instructions on how to install and set up **FUSE 2** together with command examples at <https://docs.appimage.org/user-guide/troubleshooting/fuse.html>.

The resource may not be available. In this case you will have to find the information on installing and setting up **FUSE 2** on your system for yourself.

### Uninstalling the Program

To uninstall the program in Applmage format remove the file from the directory.

## Launch multiple instances of the program

If the DICOM Viewer has already been launched, you cannot launch this program again on the same computer. If you try to launch the DICOM Viewer again, the window of the launched program will be activated. If you try to launch the DICOM Viewer again with command line parameters, the parameters will be sent to the program that has already been launched (see Sections 20.1 and 20.2).

If the DICOM Viewer has already been launched and minimized to the system tray, the parameters will be sent to the current program regardless of the version and the edition chosen by the user (see Section 1.2).

If the program was launched on behalf of one user, it cannot be accessed by another user. In such a case, the current user has to shut down the program forcibly and then relaunch it. To do that, enable the **Allow to close the application running as different users** option in the program settings (see Section 16.3).

You can only launch another program version or edition after the currently running program is shut down.

Note that sometimes the program cannot exit immediately when the main window closes (e.g. if data is being transferred over the network, or if information is being written to a disk or flash card). In this case, if you try to launch the program, the main window of the launched instance does not open and you should wait until the launched instance exits and then launch the program again.

## Service files

Service files are located in the following folders, depending on the operating system:

Windows	C:\Users\<>Username>\AppData\Local\Inobitec\<>program name>
Linux	~/.local/share/Inobitec/<program name>
macOS	~/Library/Application Support/Inobitec/<program name>

The following files are service ones:

- log files (are located in the subfolder **Logs**);
- memory dumps, written if the program crashed (are located in the subfolder **Dumps**). Only for Windows;
- configuration files (are located in the subfolder **Configs**);
- CLUTs (are located in the subfolder **Configs**);
- 3D image renderer files (are located in the subfolder **OpenCL**).

E.g. *Smith* user's log files for *Inobitec DICOM Viewer Pro* version 1.9.1 installed in *Windows* are located in *C:\Users\Smith\AppData\Local\Inobitec\Inobitec DICOM Viewer Professional Edition 1.9.1\Logs* folder.

Path to log files can be changed (see Section 16.1).

## Getting Started

To avoid problems with the DICOM Viewer, do the following before you start working with the program:

1. Limit the access to the computers with the program installed in order to protect the patients' personal data.
2. If you need to print images on a DICOM printer, make sure that the printer is available and print a test page.
3. If you need to record data on a CD/DVD, make sure that the disk drive is available and make a test record.
4. If you need to download data from the modality to the local storage, check the modality connection settings by downloading test data. Errors may occur when studies are opened, depending on the modality settings (e.g. the modality may make an error in recording the width and the level of the window; in this case you will need to change the window width and level settings manually while viewing the images).
5. Make sure that the data downloaded from the modality can be viewed in the modes chosen (e.g. a study contains several phases for viewing images in the digital subtraction angiography mode).

Before starting a procedure that requires flawless operation of the DICOM Viewer, do the following:

1. If there is an uninterruptible power supply unit, make sure it is in working order.
2. Check the DICOM servers availability; depending on the tasks to be performed, check the ability to upload, download and search for data.
3. If you need to download studies in the local storage, check the amount of free space on the hard disk drive where this storage is placed.

## First run of the Program

When you first start the DICOM Viewer, the welcome panel opens (Fig. 16). The welcome panel may also be displayed at the first startup after the upgrade the DICOM Viewer. Initialization of the DICOM Viewer is performed in the welcome panel.

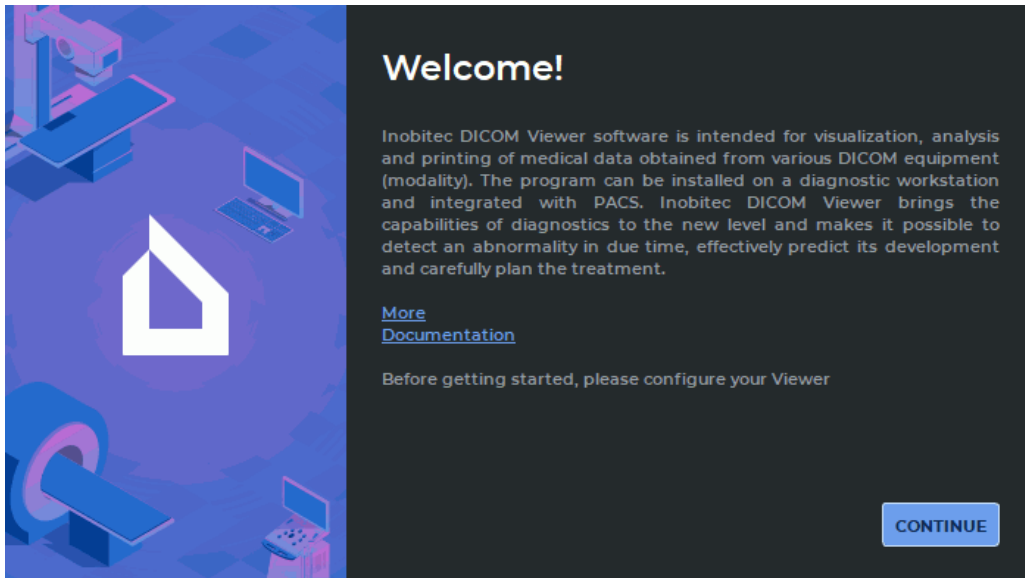

Figure 16: Welcome panel

The following information is displayed in the welcome panel:

- Link **More**. Download page Inobitec DICOM Viewer is available at this link.
- Link **Documentation**. Clicking the link brings up the help system of the DICOM Viewer. If the help system for the current language is not installed, a dialog box is displayed with a warning and a link to online help.

To cancel the DICOM Viewer launch and initialization, press **Esc** on the keyboard. Select **YES** in the dialog box for cancelling initialization and launch (Fig. 17). If you do not want to cancel initialization and launch the DICOM Viewer click the **NO** button.

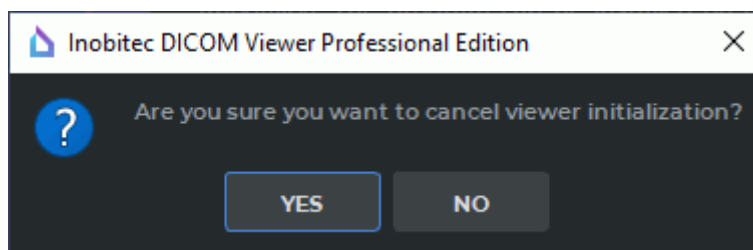

Figure 17: Dialog box for cancelling initialization and launch

To complete initialization and launch of the DICOM Viewer main window, you need to follow all the setting up steps provided in the welcome panel. If the user cancels the DICOM Viewer initialization, the welcome panel will pop up the next time the program is launched.

To go to the next page, click the **CONTINUE** button.

1. On the page **Local Storage** (Fig. 18) change the path to the Local Storage DICOM data. We recommend leaving the default value.



The path to the Local Storage can be changed by the user after initialization of DICOM Viewer. For more information see Section 16.1.

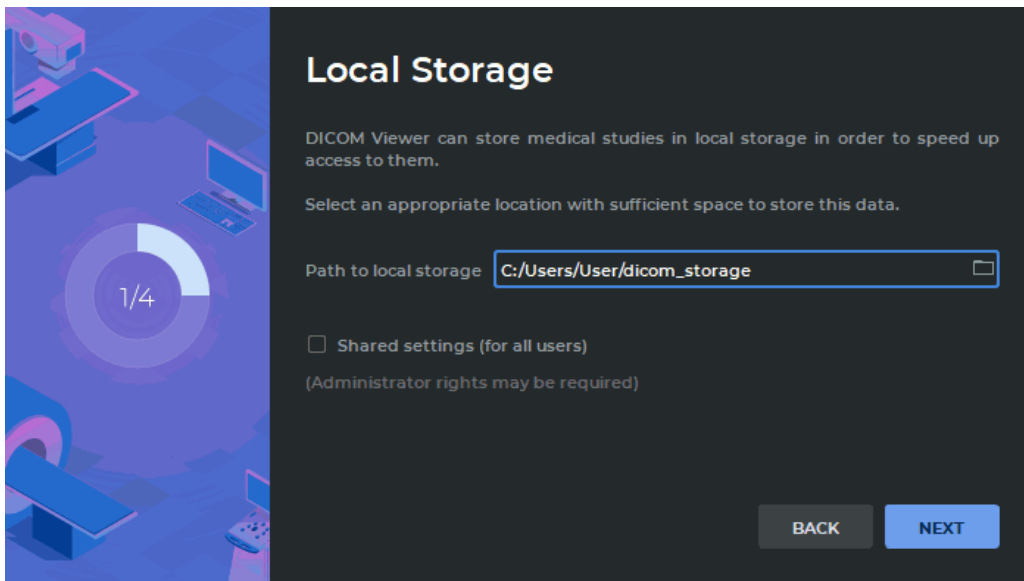

Figure 18: Path to the Local Storage

To make the Local Storage for all the users of this PC, check the **Shared settings (for all users)** box. This mode is disabled by default. It can only be done if the DICOM Viewer was launched by a user with administrator privileges. The users who do not have administrator privileges cannot check or uncheck this box. In this case, an informational message is displayed (Fig. 19).

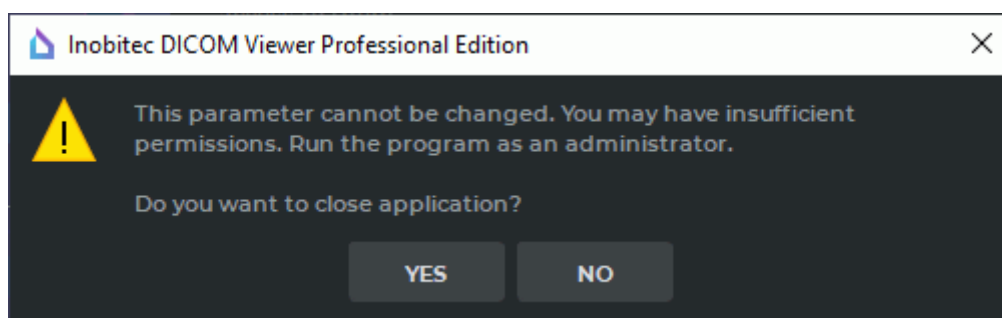

Figure 19: Dialogue warning about lack of administrative privileges

To continue initialization the DICOM Viewer click on the **NO** button. To close the welcome panel without saving parameter values, click on the **YES** button. The DICOM Viewer does not start in this case. The welcome panel will be launched at the next the DICOM Viewer start.

Click on the **Next** button to go to the next page, or **Back** to return to the previous page.

2. On the page **DICOM Listener** (Fig. 20) set the parameters of the DICOM listener service.

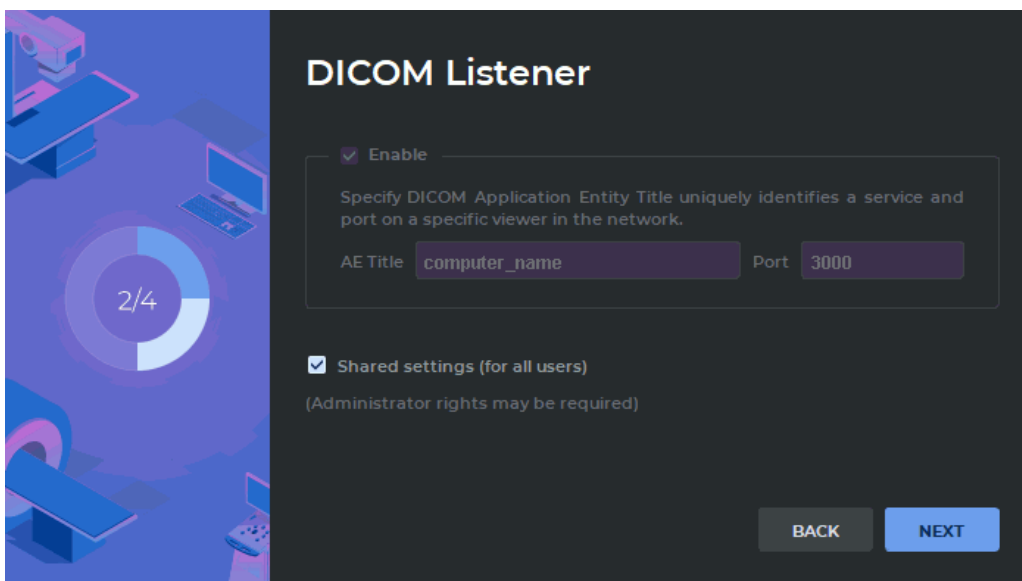

Figure 20: DICOM Service

- Enter the computer name (AE Title) in the field. The length of AE Title value shall not exceed 16 characters. Cyrillic letters and «\» symbols in AE titles are not allowed.
- Enter the port. Default value 3000.

This functionality is described in Section 13.1.1 and can be configured later. If this functionality has already been configured in this computer, then the window shown in Fig. 20 will contain the values specified earlier. Parameters specified earlier for a specific user will not be changed if you install the program for another user or for all users.

To save the current settings for all the users of this PC, check the **Shared settings (for all users)** box. This mode is disabled by default. It can only be done if the DICOM Viewer was launched by a user with administrator privileges. The users who do not have administrator privileges cannot check or uncheck this box. In this case, an informational message is displayed (Fig. 19).

To continue initialization the DICOM Viewer click on the **NO** button. To close the welcome panel without saving parameter values, click on the **YES** button. The DICOM Viewer does not start in this case. The welcome panel will be launched at the next the DICOM Viewer start.

Click the **NEXT** button to go to the next page or the **BACK** button to return to the previous page.

3. Take part in the survey by answering the two questions on the **Survey** pages (Fig. 21 and 22).

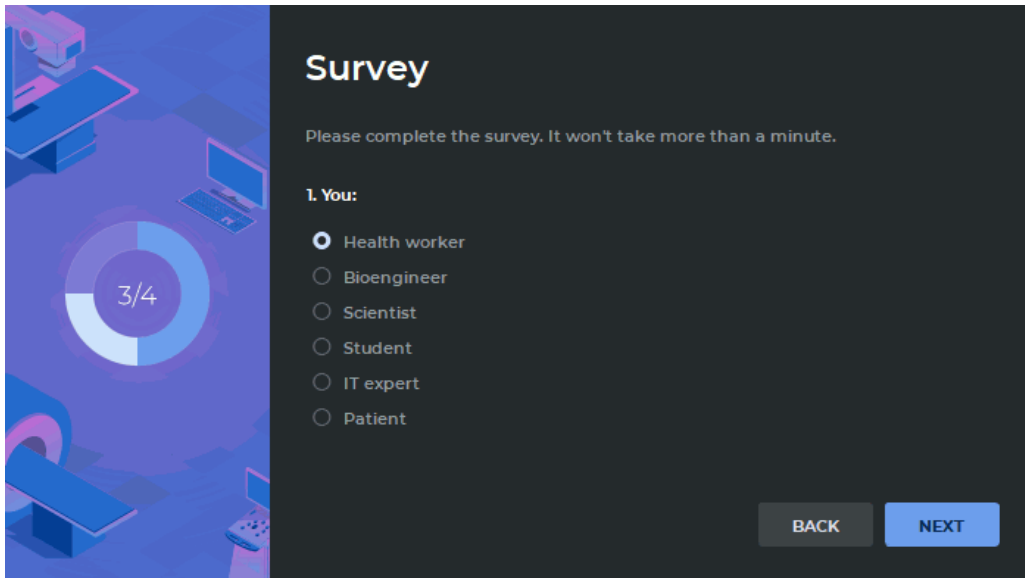

Figure 21: The first survey question

To answer a question, choose one of the options provided by selecting the respective radio button. The **NEXT** button will be activated as soon as the user chooses one of the options. To go to the previous step, click **BACK**.

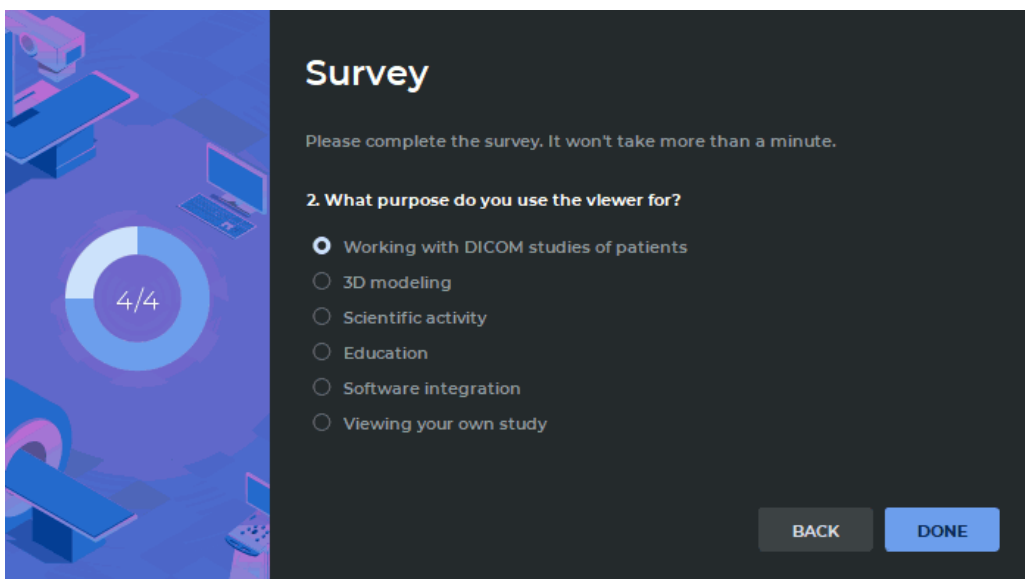

Figure 22: The second survey question

The **DONE** button will be activated as soon as the user chooses one of the options.

Click the **DONE** button, to complete the initialization of the DICOM Viewer, or **BACK** to return to the previous page. If you return to the previous step, the current survey results are saved.

## Launching the Web Viewer

---

Functionality is available in the **Pro** edition

---

To use the Web Viewer, you should enable web access (see Section 13.1.3).

To open the Web Viewer:

1. Open any Web browser.
2. Enter the link in the address bar to access to the Web Viewer. You can see this link in the services settings dialog (see Section 13.1.3). The link looks like *http://youraddress:port*. Replace *youraddress* with the ip address or the computer name on which the DICOM Viewer is installed and replace *port* with the web access port specified in the **Services** dialog.
3. Go to the entered link.
4. Enter the user name and user password specified in the services settings dialog.

---

# Chapter 1

## Program Window Elements

The main application window looks as follows (Fig. 1.1).

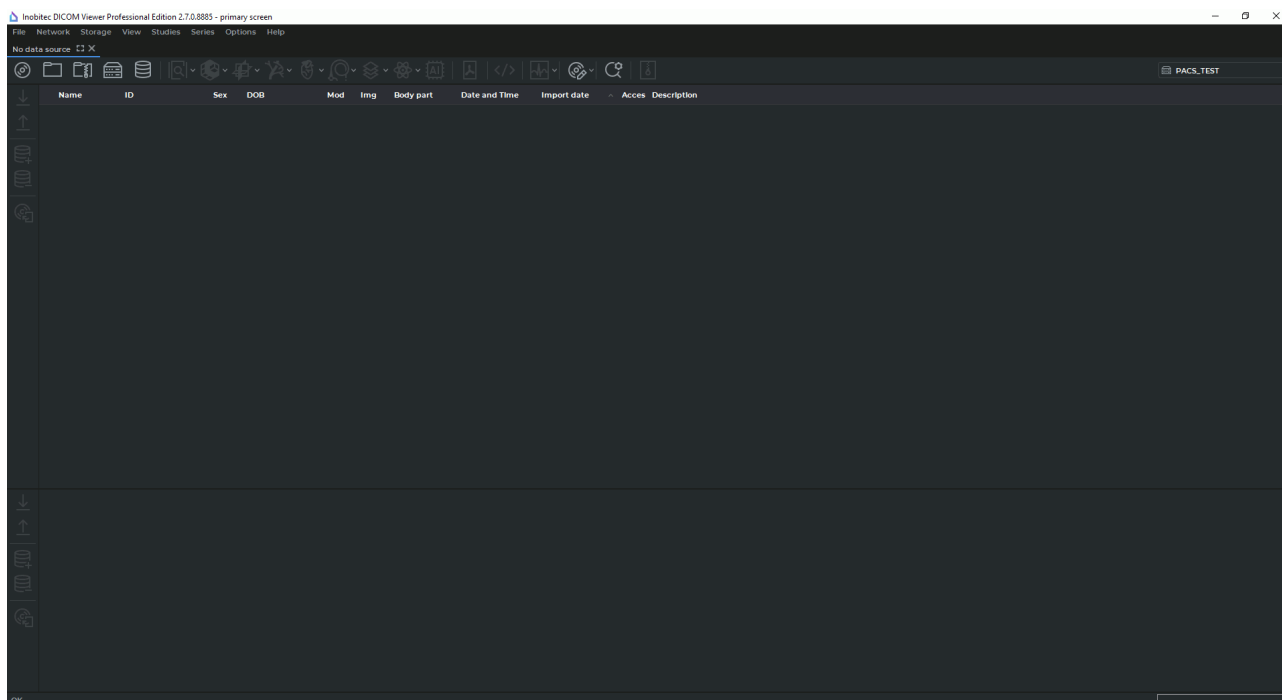

*Figure 1.1: Main application window*

The DICOM Viewer window consists of several elements.

## 1.1 Main Menu

The **Main** menu is shown in Fig. 1.2 (highlighted in red).

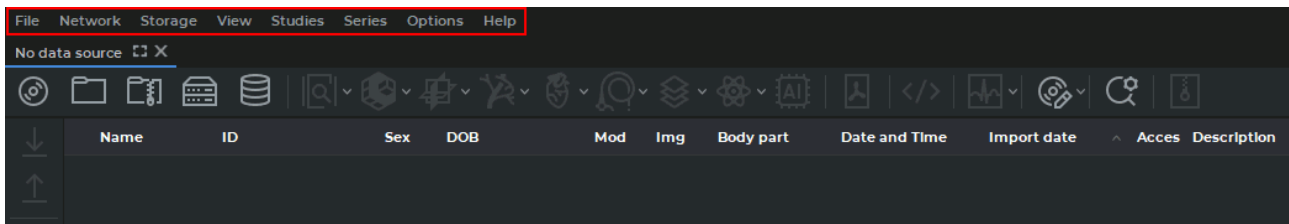

Figure 1.2: Location of the main menu in the DICOM Viewer window

The main menu includes several items.

### 1.1.1 File

The **File** menu item contains the following sub-items:

- **Study list** opens a new tab in the program window;
- **Report template**<sup>PRO</sup> opens a submenu for creating, deleting, and editing a report sample (Chapter 18);
- **Open image annotation results...**<sup>ADD</sup> opens a dialog box for selection of a JSON-file with annotation results that were saved earlier (Chapter 12);
- **Open project...**<sup>ADD</sup> opens a dialog box for selection of a segmentation project or DTI file containing source DICOM data. The project will be opened in the default tab (see Section 6.11.4);
- **Open project as...**<sup>ADD</sup> opens a dialog box for selection of a segmentation project or DTI file containing source DICOM data. This option allows the user to open a part of the project and select the tab where it will be opened (see Section 6.11.4);
- **Preview** opens the image preview tab for printing on paper;
- **DICOM preview** opens the image preview tab for DICOM printing;
- **Page layout** opens the settings for printing on paper;
- **Print** opens the system dialog for printing on paper;
- **Exit** shuts down the program.

## 1.1.2 Network

The **Network** main menu item contains the following sub-items:

- **Network status...;**
- **Servers...;**
- **Services;**
- **DICOM printer setup...**

For details on how to work with the network, see Chapter 13.

The DICOM printer settings are described in Chapter 19.

## 1.1.3 Storage

The **Storage** main menu item contains the following sub-items:

- **Storage status...;**
- **Check storage...;**
- **Clear storage...**

For details on how to work with the storage, see Chapter 14.

## 1.1.4 View

The **View** main menu item contains the following sub-items:

- **Image viewer;**
- **Volume reconstruction;**
- **MPR reconstruction;**
- **Vessel analysis<sup>ADD</sup>;**
- **Coronary artery analysis<sup>ADD</sup>;**
- **Cardiac function analysis<sup>ADD</sup>;**
- **Virtual endoscopy<sup>PRO</sup>;**
- **Series fusion<sup>PRO</sup>;**
- **PET Analysis<sup>ADD</sup>;**
- **Open pdf document;**
- **ECG viewer.**

If a sub-item name is displayed in grey, it means that the command is unavailable for the selected study. If all sub-item names are displayed in grey, it means that no study has been selected from the study panel. Section 1.5 describes how to select studies. Three display modes are available for each sub-item:

- **Show at window 1** opens images in a new tab;
- **Show as detached window** opens images in a separate window;
- **Show fullscreen** opens images in the full screen mode. To exit the full screen mode, press **Esc** or **F11** on the keyboard.

If the DICOM Viewer is set up for working with two displays, and/or if the screen is split, there are up to four options for displaying a tab. The monitor settings are described in Section 16.5.

## 1.1.5 Studies

The **Studies** main menu item contains the following sub-items:

- **Open DICOM CD/DVD...**;
- **Scan DICOM folder...**;
- **Open zip archive...** (see Section 1.5.2);
- **Search**;
- **Download selected studies to Local Storage**;
- **Upload selected studies to remote server**;
- **Add selected studies to Local Storage**;
- **Remove selected studies from Local Storage**;
- **Add the selected studies to DICOM CD/DVD image**;
- **Save studies to folder**;
- **Create anonymized copies of selected studies...** (see Section 17.3);
- **Export study list to CSV...** (see Section:Study Panel);
- **Edit patient name** (see Section 1.9.3);
- **Restore patient name**;
- **Edit description** (see Section 1.9.3);
- **Restore description**.

For details on how to select data source, see Section 1.5. Sub-items **Server search** and **Local storage search** are available for the sub-item **Search**.

For details on how to work with studies, see Section 1.11.



## 1.1.6 Series

The **Series** main menu item contains the following sub-items:

- **Download selected series to Local Storage;**
- **Upload selected series to remote server;**
- **Add selected series to Local Storage;**
- **Remove selected series from Local Storage;**
- **Add selected series to DICOM CD/DVD image;**
- **Save series to folder** (see Section [1.6.2](#));
- **Create uncompressed copy of series** (see Section [1.13](#));
- **Create anonymized copy of series...** (see section [17.3](#));
- **Sort.**

Sub-items **Sort by description**, **Sort by time** and **Sort by series number** are available for the sub-item **Sort**.

For details on how to work with series, see Section [1.11](#).

## 1.1.7 Options

The **Settings** main menu item contains the following sub-items:

- **Settings...;**
- **Export settings...;**
- **Import settings....**

The DICOM Viewer settings are described in Chapter [16](#).

## 1.1.8 Help

The Help menu item contains the following sub-items:

- **Contents...** opens the Help System;
- **License...** opens a window to enter the license key;
- **License from file...** opens a window to load a trial version activation key file;
- **About...** displays a window with the information about the DICOM Viewer.

The Help System is described in Chapter [22](#).

## 1.2 Window Management

To the DICOM Viewer does not shut down but closed to the system tray, when you close it, check the box **Show system tray icon** (see Section 16.3). To restore the main window from the tray, double-click on the tray icon in the system tray or right-click on the tray icon and select the **Restore** item. To shut down the application right-click on the tray icon and select the **Exit** item (Fig. 1.3).

To enable the DICOM Viewer to minimize to the system tray, check the box **Minimize to tray**.

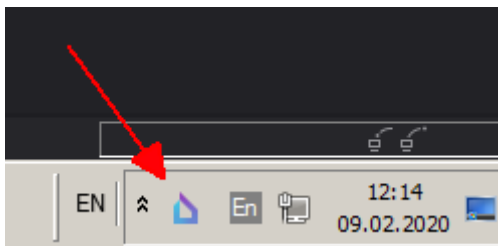

Figure 1.3: System tray icon

When you shut down the DICOM Viewer click **OK** to shut down the DICOM Viewer in the dialog box that appears, or **Cancel** to continue to work with the program. If you want the DICOM Viewer to always shut down without this confirmation, check the box **Don't show this dialog again** and click **OK**. If you want the DICOM Viewer to show the confirmation dialog, check the box **Confirm on exit** (see Section 16.2).

## 1.3 Tab Panel

### 1.3.1 General

A tab is a window fixed in the main program window. You can switch from tab to tab using buttons on the tab panel. The tab panel is highlighted in red in Fig. 1.4.

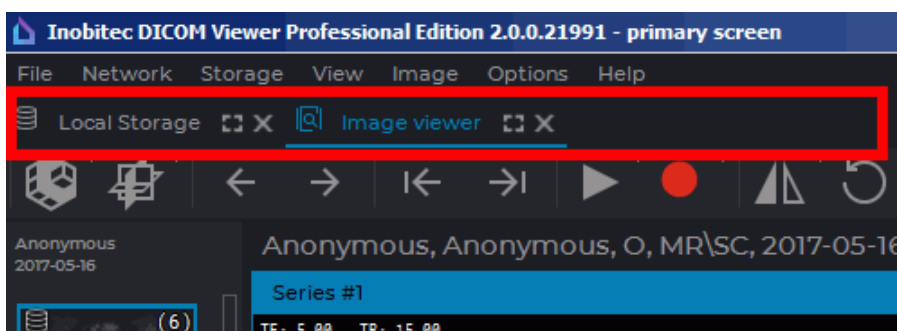

Figure 1.4: Tab panel location in the DICOM Viewer window

Each tab opened in the DICOM Viewer window corresponds to a stub on the panel. To switch to a particular tab, click the corresponding stub (Fig. 1.5). The file path or other information about the tab content is displayed on the tab stub.

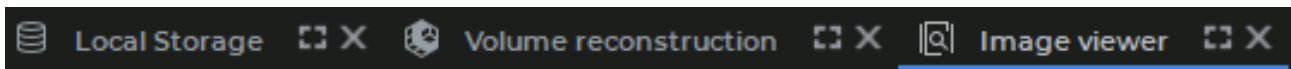

Figure 1.5: Multiple tabs. The Image viewer tab is active

To show the patient's name on the tab stub, enable the **Show patient name in a tab** option in the program settings (see Section 16.2). This option is enabled by default. In the figure, you can see the type of the tab shown only as an icon on the left-hand side of the patient's name (Fig. 1.6).

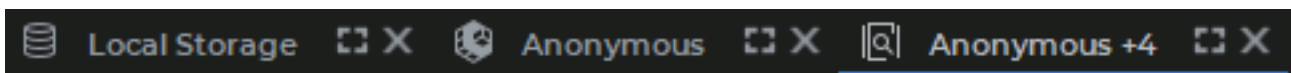

Figure 1.6: Patient names are displayed on the tab stubs. The Image viewer tab is active

If several studies have been opened in the same tab, the patients' names will be separated with «/». If a patient's name is too long, it will be truncated and the «...» sign will be placed at the end, e.g. *Patient name.../ Patient name.../ Patient name...*

If there are fewer than 5 symbols left for each patient's name, then the tab will only show the name of the first patient and the number of the patients' names left, e.g. *Patient name...+4*.

When you place the cursor on the tab stub, a tip with a complete list of the patients' names will pop up.

On the stub of a fused series tab, you will see the name of the patient from the first layer.

### 1.3.2 Manage a Tab

To manage a tab, use the buttons in its top right-hand corner (highlighted in red in Fig. 1.7).

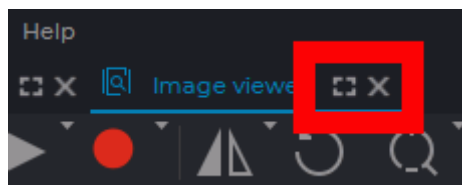



Figure 1.7: Tab management buttons

Tab management buttons:

	The <b>Full screen</b> button displays the tab in the full screen mode. The tab management buttons are unavailable. To exit, press <b>Esc</b> or <b>F11</b> .
	The <b>Separate window</b> button displays the tab in a separate window.

To switch to the full screen mode, you may as well press **F11**, and to go back, you can use **F11** or **Esc**. If the tab is displayed in a separate window, the DICOM Viewer workspace looks as shown in Fig. 1.8.

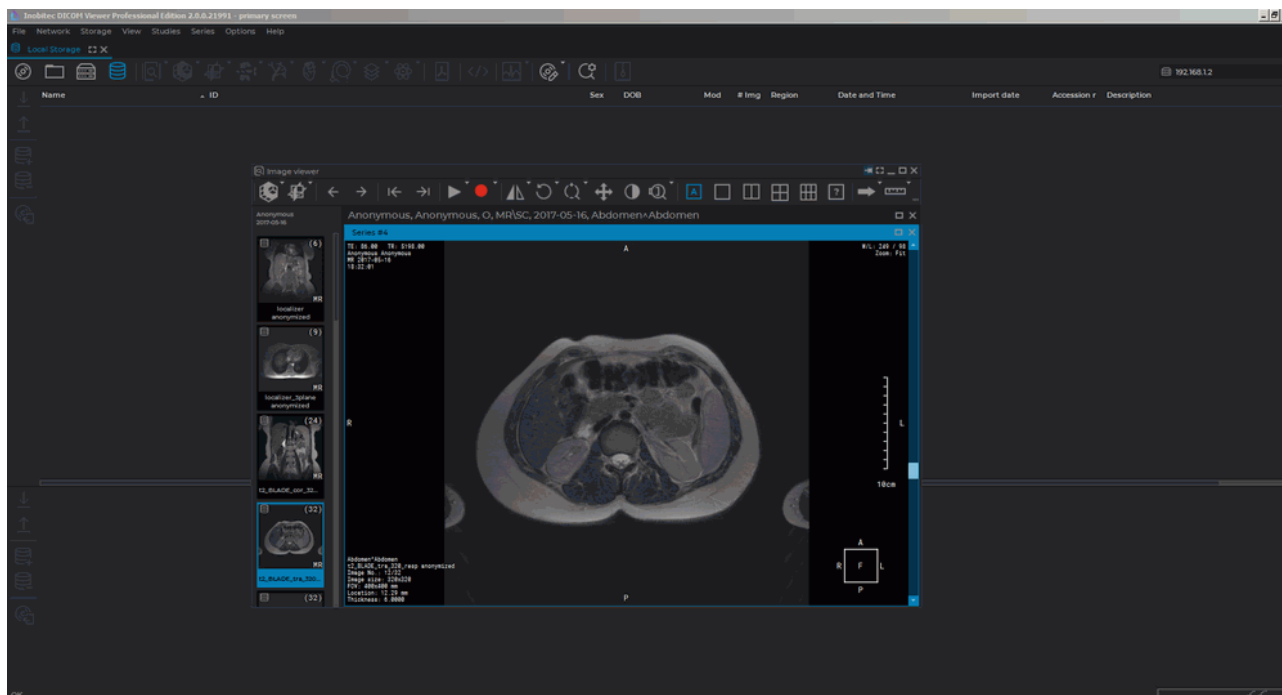





Figure 1.8: A tab opened in a separate window

The window management buttons are located in the top right-hand corner of the window (highlighted in red in Fig. 1.8). Window management buttons:

	The <b>Fix window</b> button embeds the window as a tab in the main DICOM Viewer window.
	The <b>Full screen</b> button displays the window in the full screen mode. The window management buttons are unavailable. To exit the full screen mode, press <b>Esc</b> or <b>F11</b> .
	The <b>Minimize window</b> button reduces the window to an icon located at the bottom of the screen (highlighted in red in Fig. 1.9). The window title is written on the icon.
	The <b>Expand</b> button expands the window to the full screen. Unlike the full screen mode, the window management buttons will be available.

✕	The <b>Close</b> button closes the window.
☐	The <b>Restore down</b> button restores the initial window size.

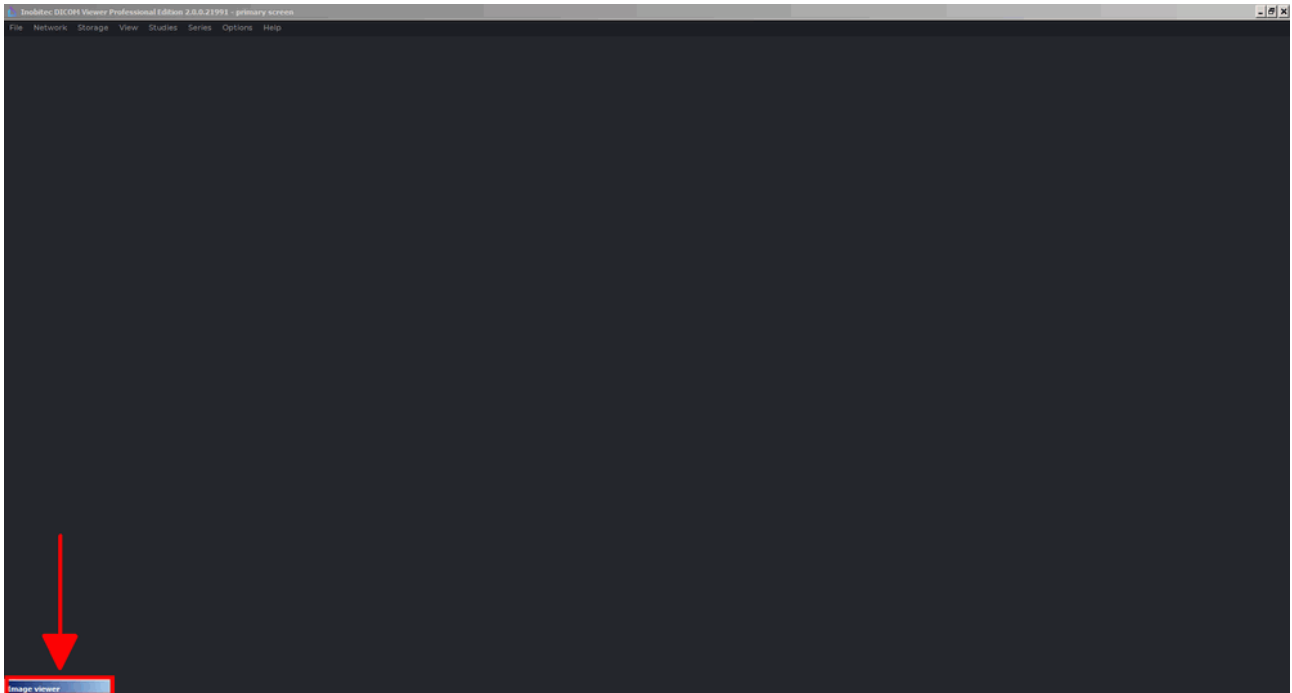

Figure 1.9: Window reduced to an icon

To unfold a window from an icon, double-click the left mouse button on the icon.

## 1.4 Toolbar

The **Toolbar** is shown in Fig. 1.10 (highlighted in red).

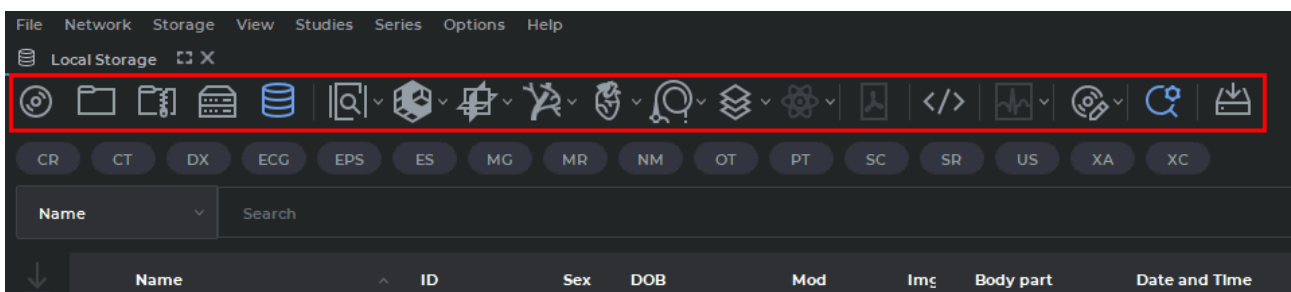







Figure 1.10: Toolbar location in the DICOM Viewer window











Data source selection buttons on the toolbar:



	The <b>Open DICOM CD/DVD, which contains DICOMDIR metafile</b> button sets a CD or DVD as the source of DICOM data and opens the folder selection dialog.
	The <b>Scan a folder for DICOM data</b> button sets a folder as the DICOM data source and opens the folder selection dialog.
	The <b>Open a zip archive with DICOM data</b> button provides a folder with zipped studies as the DICOM data source and opens the folder selection dialog.
	The <b>Search data on the remote PACS Server</b> button sets a PACS server as the DICOM data source and opens the search panel.
	The <b>Search data in the Local Storage</b> button sets a local storage as the DICOM data source and opens the search panel.

For details on how to work with the search panel, see Section 1.7.

The button corresponding to the selected data source is displayed on a light background.

Image view buttons on the toolbar:

	The <b>Image viewer</b> button opens images in the flat image view window.
	The <b>Volume reconstruction</b> button opens images in the volume reconstruction window.
	The <b>MPR Reconstruction</b> button opens images in the multiplanar reconstruction window.
	The <b>Vessel analysis</b> opens images in the Vessel Analysis window <sup>ADD</sup> .
	The <b>Coronary artery analysis</b> opens images in the Coronary Artery Analysis window <sup>ADD</sup> .
	The <b>Cardiac function analysis</b> opens images in the Cardiac Function Analysis window <sup>ADD</sup> .
	The <b>Virtual endoscopy</b> button opens images in the virtual endoscopy window <sup>PRO</sup> .
	The <b>Series fusion</b> button opens images in the series fusion window <sup>PRO</sup> .
	The <b>PET analysis</b> button opens images in the PET Analysis window <sup>ADD</sup> .
	The <b>Show image tags</b> button opens DICOM tags for the selected series of the selected study (see Section 17).

	The <b>Open pdf document</b> button opens the pdf document contained in the study in the default pdf viewer.
	The <b>ECG Viewer</b> button opens images in the ECG view window.

If the action corresponding to a button is not available, the button looks pale and cannot be pressed (inactive).

All the buttons in this group are made up of two parts (Fig. 1.11).



Figure 1.11: Button with location options

If you click on the arrow (right side of the button highlighted in green), a menu with options for displaying the information on the screen will pop up.

- **display at monitor1** opens images in a new tab;
- **show as detached window** opens images in a separate window;
- **show fullscreen** opens images in the full screen mode.

To open an image in a new tab, click on the button (highlighted in red).



The DICOM Viewer provides an opportunity to open selected series in various tabs with certain key combinations. Hotkeys have been assigned by default to the most popular tabs (the key combinations are provided in parenthesis):

- **Image viewer** (Alt + I);
- **MPR reconstruction** (Alt + M);
- **Volume reconstruction** (Alt + D);
- **Vessel analysis** (Alt + V);
- **Coronary artery analysis** (Alt + C).

You can change a hotkey combination or assign new hotkeys to other tabs in the **Tabs** section of the **Hotkeys** settings (see Section 16.8).

A series may be opened with the help of a key combination from the list of studies or from another tab where the respective buttons are provided.

	The <b>DICOM CD/DVD Creator</b> button opens the creator for disks containing DICOM data. The disk write is described in Chapter 15.
---	--



	The <b>Advanced search</b> button opens the advanced search panel at the top of the tab. To hide the panel, click the button again. If the search panel is open, the search button will be displayed against a light background. For details on how to work with the search panel, see the next section.
	The <b>Save studies list to the folder</b> button allows you to save the selected studies to the specified folder. This function is available as well from the study context menu. For details on how to save studies see Section 1.6.1

## 1.5 Select Data Source

If the DICOM data contains text in national coding that does not match the coding of the main data, then a meaningless sequence of characters in the names of studies, series, etc may be displayed. In this case, to display the text correctly, you must select the target encoding in the settings (see Section 16.4). By default, the encoding of the data source is set. It is the one that is specified in the DICOM files.

### 1.5.1 Select a CD, DVD or Local Folder as the Data Source

To open studies stored on a CD, DVD or in a local folder:

1. Select a CD or DVD as the data source by clicking the  button on the toolbar, or a local folder by clicking on the  button. Commands **Open DICOM CD/DVD...** and **Scan DICOM folder...** are available as well from the **Studies** menu.
2. In the window that appears, select the folder containing the images, and click **Select**. To cancel the action, click **Cancel**.

The studies stored in the selected location will be displayed on the study panel.

The studies being transferred from the local folder  may be opened in the **Image viewer**, **ECG viewer**, and **DICOM tag viewer** tabs before all the files have been read. PDF documents are also available to work with.

You will be able to open studies in other tabs, save them, record or send to the server after all the study directories have been read. If there are several series in a folder with a study, a complete list of such series will be displayed only after all the files have been read.

The process of uploading studies from a local folder is reflected on the information panel in the form of a progress bar. If you close the tab before the files have been read, the process of reading files is stopped.



**Attention! If you switch to a different data source and then return to the current one, the study list will be cleared.**



## 1.5.2 Opening Zipped DICOM Studies

The DICOM Viewer provides an opportunity to open and view zipped studies.

To open a zipped study from a local folder, proceed as follows:

1. Choose a local folder with zipped files as the data source by pressing the  **Open a zip archive with DICOM data** button on the toolbar. Command **Open zip archive...»** is also available from the **Studies** menu.
2. Choose one or several archives in the box that pops up and click **Open**. Click **Cancel** to cancel.

The studies stored in the selected location will be displayed on the study panel.

The work with zipped studies is performed in the same way as the work with the studies from a local storage.

The thumbnails for the series from ZIP archives are provided with  pictograms. Damaged ZIP archives and damaged files from ZIP archives are ignored by the DICOM Viewer.

If an encrypted ZIP archive is opened, a dialog box (see Fig. 1.12) pops up. Enter the password and click **OK** to open the encrypted ZIP archive or **Cancel** to cancel.

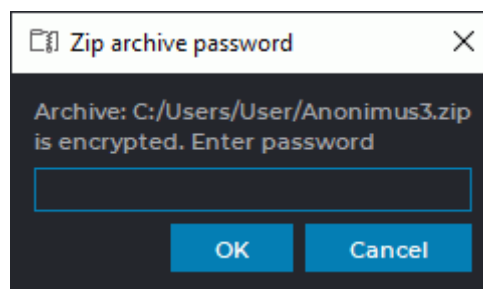

Figure 1.12: Entering the ZIP archive password dialog box



**Attention!** If you switch to a different data source and then return to the current one, the study list will be cleared.

## 1.5.3 Opening DICOM studies by dragging and dropping

You can open DICOM studies in several ways:

1. **Dragging and dropping studies on the DICOM Viewer shortcut.** Drag and drop one or more folders with DICOM studies or ZIP archives from the explorer window to the DICOM Viewer shortcut (this option is only available on Windows and macOS). The list of studies will be opened in a new tab **DICOM data in the folder** or **DICOM data in the zip archive**. Besides, the **Image viewer** tab with the first series of the first study will be opened.

The opportunity to drag and drop both, ZIP archives and unzipped data folders with DICOM data, to the DICOM Viewer shortcut is supported. In this case, the study lists are opened in new tabs **DICOM data in the zip archive** and **DICOM data in the folder**. New **Image viewer** tabs with the first series of the first studies from each list will be opened.



If the **DICOM Viewer** has already been launched, then studies from a folder will be opened in the currently running program regardless of the version and the edition of the program chosen by the user (see Section **Launch multiple instances of the program**).

2. **Dragging and dropping studies to the DICOM Viewer study list.** Drag and drop one or more folders with DICOM studies or ZIP archives from the explorer window to the DICOM Viewer study list. The list of studies will be opened in a new tab **DICOM data in the folder** or **DICOM data in the zip archive**. Besides, the **Image viewer** tab with the first series of the first study will be opened.

Dragging and dropping of ZIP archives and unzipped data folders with DICOM data to the DICOM Viewer study list is supported. In this case, the study lists are opened in new tabs **DICOM data in the zip archive** and **DICOM data in the folder**. New **Image viewer** tabs with the first series of the first studies from each list will be opened.

3. **Dragging and dropping studies to the Image viewer window of the DICOM Viewer.** Drag and drop one or more folders with DICOM studies or ZIP archives from the explorer window to the **Image viewer** window of the DICOM Viewer. The study and its series are added to the series panel. The first series of the study will be opened in a new **Image viewer** window.

Dragging and dropping of ZIP archives and unzipped data folders with DICOM data to the **Image viewer** window of the DICOM Viewer is supported. Studies and their series are added to the series panel. The first series of the study will be opened in a new **Image viewer** window.

4. **Dragging and dropping studies on the Image viewer tab stub of the DICOM Viewer.** Drag and drop one or more folders with DICOM studies or ZIP archives from the explorer window on the **Image viewer** tab stub of the DICOM Viewer. The study and its series are added to the series panel. The first series of the study will be opened in a new **Image viewer** window.

Dragging and dropping both, ZIP archives and unzipped data folders with DICOM data to the **Image viewer** tab stub of the DICOM Viewer is supported. Studies and their series are added to the series panel. The first series of the studies will be opened in a new **Image viewer** window.

#### 1.5.4 Opening DICOM studies from the context menu



This function is only available on Windows.

On Windows, DICOM studies can be opened in the DICOM Viewer via the explorer context menu. To do that, you have to enable the **Launch the viewer from the context menu** option in the **Extended parameters** window when installing the DICOM Viewer (see Fig. 7). To change this setting, go to the **Behavior** section of the DICOM Viewer configuration window (see Section 16.3).

To open a study via the explorer context menu, proceed as follows:

1. Open the Explorer window and choose the folder with the study.

2. Right-click on the selected folder and choose the **Open with Inobitec DICOM Viewer <Edition> <Version>** option on the context menu.



**If several DICOM Viewer versions or editions were installed on the same operating system, then on the context menu, you will see several options for launching the required program version or edition.**

The list of studies from the folder will be opened in a new **DICOM data in the folder** tab, and the first series of the first study on the list will be opened in a new **Image viewer** tab.



If the DICOM Viewer has already been launched, the list of studies and the first series of the first study will be opened in new tabs of the currently running program.

If the DICOM Viewer has already been launched and minimized to the system tray, it is activated (see Section 1.2).

To open a study in a different program version or edition via the explorer context menu, you need to shut down the running program first (see **Launch multiple instances of the program**).

### 1.5.5 Select a PACS Server or Local Storage as the Data Source

To open studies stored on a PACS server or in a local storage:

1. Select the PACS server as the data source by clicking the **Search data at remote PACS server**  button on the toolbar, or the local storage by clicking **Search data in the local storage** . These commands are available as well from the **Study** context menu.
2. Search for data using the search panel that opens. For details on how to work with the search panel, see Section 1.7. The studies that satisfy the search criteria will be displayed on the study panel. The series panel will display the series of the first retrieved study.



**Attention! If you switch to a different data source and then return to the current one, the study list will be cleared.**

To automatically open a Local Storage when you start the DICOM Viewer check this option (Section 16.7.2) and set up a default search period.

If you open a study from the PACS server, it will be downloaded to the Local Storage. When you close this study the message like **1 series have been downloaded automatically from server. Would you like to keep them on your local storage?** will be displayed. To keep the study in the Local Storage, click **Yes**, to remove, click **No**. If you want to always perform the selected action, check the box **Remember my choice and do not show this dialog again**. For details on how to change your choice, see Section 16.7.2.

For the study, added to the Local Storage at least partially, the import date is displayed on the Study Panel.

When the DICOM Viewer is used as the PACS server, data from remote devices are added to the local storage. Data transfer may be initiated by a transmitting device, such as a CAT scanner, DICOM Server, or DICOM Viewer installed on another computer.

The list of the studies in the local storage is automatically updated each time data are received from a supported source.

New studies that were transferred to the local storage from other sources are marked on the study list with . This icon will be deleted after the new study is selected or after a

search is performed (i.e. the **SEARCH** button on the search panel is clicked). The new studies that were received from third-party devices but do not comply with the search parameters will not be shown on the study list (for details see Section 1.7).

## 1.6 Save Studies and Series to the folder

### 1.6.1 Save Studies to the folder

The DICOM Viewer allows you to save one or more studies from the Local Storage, from a folder, from a Compact Disk or from a PACS Server to a folder.



**Attention! Saving studies from a PACS server in C-MOVE mode is not possible. To do it, connect to PACS Server using C-GET mode or first download the studies to the Local Storage and save them to a folder from the Local Storage.**

When you try to save studies from the server in c-move, the error «**Unsupported server mode**» appears.

The PACS Server connection settings are described in Section 13.2.

If you compress data, then the studies are saved to a zip file.

To save studies:

1. Select data source (Local Storage, Folder, Compact Disk, PACS Server to which the DICOM Viewer is connected in C-GET mode). For details on how to select data source, see Section 1.5.
2. Search for data using the search panel that opens. For details on how to work with the search panel, see Section 1.7. The studies that satisfy the search criteria will be displayed on the study panel.
3. Select one or more studies on the Study Panel. For details on how to work with the Study Panel, see Section 1.9.
4. Click the  **Save studies to the folder** button.
5. In the dialog that opens (Fig. 1.13) set up the following parameters:
  - **Path to save:** path to the folder to save studies;
  - **Folder name (File name):** if only one study is selected for saving, this parameter is editable. Otherwise the DICOM Viewer generates a folder name (archive file name) and the **Folder name (File name)** field is empty. If an archive file with the same name already exists, the DICOM Viewer offers to overwrite it;
  - the **Compress files** check box: if set, the saved data is compressed into a zip archive;
  - if several studies are selected, then the **Save each study into separate folder (file)** check box appears. It allows to save each study into separate folder (archive file);
  - the **Anonymize** check box allows to anonymize saving data. For details, see Section 17.3;

- The **Add file extension «.dcm»** box provides an opportunity to save all the data files with *.dcm* extension. The box is unchecked by default. When files with *.dcm* extension are saved, a special DICOMDIR file is not created;
  - to restore default settings, click the **DEFAULTS** button.
6. Click the **OK** button to save or **CANCEL** to cancel.

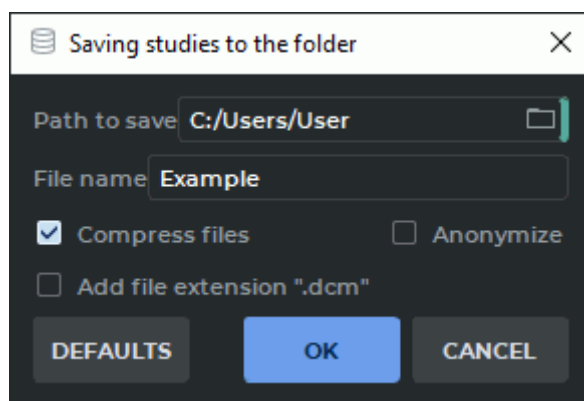

Figure 1.13: Saving studies to the folder dialog

The data saved into the folder is supplied for later recording onto a Compact Disk using the operating system. The Compact Disk opens in the same way as if it were recorded using the DICOM Viewer (without adding the Inobitec DICOM Disc Viewer to the disk image).

## 1.6.2 Save Series to the folder

The DICOM Viewer allows you to save one or more series of a single study from the Local Storage, from a folder, from a Compact Disk or from a PACS Server to a folder.



**Attention! Saving DICOM data from a PACS server in C-MOVE mode is not possible. To do it, connect to PACS Server using C-GET mode or first download the studies to the Local Storage and save them to a folder from the Local Storage.**

When you try to save studies from the server in c-move, the error «**Unsupported server mode**» appears.

The PACS Server connection settings are described in Section 13.2.

To save series:

1. Select data source (Local Storage, Folder, Compact Disk, PACS Server to which the DICOM Viewer is connected in C-GET mode). For details on how to select data source, see Section 1.5.
2. Search for data using the search panel that opens. For details on how to work with the search panel, see Section 1.7. The studies that satisfy the search criteria will be displayed on the study panel.
3. Select a study on the Study Panel. For details on how to work with the Study Panel, see Section 1.9.

4. Select one or more series on the Series Panel. For details on how to work with the Study Panel, see Section 1.10.



**Fused series cannot be saved in a folder.**

5. Select the **Save series to folder** option in the **Series** section of the main menu. If among the selected series there are no series that can be saved in a folder, the **Save series to folder** button will be unavailable. If there is such a series among the selected series, the **Save series to folder** button will be available. When series are saved in a folder, the fused series will be skipped.
6. In the **Saving series to the folder** dialog box that pops up, provide the required parameters. The interface of the dialog box is identical with the interface of the dialog box for saving studies to a folder (see Fig. 1.13).
7. Click the **OK** button to save or **CANCEL** to cancel.

The series saved in a folder can be viewed and then recorded on a CD with the OS software.

## 1.7 Search Panel

The search panel is shown in Fig. 1.14.

To open or close the panel, click the  button on the toolbar.

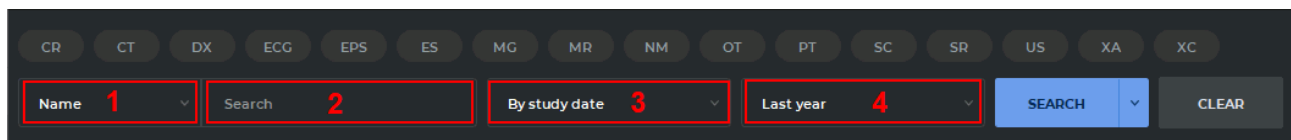

Figure 1.14: Search panel

A search query is executed in the text field (see «2» in Fig. 1.14). From the drop-down list («1» in Fig. 1.14), select one of the following search parameters:

- **patient name** (to search for a name that does not start with the entered characters, put an asterisk at the beginning: «\*John»);
- **patient ID** (similar to search by name);
- **body part** (Enter the name of a body part in the text field. Under the text field, you will see some options that may be used for searching by body parts);
- **accession number** (similar to search by name);
- **description.**

To search for studies by modality, press the button for the respective modality. The buttons for the selected modalities are highlighted. You can choose any modalities combination. To delete a selected modality, press the button again.

The search panel also provides for search by date of birth, search by the date of study performance or study import. Select one of the following options from the drop-down list (see «3» in Fig. 1.14):

- **by study date;**
- **by import date;**
- **by date of birth.** In the search period drop-down list (see «4» in Fig. 1.14) only the *Exact date* option is available.

You can perform search by the exact date, by the time interval specified or by the period selected from the drop-down list. Choose a period from the drop-down list (see «4» in Fig. 1.14):

- **all time;**
- **today;**
- **yesterday;**
- **last week;**
- **last month;**
- **last year;**
- **exact date;**
- **interval.**

To search by date and interval enter the year: YYYY-\*\*-\*\*, year and month: YYYY-MM-\*\*, or the full date. The date can also be selected using the calendar.

After filling in the required fields, click the **SEARCH** button or press the **Enter** key on the keyboard. If the **SEARCH** button is inactive, it means that the selected data source is not available. To clear the search criteria, click **CLEAR**.

The search for studies on the PACS server with no period specified (option **All time**) may take some time and increase the server load. Therefore, when you click the **SEARCH** button, the warning dialog **Search for all time. It may take some time. Would you like to continue?** will be displayed. To perform a search, click **Yes**, to cancel, click **No**.

If four or more characters are entered in the search field, the long search on the PACS server warning message is not displayed, regardless of the specified search date.

The PACS Server may not support the search by some of the selected options and criteria.

### 1.7.1 Saving the Search Parameters

To simplify study search by commonly used parameters, the DICOM Viewer provides for an opportunity to save study search parameters (presets).

To create a new preset with commonly used parameters, proceed as follows:

1. Open the search panel and specify the search parameters (for details see Section 1.7).

2. Click the arrow on the right-hand side of the **SEARCH** button and select **Save preset**.
3. In the **Preset creation** dialog box (Fig. 1.15), enter the name of the new preset.

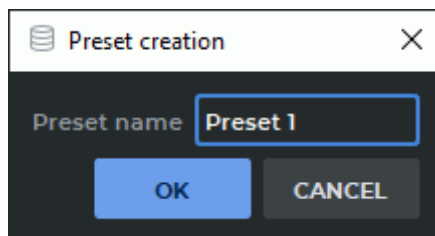

Figure 1.15: The Preset creation dialog box

Click **OK**, to create new preset, or **CANCEL** to cancel.

All the current search panel parameters will be saved as the preset.

To delete a preset, click the arrow on the right-hand side of the **SEARCH** button. Choose the **Remove preset** option and select the preset to be deleted.

## 1.7.2 Searching for Studies by Preset Parameters

To search for studies by preset parameters, choose the preset you need in the **SEARCH** button menu. The search will be performed automatically after you have selected the preset.

The current preset parameters are displayed on the search panel. The preset parameters are specified with consideration for the storage selected. For example, if the search is performed in a storage different from the local storage, it will be impossible to search by the date of import. In this case, a warning will pop up (Fig. 1.16). The search panel does not display the current preset parameters and the search will not be performed.

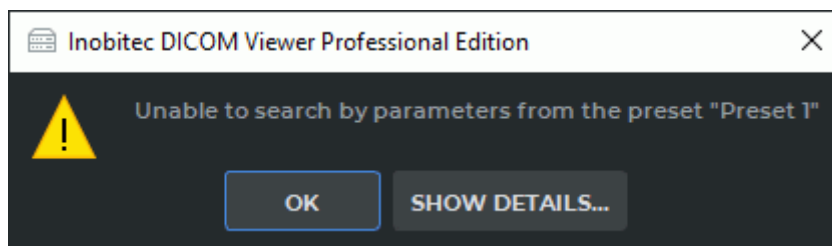

Figure 1.16: Warning that a search cannot be performed



## 1.8 Select Server Panel

The server selection panel is shown in Fig. 1.17.

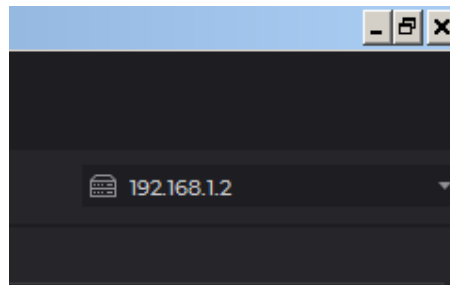

Figure 1.17: Server selection panel in the DICOM Viewer window

The server selection panel specifies the server on which the search for data is carried out.

## 1.9 Study Panel

The study panel is shown in Fig. 1.18 (highlighted in red).

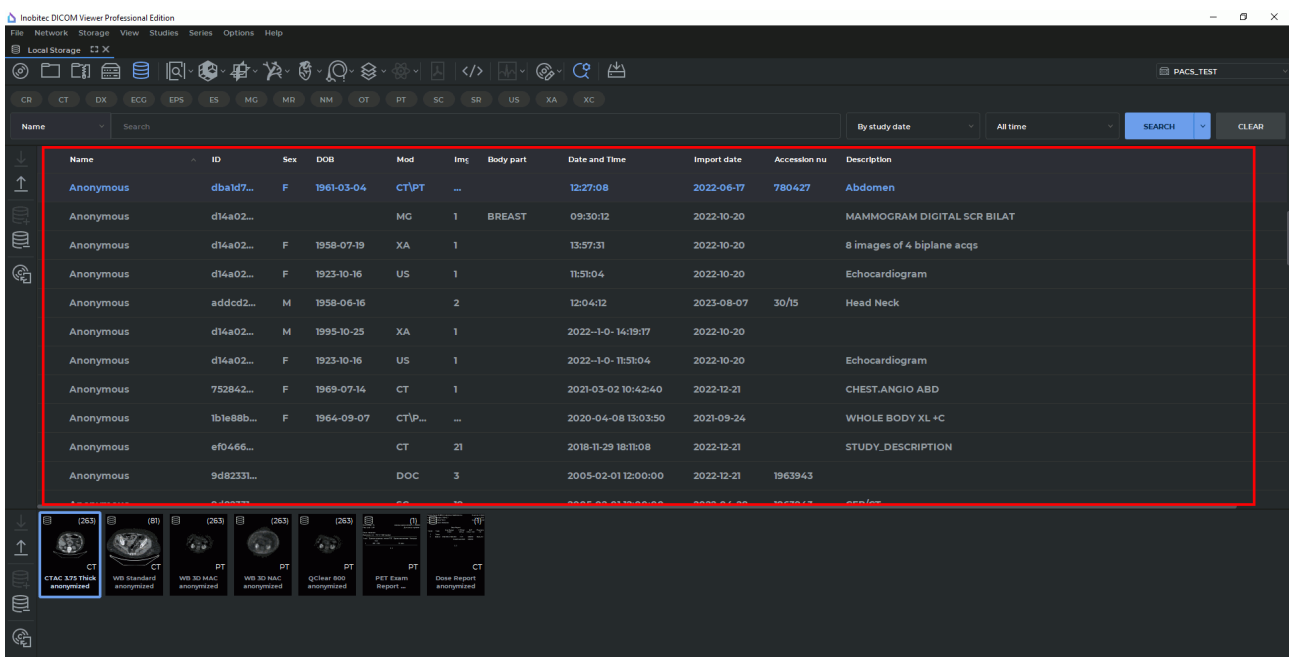

Figure 1.18: Study panel in the DICOM Viewer window

The study panel displays the list of studies stored in the selected location (folder, disk, local storage or PACS server).

To select multiple studies that are contiguous (next to each other):

1. click on one study and then holding **Shift** click the last study or
2. move the cursor from one study to the last study holding the left mouse button.

To select multiple studies that are anywhere on the study list, click on each one holding the **Ctrl** button.

### 1.9.1 Customize Study Panel

The DICOM Viewer allows you to customize columns and the font for the list of studies.

To select columns, right-click on the table header, a menu with a list of columns will be displayed (Fig. 1.19). The displayed columns are marked with a flag. To check/uncheck a column, left-click on its name on the context menu.

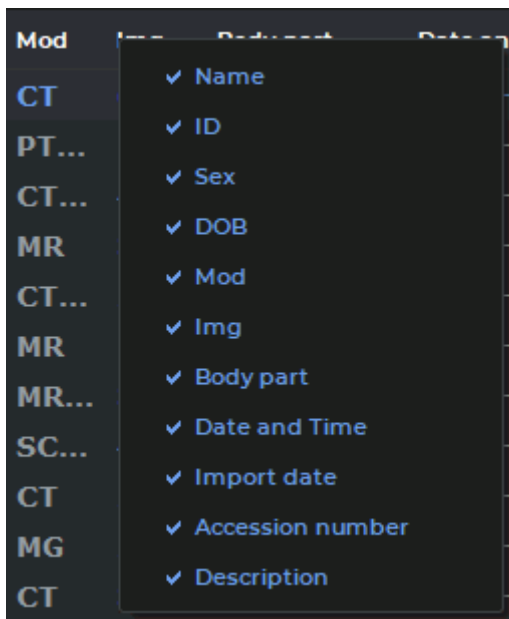

Figure 1.19: Context menu

Set size, family and font style to bold and/or italic (see Section 16.7.2).

### 1.9.2 Sort Studies

If two or more studies are displayed, they can be sorted by a certain parameter. To do this, click on the header of the column the parameter is located in. For instance, to sort by date and time, click on the area highlighted in red in Fig. 1.20.

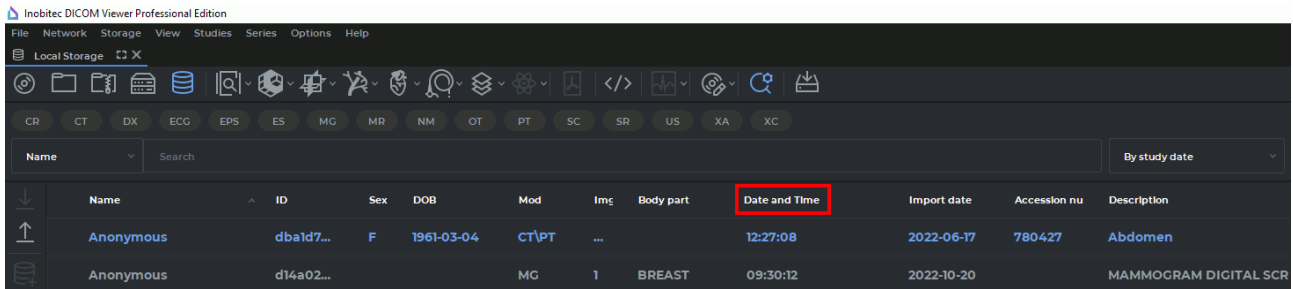



Figure 1.20: Date and time column header

Next to the column name, there is an arrow showing the sorting order (down arrow — descending  , up arrow — ascending  ). To change the sorting order, click on the column header again. Studies can be sorted only by one parameter at a time. The default sorting order is ascending.

### 1.9.3 Edit Patient Name and Description in a Study

Editing the displayed patient name the description for this study are possible only for the studies in the Local Storage or for those that are opened from a folder or from a CD. The data itself will remain unchanged, and this information will not be saved on the PACS server. By default, editing is disabled. To enable it, check the box **Allow to edit patient name and discription** (Section 16.7.2).



**If you change the patient's name, another patient's study may be mistakenly used for establishing a diagnosis.**

To edit the patient name or study description:

1. Right-click on the study on the study panel. The context menu shown in Fig. 1.21 will pop up.
2. Select one of the menu items **Edit Patient Name** and **Edit Description**. The corresponding field will become available for editing, and the cursor will be located in it.
3. Edit the text.
4. Press **Enter** key on the keyboard or click the mouse in the DICOM Viewer window in any area except the edited text to apply the changes.

These commands are available as well from the **Study** context menu.

The commands from the context menu (Fig. 1.22) are available during editing. To open the context menu, right-click on the edited text.

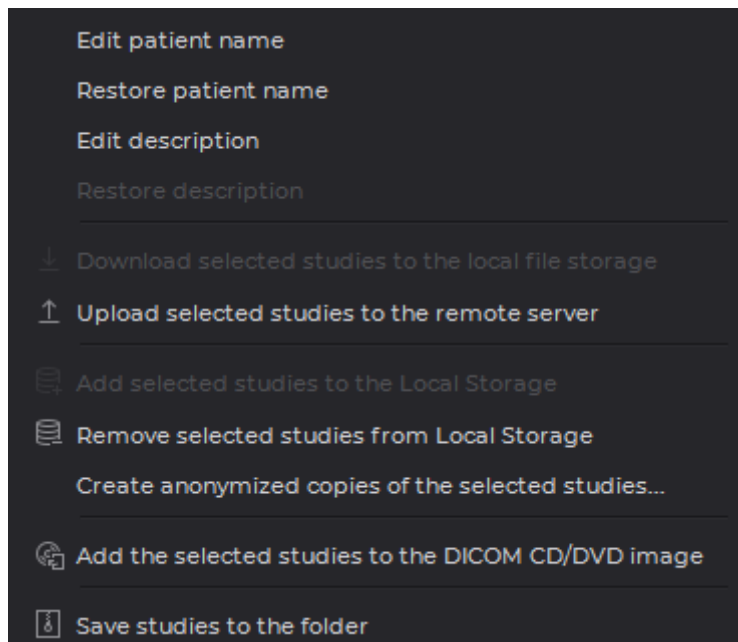

Figure 1.21: Study context menu

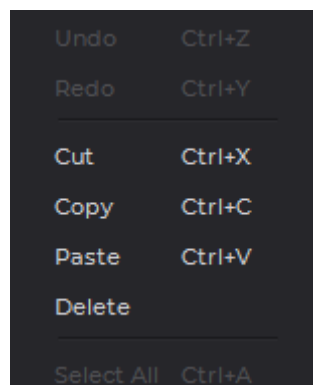

Figure 1.22: Context menu to select editing action

The following commands are available:

- **Undo:** undo the changes;
- **Redo:** redo the last canceled action;
- **Cut:** delete the selected text and copy it to the exchange buffer;
- **Copy:** copy the selected text to the exchange buffer;
- **Paste:** paste the text from the exchange buffer;
- **Delete:** delete the selected text;
- **Select all:** select all edited text.

To restore a patient name or description, right-click on the study and select the **Restore patient name** or **Restore description** item.

If a command is unavailable, it is displayed in grey in the menu.

The edited patient name and description are displayed in italics after you select it on the Study Panel.

### 1.9.4 Study List Export

To save the list of studies displayed in the Study Panel to a CSV file:

1. Select the **Studies** menu and the **Export study list to CSV...** item.
2. In the dialog (Fig. 1.23) that opens, check columns from which you want to export data and click **OK** to confirm or **CANCEL** to cancel.
3. In the dialog that opens choose the folder and file name. Click **Save** to save data or **Cancel** to cancel.

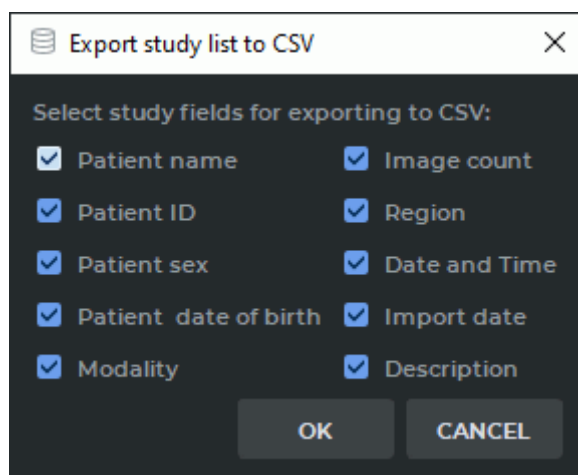

Figure 1.23: The dialog box for selecting fields for export to a CSV file

A study list file in CSV format is a text file with a table. The columns of the table are separated by commas. The file may be opened in any text editor.

The software intended for working with spreadsheets (Microsoft Excel, LibreOffice Calc etc.) is better suited for viewing and analyzing CSV files data.

To open a CSV file in a spreadsheet application undistorted, proceed as follows (as exemplified by LibreOffice Calc):

1. Run the spreadsheet application.
2. In the dialog box for opening a document, select the CSV file and click **Open**.
3. In the **Text Import** dialog box, provide the following parameters:
  - in the **Separator options** section, select the field separator. In our case, it is a comma;

- in the **Fields** section, highlight all the columns in the imported data view window and select the text column type from the dropdown list.

4. Click **OK** to open the document or **Cancel** to cancel.

## 1.10 Series Panel

The panel is shown in Fig. 1.24 (highlighted in red). Select the study from the study panel to see the list of series for it. The first series is highlighted automatically.

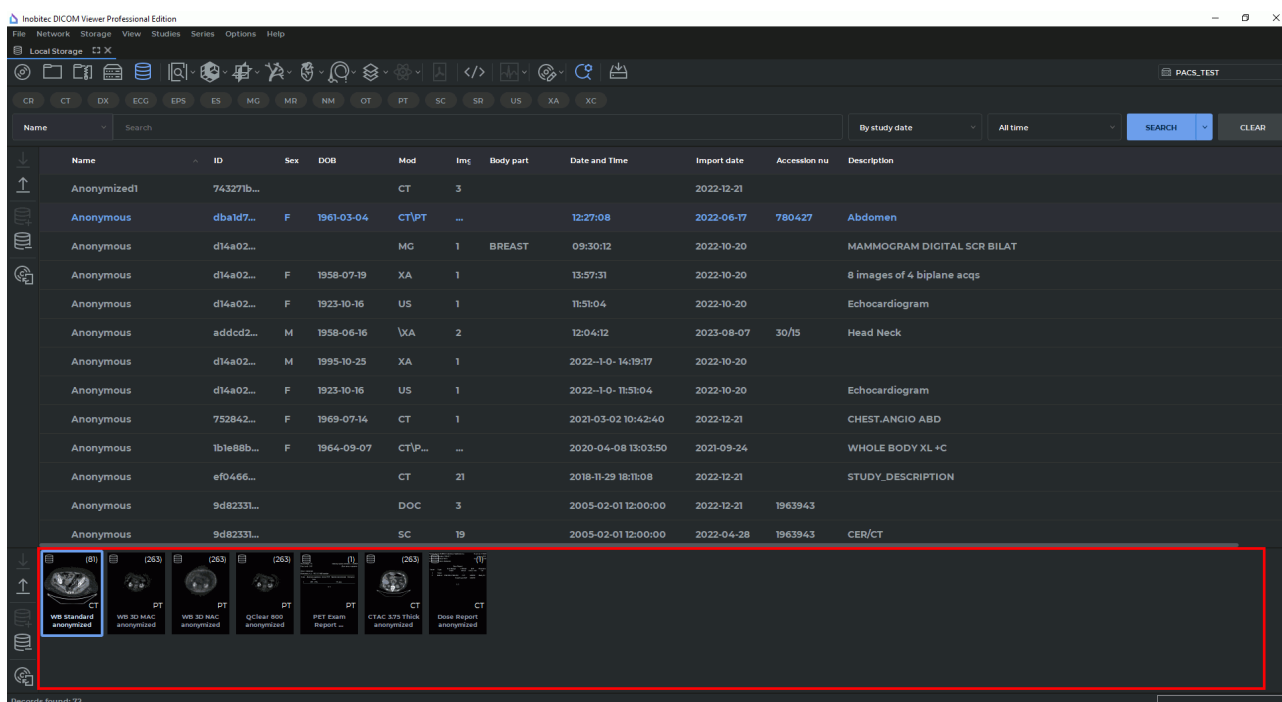

Figure 1.24: Series panel in the DICOM Viewer window

Selecting series is analogous to the studies selecting (see Section 1.9). But if you want to select multiple series by moving the mouse, start moving when cursor is not on the series thumbnail.

## 1.11 Studies and Series Download/Upload Panels

The panels are shown in Fig. 1.25 (**Studies Download/Upload Panel** highlighted in green, **Series Download/Upload Panel** highlighted in red). These panels are identical except that the former is designed to work with studies, and the latter is for series.

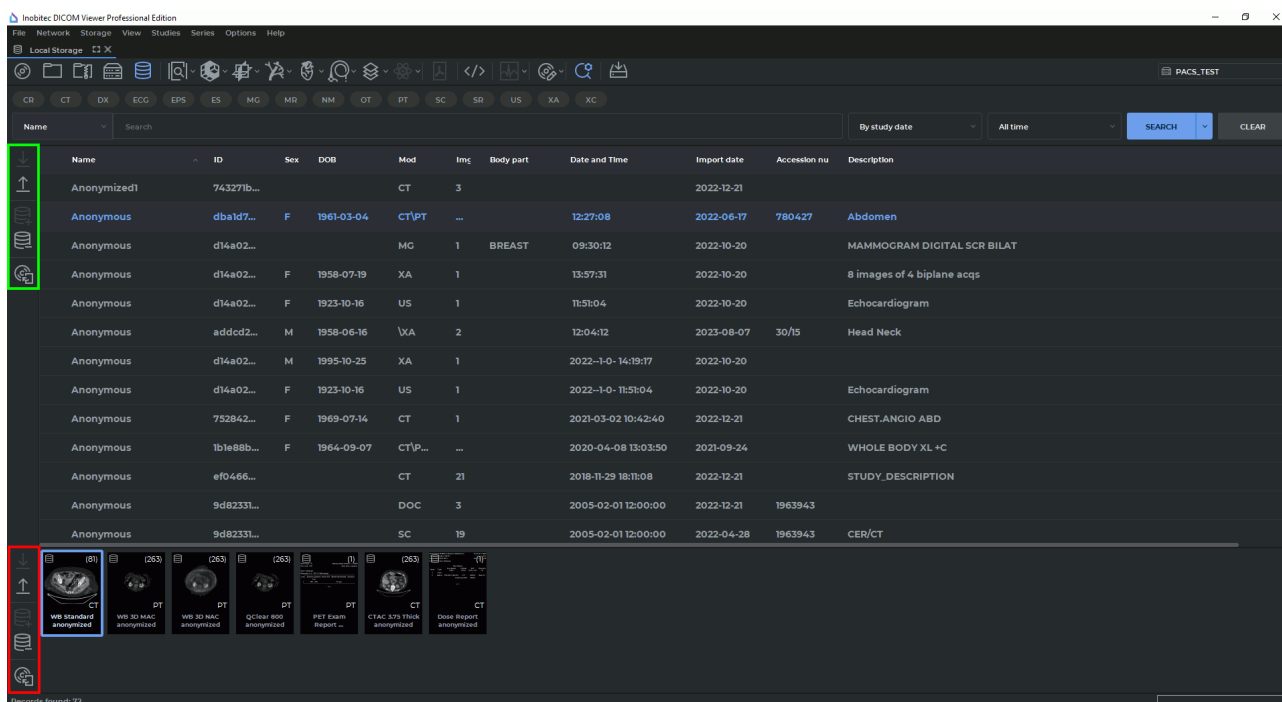

Figure 1.25: Studies and Series download/upload panels in the DICOM Viewer window

Series import/export panel buttons:

	The <b>Download selected series to Local Storage</b> button downloads the selected series to the local storage.
	The <b>Upload selected series to remote server</b> button uploads the selected series to the remote PACS server.
	The <b>Add selected series to Local Storage</b> button adds the selected series to the local storage.
	The <b>Remove the selected series from the Local Storage</b> button deletes the selected series from the local storage.
	The <b>Add selected series to DICOM CD/DVD image</b> button adds the selected series to the CD/DVD Creator. For details on how to work with the creator, see Chapter 15.

If the action corresponding to a button cannot be performed, the button looks pale and cannot be pressed (inactive).

Managing the **Studies Download/Upload Panel** is completely analogous to the **Series Download/Upload Panel**.

These actions are available as well from the context menu and the **Studies** menu item for studies and from the **Series** menu item for series. To open it from the context menu, click the right mouse button on the study.

## 1.12 Information Panel

The panel is displayed in Fig. 1.26 (highlighted in red) and Fig. 1.27. Its left part displays the status of the last operation performed. The right part displays the progress bar for the current action and the data download/upload indicator while working with the PACS server or another DICOM Viewer. Fig. 1.27 illustrates data download from the server.

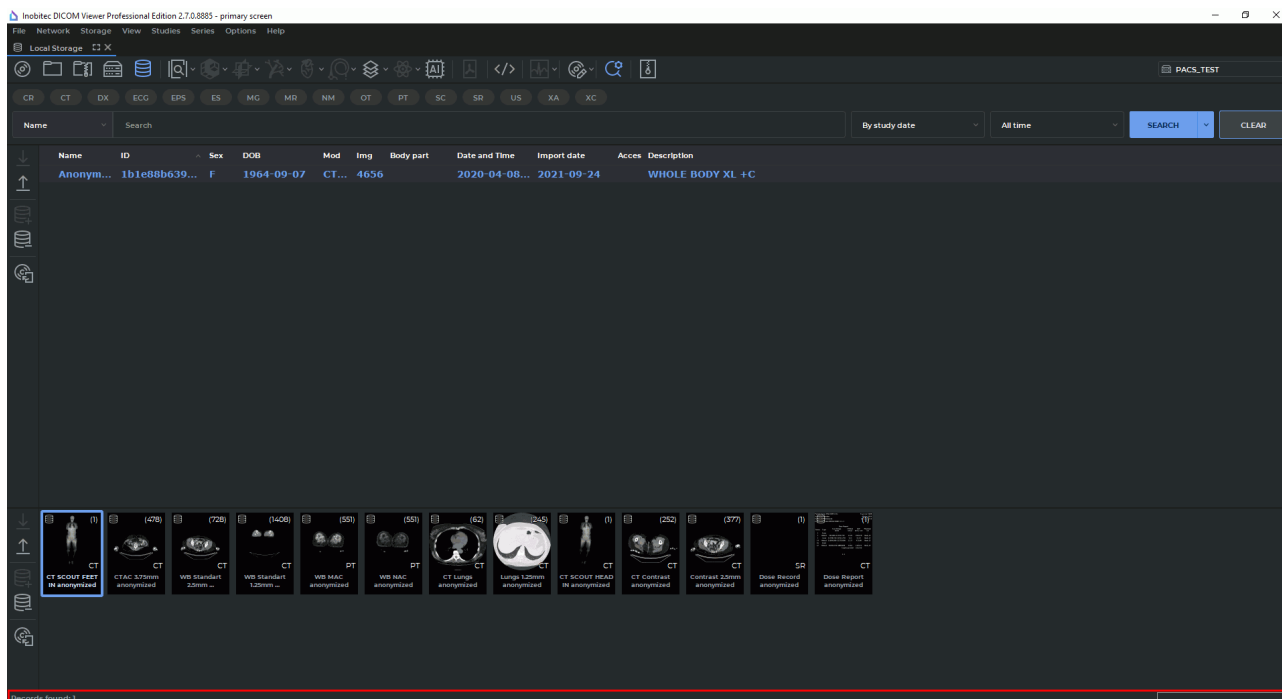



Figure 1.26: Information panel in the DICOM Viewer window



Figure 1.27: Information panel. Download data from the server

When data are downloaded, an animated  icon is displayed. When data are uploaded, an animated  icon is displayed. When no data are being downloaded or uploaded, no icons or progress bar are displayed.

## 1.13 Uncompress series

The following functionality allows to uncompress data and save it. This makes it possible to solve the problems with viewing and uploading compressed data on some remote servers. Uncompressing is possible only for studies in the Local Storage.

To uncompress data:



1. Open a study containing compressed data;
2. Select the series that you want to uncompress. For details on how to work with series, see Section 1.10.
3. Select the **Series** menu and **Create uncompressed copy of series** item. The selected series will be uncompressed, saved to the Local Storage and marked **uncompressed**.

## 1.14 Tool Control Buttons

Starting with the version 2.0, you can use the left, the right and the middle mouse button, which allows you to activate up to three tools at the same time. To activate a tool, click on the tool button with the mouse button. There are two ways to deactivate a tool:

1. Activate another tool with the same button or
2. Click on the tool button with the same mouse button.

On the tool button, you will see a symbol representing the mouse with the respective button selected (see Fig. 1.28).



*Figure 1.28: The tools activated with the left, the middle and the right mouse button respectively (from left to right)*

If a tool is activated from the main menu, from the context menu or with a hot key, it is automatically assigned to the left mouse button.

If a limited number of clicks is needed to create a graphic object (e.g. two clicks for a ruler, three clicks for corner measurements), then the creation process will be completed after these clicks. If you need an unlimited number of points to create a graphic object (e.g. a polygon or an MPR curve), you have to double-click the button with which the tool was activated to complete the creation process. The objects may be activated by mouse-over. When activated, they may be moved or edited.

The objects created with a certain tool can be edited:

- with the button to which this tool is assigned;
- with the left mouse button, no matter whether the tool is activated or not.

If you mouse over the object and click the right button, the right-click menu will pop up. The measurements and markers are activated if you mouse over them. It allows you to move the marker or edit the measurement.

# Chapter 2

## View Flat Images



256 gray shades are used to show tissue density. As there are more than 256 density values, similar values are represented by the same colour. To be able to distinguish between similar values, you need to decrease the window width. In this case, a smaller range of values will be represented by 256 gray shades. If necessary, set the desired the window level value.



In Image Viewer window, diagnosis can only be established on the basis of CT, MR, MG, and XA series.

### 2.1 Open Series

Select a study from the study panel. There are five ways to open a series:

- click the **Image viewer**  button on the toolbar;
- double-click the left mouse button on the study title on the toolbar;
- double-click the left mouse button on the series icon on the series panel;
- drag the series icon to the study panel holding the left mouse button;
- right-click the mouse to call the context menu for the series icon, and select one of the options in the **Image viewer** item.

The series will open in a new tab.

There are three ways to open a series from the explorer window:

- by dragging and dropping the folder with the series from the explorer window to the study list tab. A new study list tab will be opened. The first series of the study will be opened in the new flat image viewer tab;
- by dragging and dropping the folder with the series from the explorer window to the flat image viewer tab stub. The first series of the study will be opened in a new window of the current tab;

- by right-clicking on the selected folder in the Explorer and selecting the **Open with Inobitec DICOM Viewer <Edition> <Version>** from the context menu (see Section 1.5.4). This function is only available on Windows.



**ECG modality series (see Chapter 11) and series containing protocols (see Chapter 18) are opened in the respective tabs. PDF documents are opened in third-party software installed in the user's OS. Series that do not conform to the DICOM standard or series for which there are no special tabs to view are opened in the DICOM tag viewer tab.**

If necessary, change the sorting order of images. To do it, right-click on the image to open context menu, select the **Image sorting** item, and then select one of the displaying modes:

- **No sorting;**
- **Sort by image number;**
- **Sort by image position and phase.**

The current order is marked with flag. The default sorting order is defined by the **Sort by** parameter (see Section 16.7.1).

The series panel will be displayed on the left. To hide/show it select the main menu **Image** and the **Quick series list** item or move the cursor to the panel border so that it would look like this:  and drag the border holding the left mouse button. The series panel is shown in Fig. 2.1.

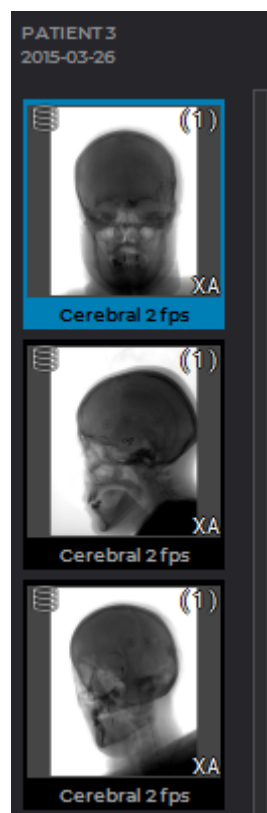



Figure 2.1: Series panel

The DICOM Viewer allows you to open multiple series at a time or the same series multiple times. All series are opened in separate windows of the same tab, and their position will depend on the settings described in Section 2.10.

To open the selected series in the Volume Reconstruction or Multiplanar Reconstruction window, click the **Volume Reconstruction**  or **MPR Reconstruction**  button on the toolbar respectively.

## 2.2 Open Series with Current Settings

The DICOM Viewer allows you to open series of the opened study with the window level and width set for the previously opened series. To do this:

1. Open any series and set the window level and width.
2. Select the study view window by clicking the left mouse button on the window header (marked by the arrow in Fig. 2.2).
3. Open another series of this study. The series will be opened with the parameters of the window level and width specified earlier.
4. Repeat Steps 2 and 3 if necessary. The settings for the first opened series will be used.
5. Change the window level and width for the first opened series if necessary.

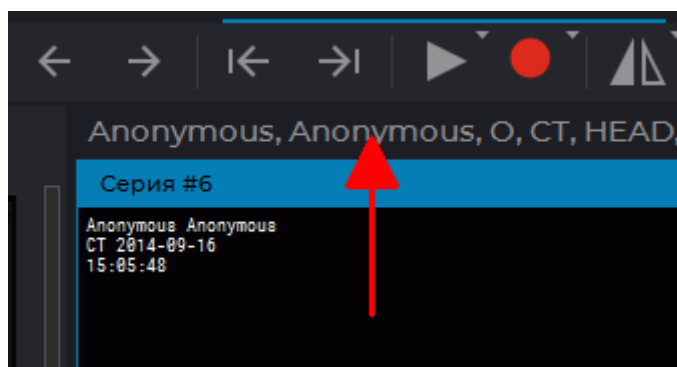

Figure 2.2: The window header is marked by the arrow

## 2.3 Context Menu of the Image Viewer Tab

The **Image Viewer** tab is provided with a context menu (see Fig. 2.3). To bring up the context menu, right-click on the Image Viewer window.

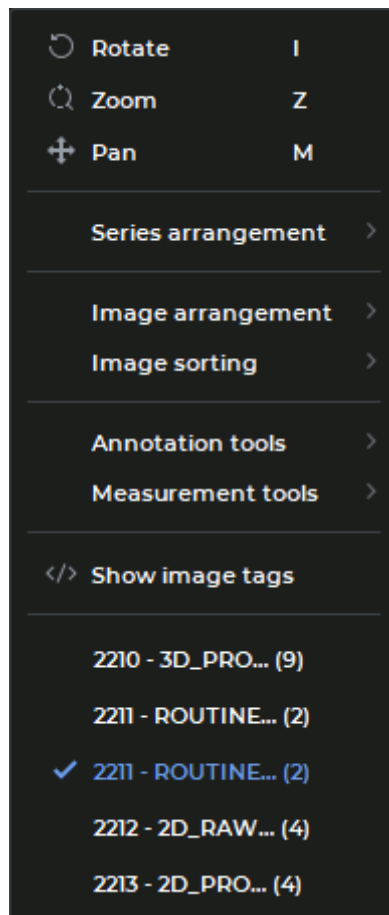

Figure 2.3: The context menu of the Image Viewer tab

The context menu of the **Image Viewer** tab provides for:

- zooming, panning, and rotating tools (see Section 2.16);
- series arrangement settings (see Section 2.10);
- image arrangement settings (see Section 2.11);
- image sorting order settings (see Section 2.1);
- graphic label tools (see Section 2.32);
- measuring tools (see Section 2.19);
- command to open DICOM tag viewing tab for the current series (see Chapter 17);
- list of series from the current study containing images.

To see the list of series on the context menu of the **Image Viewer** tab, enable the **Show series list in context menu** option in the program settings (see Section 16.7.1). The option is enabled by default.

Series are shown on the list in the following format:

<Series number from DICOM tags> - <Series description> (<Number of images>).

For example, *1000 - Anonymized (200)*. The current series is highlighted on the list.

To switch to the series required, left-click on its name on the list.

The list of series is only shown on the context menu if a window with images has been selected. If a study window or an SR series window has been selected, the context menu will be shown without the series list.

## 2.4 Working with Several Monitors and Split Screen

The DICOM Viewer allows you to split the screen into two parts or work with two monitors connected to the same computer. For details on how to set up your monitor, see Section 16.5.

Let us assume that both displays are used, and each one is split (Fig. 2.4). In this case, the DICOM Viewer will be running in four autonomous windows. To close the DICOM Viewer just close any of its windows.

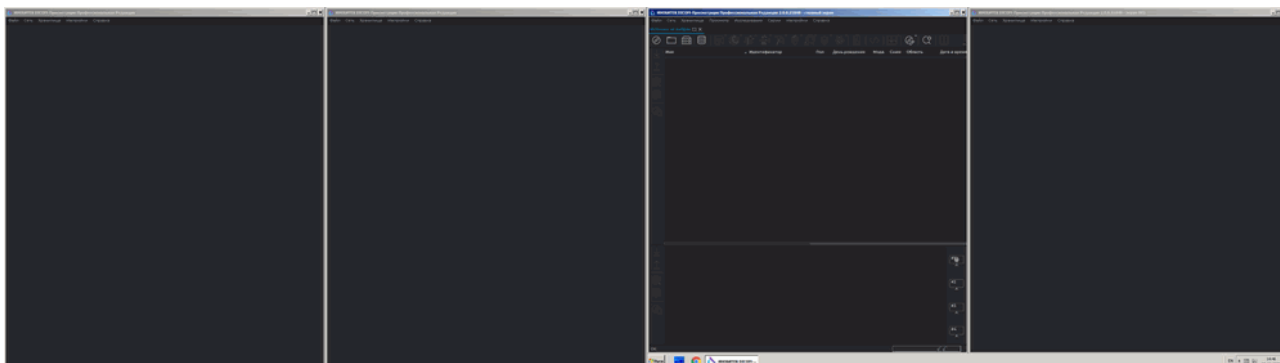

*Figure 2.4: DICOM Viewer with two split screens. The right display is the main one*

In the illustration above, the right monitor is the main one, so the **Study list** tab is open in its left window. To open this tab in any of the three remaining windows, select the **File** menu and the **Study list** item in this window. The series panel on the right side displays the window panel (Fig. 2.5).



Figure 2.5: Window panel

Each window has a display icon corresponding to it.

- the first icon corresponds to the left window of the main display;
- the second icon corresponds to the right window of the main display;
- the third icon corresponds to the left window of the additional display;
- the fourth icon corresponds to the right window of the additional display.

The OS settings determine which display is the main one. The icon corresponding to the current window is displayed against a light background. In Fig. 2.6, the **Study list** tab is open in each window, and you can see the correspondence between the windows and the display icons. The right display is the main one.

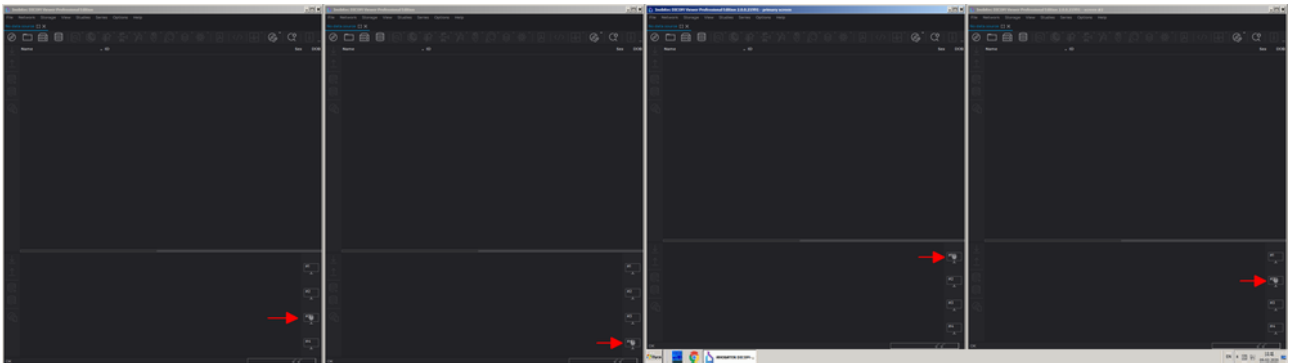



Figure 2.6: Correspondence between open windows and display icons on series panels

To open a series in a certain window:

1. Load studies in any tab.
2. Select a study from the study panel.

3. Hold the left mouse button and drag the series icon from the series panel to the display icon corresponding to the window to open the series in.
4. Release the left mouse button. The series will open in the window corresponding to the display icon.

If the cursor is not located on the display icon, it will look as follows:  . This means that dragging is impossible. As soon as the cursor is over the display icon, it changes to  , and you can drag the icon.

## 2.5 Resampling filter

To change the Resampling filter, open the **Image** main menu, select the **Resampling filter** menu item and in the submenu that opens, select a filter. The active filter is marked with a flag (Fig. 2.7)

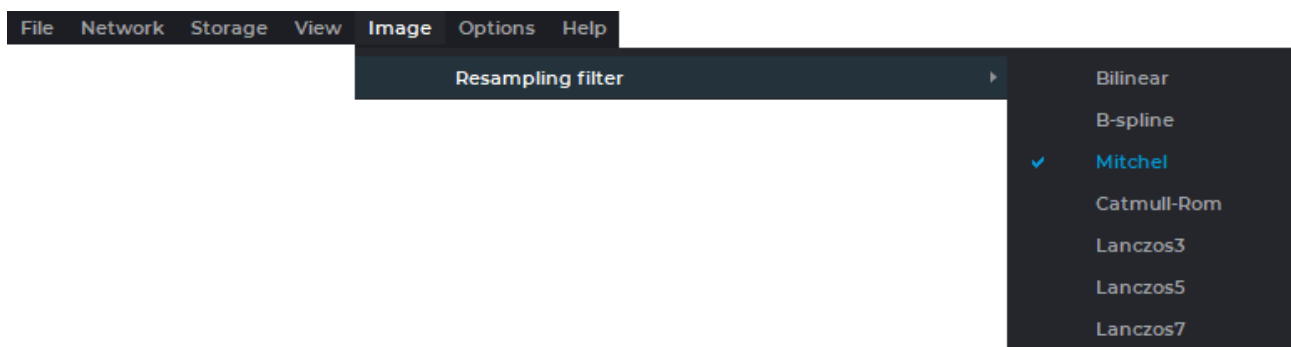

Figure 2.7: The Resampling Filter menu

The following filters are available:

- Bilinear;
- B-spline;
- Mitchel;
- Catmull-Rom;
- Lanczos3;
- Lanczos5;
- Lanczos7.

By default the Mitchel filter is active.



**When filters are used (except for the Bilinear filter), distortions may occur. If you see any dubious artifacts, select the Bilinear filter.**



## 2.6 Image Filters

---

Functionality is available in the **Pro** edition

---



**This function cannot be used for establishing a diagnosis**

A filter is an algorithm for transforming series images with various effects in the image viewer window. The DICOM Viewer provides filters for blurring images, changing sharpness and reducing visual noise.

Filters for image processing are available in the **Image Viewer**, **MPR reconstruction**, **Vessel analysis** and **Coronary artery analysis** tabs.

### 2.6.1 Preset Filters

---

Functionality is available in the **Pro** edition

---



**This function cannot be used for establishing a diagnosis**

To choose and apply a preset filter in the **Image Viewer** tab, on the main menu, select **Image->Filters** and from the filter list, select the desired filter.

You can choose preset filters with the following parameters:

- **Blur 1** (Sigma=1);
- **Blur 2** (Sigma=1.5);
- **Blur 3** (Sigma=2);
- **Sharpen 1** (Sigma=1; Sharpness weight=0.5);
- **Sharpen 2** (Sigma=1; Sharpness weight=0.7);
- **Sharpen 3** (Sigma=1; Sharpness weight=0.9);
- **Median 1** (Radius=1);
- **Median 2** (Radius=2);
- **Median 3** (Radius=3).

In the **Image Viewer** tab, the filter is applied to the selected window. If you select a series window, the filter is applied to the whole series. If you choose a study window, it is applied to all the series of the study.

Only one filter may be applied to a selected series window. The current filter is highlighted with blue on the list of filters, and marked with a flag. The name of the filter is shown in the left-hand bottom corner of the window for which the filter is used.

If you apply a filter to an image, you will see an asterisk «\*» symbol in the ROI measurement results and intensity value line. It informs the user that the measurement results are affected by the filter applied.



**An image to which a filter has been applied is not original, and the measurement results may be inaccurate.**

Preset filters are switched cyclically (see Section 2.6.3).

After the window is closed, the preset filter is reset and is not applied when the window is opened again.

## 2.6.2 User Filters

---

Functionality is available in the **Pro** edition

---



**This function cannot be used for establishing a diagnosis**

The DICOM Viewer provides an opportunity to apply customized user filters. There are three user filters on the main menu of the program:

- **Blur;**
- **Sharpen;**
- **Median.**

To set the parameters and apply a user filter, check one of the user filters on the list of filters of the main menu.

In the dialog box that pops up, set the following parameters:

- for the **Blur** filter:
  - **Sigma** parameter. The range of values is from 0.01 to 5.0. The pitch is 0.01. The default value is 0.01;
- for the **Sharpen** filter:
  - **Sigma** parameter. The range of values is from 0.01 to 5.0. The pitch is 0.01. The default value is 0.01;
  - **Sharpness weight** parameter. The range of values is from 0.01 to 0.99. The pitch is 0.01. The default value is 0.01;
- for the **Median** filter:
  - **Radius** parameter. The range of values is from 1 to 5. The pitch is 1. The default value is 1.

Fig. 2.8 shows the dialog box for customizing the **Sharpen** user filter.

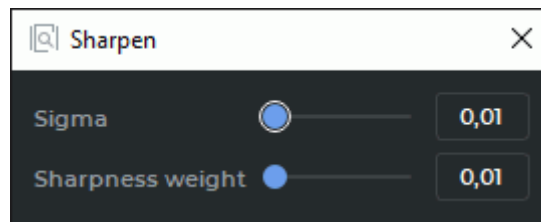

Figure 2.8: Dialog box for customizing the **Sharpen** user filter

There are several ways to set the values of parameters in the dialog box for user filters:

- move the slider or scroll the mouse wheel while the cursor is on the track bar;
- enter the parameter value in the field on the right-hand side of the slider.

When parameters are changed in the dialog box for user filters, the changes are simultaneously reflected in the viewer window. When the dialog box is closed, the current user filter is not reset.

The values of the parameters are saved and applied next time you select the user filter.

### 2.6.3 Actions with Filters

---

Functionality is available in the **Pro** edition

---



**This function cannot be used for establishing a diagnosis**

There are several ways to activate a filter:

- select a filter in the filter list of the main menu by marking it with the flag;
- press the hotkey for the filter. Hotkeys for filters are not provided by default. For details, see Section 16.8;
- switch the current filter with the help of hotkeys or commands on the list of filters.

To go to the next or previous filter, proceed as follows:

- on the list of filters on the main menu, select **Next filter** to switch to the next filter or **Previous filter** to switch to the previous filter;
- press the **Ctrl+I** key combination to switch to the next filter or **Ctrl+Shift+I** to switch to the previous filter.

Preset filters are switched cyclically. After the last preset filter on the list you go to the first one. You do not switch to user filters.

There are several ways to reset the current filter:

- select the current filter in the filter list of the main menu. The flag next to the filter will be removed;
- select the **Reset filter** command on the list of filters on the main menu;
- press the **Shift+I** key combination on the keyboard.

You can assign a hotkey to each filter (see Section 16.8).

## 2.7 View Images in a Series

When a series is opened, its first image is displayed in the series window.

The window for viewing series is shown in Fig. 2.9.

The data in the header of the series viewer windows of the **Image viewer** or **CLUTs** tab are displayed as follows:

*Series #<Sequence number of the series in the study> (<DICOM data series number>).*

E.g.: **Series #3 (201)**.

The value in the parenthesis is provided by the *SeriesNumber(0020,0011)* tag. If there is no value provided for the *SeriesNumber(0020,0011)* tag, only the series sequence number will be shown in the header of the series viewer window.



**DICOM data series number are not shown for temporal series obtained as a result of combining several series in a multiphase or merged series.**

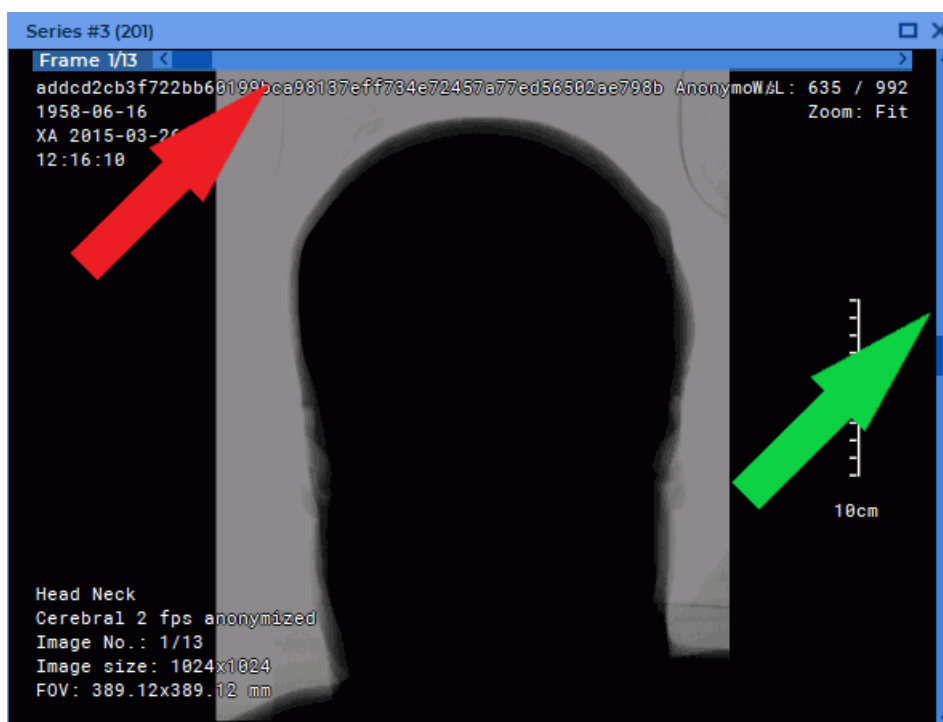



Figure 2.9: Series window



On the right-hand side of the window, you can see a scroll bar for scrolling images of the series (marked by the green arrow). If the series contains several phases or is a multiframe

series, at the top of the window you will see an additional scroll bar (marked by the red arrow) for switching between phases or frames. In the window, you will find the information on the current image (see Section 2.29).

There are five ways to switch to other images:

- Roll the mouse wheel up to switch to the previous image or down to go to the next one. One click of the wheel changes the position by one image.
- Use the scrollbar on the right side of the series window to move to the target image. To change the position by one image, click the left mouse button on the arrow or the bar above or below the scroll.
- Click the left mouse button holding the **Shift** key. If the current image is the last in the series, a click will switch you to the first image. Similarly, click the left mouse button holding the **Ctrl** key to move to the previous image.
- Use the  **Scrolling** tool. Activate the tool on the toolbar by clicking the left/right/middle mouse button. To continue work with this tool, use the button with which the tool was activated. To learn more about tool control, see Section 1.14.

If it is impossible to switch between images, the tool may be used for scrolling frames.

- Use the arrow buttons on the toolbar:  ,  .

## 2.8 Switch between Series

There are two ways to switch between series in the series window:

- Use the arrow buttons on the toolbar:  ,  ;
- Use the context menu: right-click on the image and select a series from the list for the current study (see Section 2.3).

## 2.9 View Several Studies at a Time

To open several studies simultaneously:

1. From the program window:
  - (a) Open a study by opening any of its series.
  - (b) Switch to the tab containing the study list.
  - (c) Select another study and drag one of its series to the tab with the opened study (highlighted in red in Fig. 2.10).
2. From the explorer folder:
  - (a) Open a study by opening any of its series.

- (b) Select the folder with the another study and drag one of its series to the tab with the opened study (highlighted in red in Fig. 2.10). The first series of another study opens in a new window of the current tab.

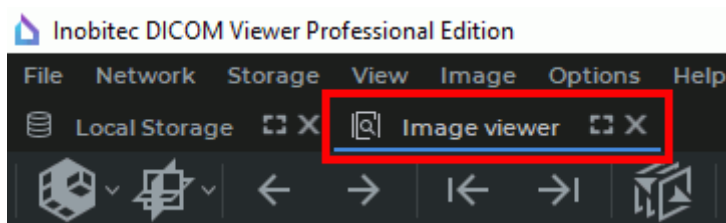

Figure 2.10: Study view tab

The series are opened in the same tab but in different study view windows.

There are several ways to maximize any of the series windows to full screen and restore its size:

- click on the  **Expand** button in the right-hand upper corner of the series window;
- double-click with the left mouse button on the title of the series window;
- double-click with the left mouse button on the series window;
- if the measurement or graphical annotation tool is activated with the left button, double click the left mouse button inside the window.

The series panel is displayed on the left, and the series are grouped by study (Fig. 2.11).

The arrows point to series panel stubs. The series panel at the top of the picture is expanded, and the bottom series panel is folded. To unfold it, just click the left mouse button on the header (marked by the arrow below). Only one series panel may be unfolded at a time, the rest will be folded.

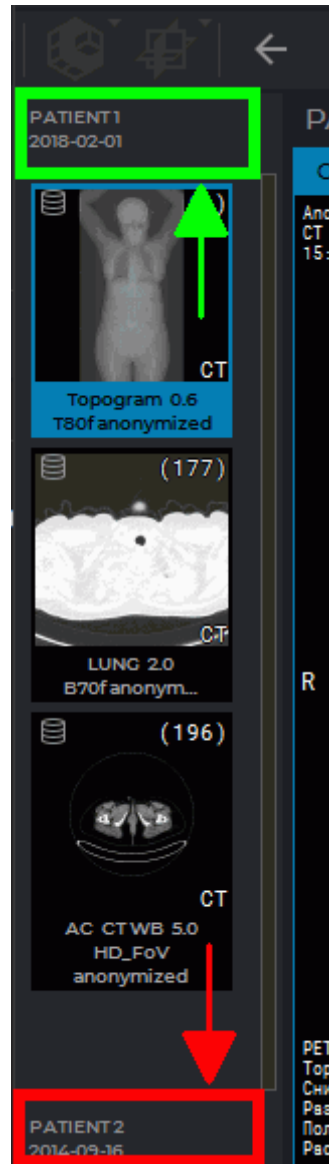

Figure 2.11: Series panel for several studies. Study titles are marked by arrows. The top study is unfolded, and the bottom study is folded

## 2.10 View Multiple Series

There are several modes for positioning series windows in the study window.

You can choose the mode for arranging series in the study window in the **Series arrangement** button menu. There are three ways to open this menu:

1. Click the arrow on the right-hand side of the **Series arrangement** button on the toolbar and select the arrangement mode from the drop-down menu (Fig. 2.12).

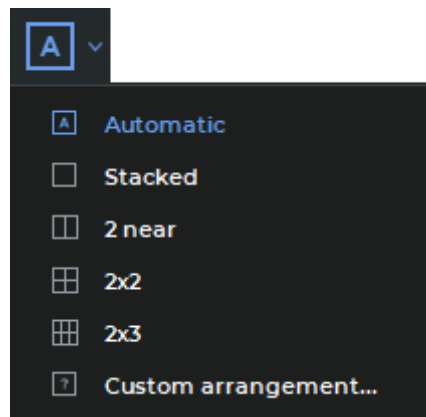

Figure 2.12: Series arrangement menu

2. Move the cursor to the window with the open series, right-click and select **Series arrangement** command from the shortcut menu.
3. Select **Series arrangement** from the **Image** section of the main menu.

You can choose from the following series arrangement modes:

- **Automatic** — the default series arrangement mode (see Section 2.10.1);
- **Stacked** — only one series window may be opened in the study window (see Section 2.10.2);
- **2 near** — the study window is divided into two parts (see Section 2.10.3);
- **2x2** — the study window is divided into four parts (see Section 2.10.3);
- **2x3** — the study window is divided into six parts (see Section 2.10.3);
- **Custom arrangement...** — the user customizes the arrangement of series windows (see Section 2.10.4)

The current series arrangement mode is highlighted in blue on the toolbar and on the menu.

There are several ways to maximize any of the series windows to full screen and restore its size:

- click on the **Expand** button in the right-hand upper corner of the series window;
- double-click with the left mouse button on the title of the series window;
- double-click with the left mouse button on the series window;
- if the measurement or graphical annotation tool is activated with the left button, double click the left mouse button inside the window.



### 2.10.1 Auto Mode

This mode is active by default. If two or more series are open, they will be located in the window and scaled automatically, occupying the entire window. Five series are displayed in Fig. 2.13.

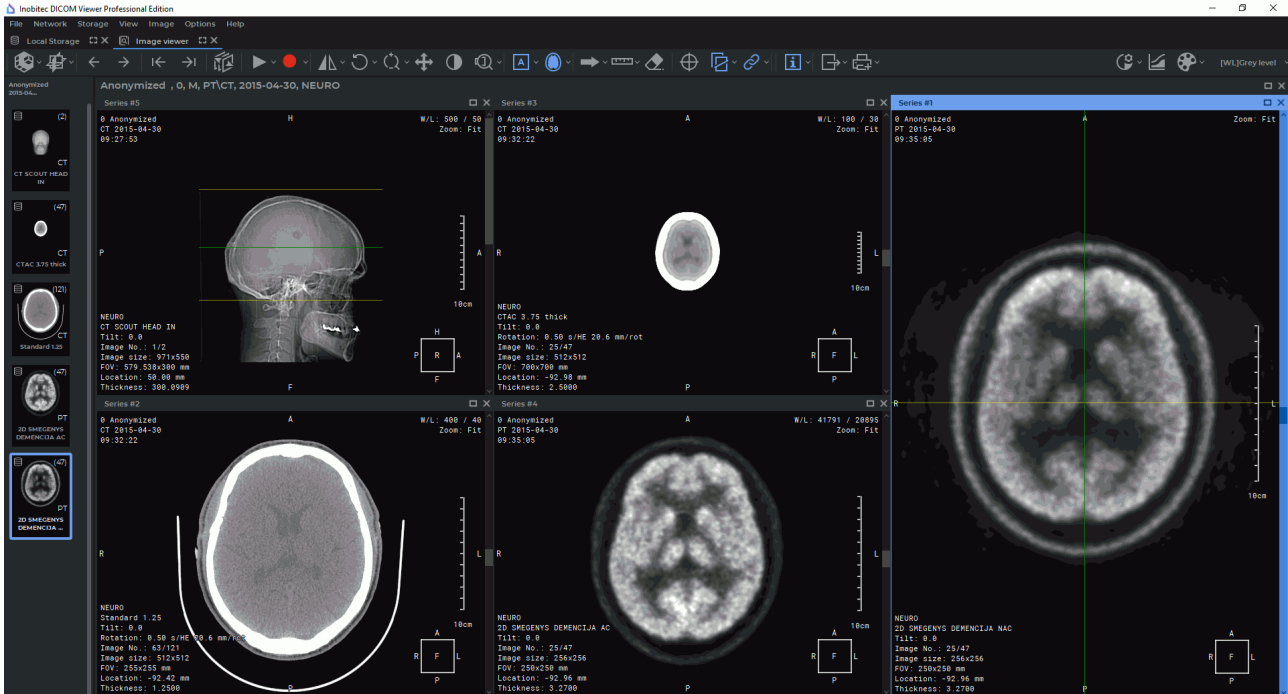

Figure 2.13: Automatic display of series

There are three ways to activate this mode:

- select the  **Automatic** item in the **Series arrangement** button menu on the toolbar;
- locate the cursor to the window with the open series, right-click and select command **Series arrangement->Automatic** on the context menu;
- on the main menu, select **Image->Series arrangement->Automatic**.

### 2.10.2 Stacked Mode



This mode allows you to open only one series in the study window. If you try to open another series, the current series will be closed.

Activate this mode in several ways:

- select the  **Stacked** item in the **Series arrangement** button menu on the toolbar;
- locate the cursor to the window with the open series, right-click and select command **Series arrangement->Stacked** on the context menu; on the main menu, select **Image->Series arrangement->Stacked**.

### 2.10.3 Grid Mode

In this mode the study window is split into parts, and a series window can be opened in each of them.

To set up a 1x2, 2x2 or 2x3 grid, select the  **2 near**,  **2x2** or  **2x3** item in the **Series arrangement** button menu.

These grid configuration types are available from the image context menu. Locate the cursor to the window with the open series, right-click and select command **Series arrangement**.

Selection of 1x2, 2x2 or 2x3 grid is available on the main menu **Image->Series arrangement**.

If the selected grid configuration has fewer cells than there are open series in the study, a warning dialog box pops up (Fig. 2.14), in which the program asks for a permission to close the open series.

Click **OK** to close the series, or **CANCEL** to cancel.

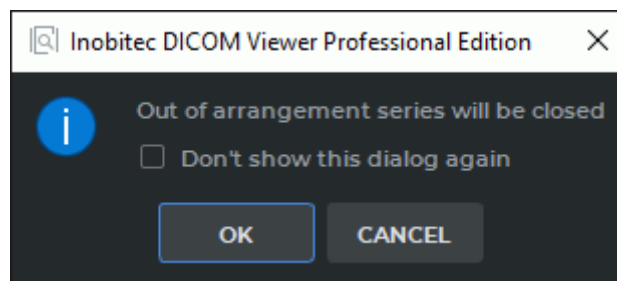

Figure 2.14: Warning dialog box

There are two ways to disable the warning dialog box:

- Check the **Don't show this dialog again** box in the dialog (Fig. 2.14) and click the **OK** button.
- On the main menu, select **Options->Settings...->Modules->Image Viewer**, then choose the **Image arrangement** tab and uncheck the **Confirm series closure on the arrangement changing** box. For more information on the module settings see Section 16.7.1.

Click **OK** to apply the settings or **Cancel** to cancel.

### 2.10.4 Custom Mode

A grid may have from 1 to 100 cells. The maximum number of rows and columns is 10. This mode can be set by default (see Section 16.7.1).

Fig. 2.15 illustrates a 2\*4 grid with three cells filled.

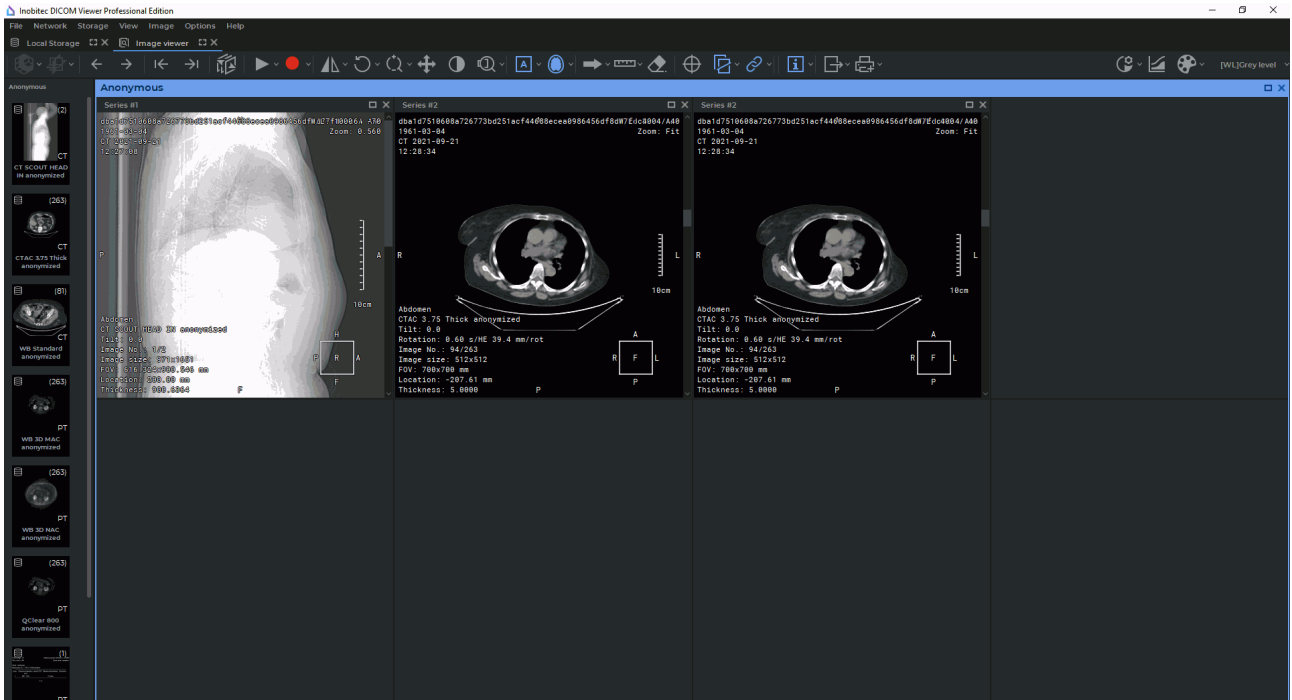

Figure 2.15: Displaying series in a 2\*4 grid

To define your own grid configuration perform the following:

- select the **?** **Custom arrangement...** item in the **Series arrangement** button menu;
- locate the cursor to the window with the open series, right-click and select command **Series arrangement->Custom arrangement...** on the context menu;
- on the main menu, select **Image->Series arrangement->Custom arrangement...**

This mode can be set by default (see Section 16.7.1).

In the **Row/Column setting** dialog box (Fig. 2.16) enter the number of rows and columns of the grid.

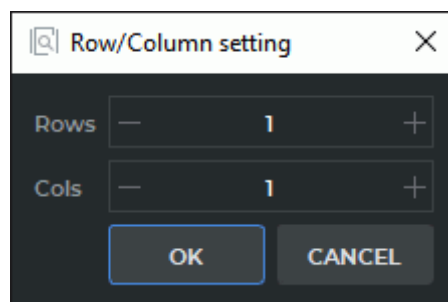



Figure 2.16: Row/Column setting dialog box

For customized grids, the DICOM Viewer allows for auto-fill of the cells with the current study series. The auto-fill function is disabled by default. To enable it, on the main menu,

select **Options->Settings...->Modules->Image Viewer**, then choose the **Image arrangement** tab and check the **Automatic fill with series** box. When a series is opened in a new tab, the other series are opened in the cells available. The cells are sorted by serial number.

When positioning series on the grid, the DICOM Viewer allows you to move the boundary between cells. To do this, move the cursor to the panel border so that it would look like  or  and drag the border holding the left mouse button. Setting the priority of horizontal or vertical separator is described in Section 16.7.1.

## 2.11 View Multiple Images in the Same Series Simultaneously

To select the mode for viewing images of the same study, right-click on the image to open context menu, select the **Image arrangement...** item, and then select one of the displaying modes. In general, they are similar to the modes for displaying series.

Image displaying modes:

- Stacked. Set by default. A single image is displayed in the window.
- 2 below. Two images are displayed in the window, one above the other. The image order is downward. The entire screen is scrolled at once (i.e. if Images 1 and 2 of the same series are initially displayed, Images 3 and 4 will be displayed next), or one Image is scrolled at once. Selection of the desired mode is described in Section 16.7.1). To apply a new configuration, you should reopen the Flat Image View Tab.
- 2 near. This mode is similar to the previous one, but the images are positioned horizontally, and the order is from left to right.
- 2x2. Two columns and two rows of images are displayed in the window. The order is downward from left to right.
- 2x3, 3x2, 3x3, 4x4. Similar to the previous item.
- Custom arrangement. The number of columns and rows is set manually (from 1 to 10). This configuration can be set by default (see Section 16.7.1).

Fig. 2.17 illustrates a 3x2 grid.

## 2.11. VIEW MULTIPLE IMAGES IN THE SAME SERIES SIMULTANEOUSLY

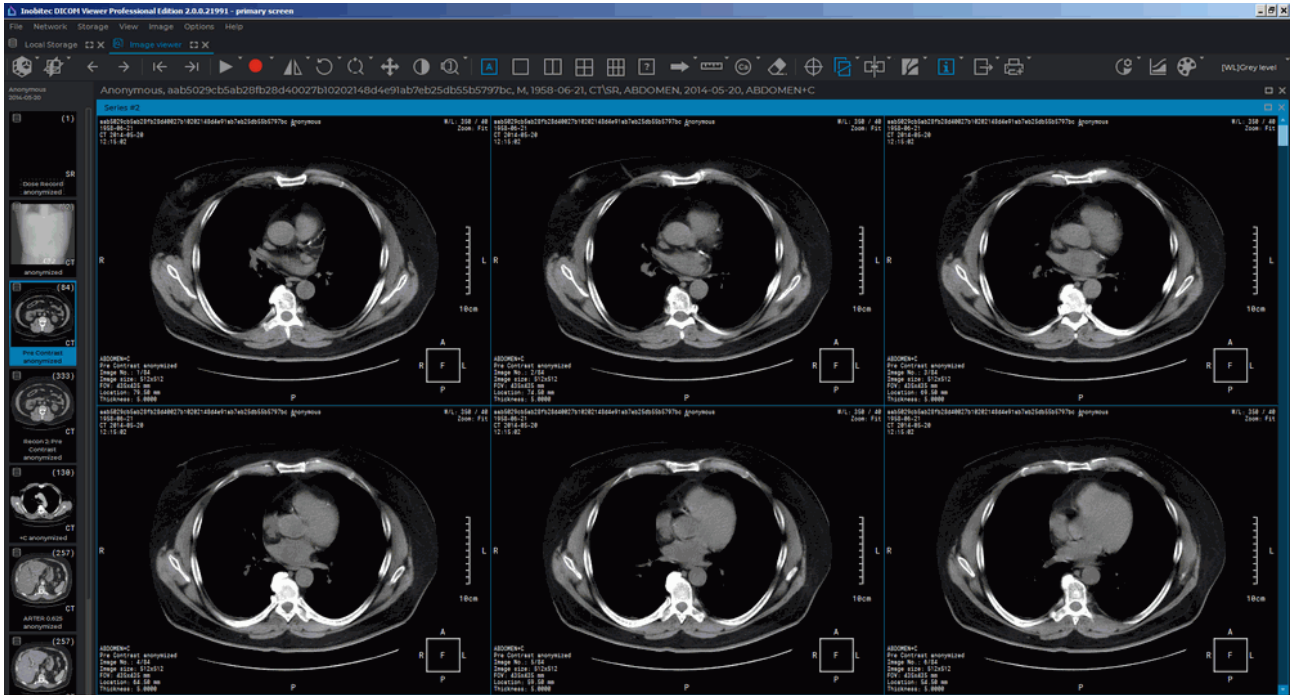

Figure 2.17: Images in a series displayed in a 3x2 grid

Multiple series may be displayed on the screen simultaneously, and each series window may contain multiple images. In Fig. 2.18, three series windows are open, the first one displays a single image, the second contains a 2x2 grid, and the third shows a 4x4 grid.

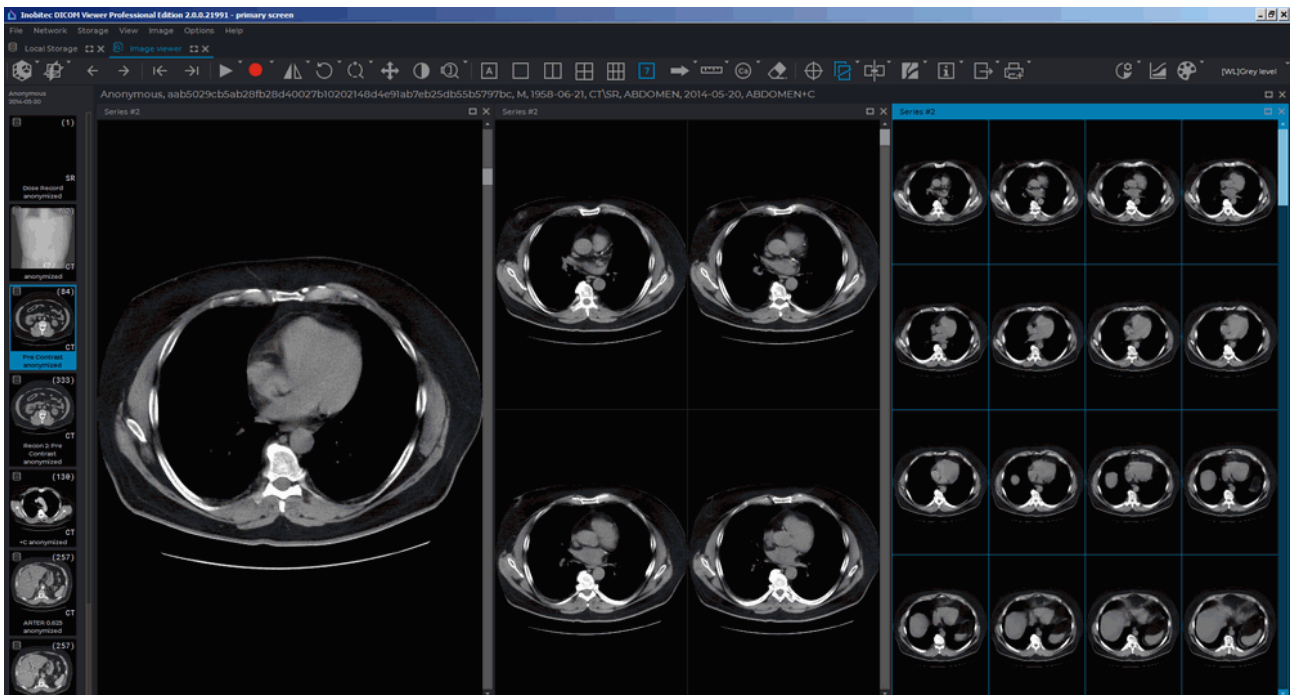

Figure 2.18: Displaying multiple series and multiple images in a series

To set default viewing images modes for series of different modalities, add settings for these modalities (see Section 16.7.1). Use only English letters to specify modality. The modality designation should coincide with the designation on the icon of the series (Fig. 2.19).

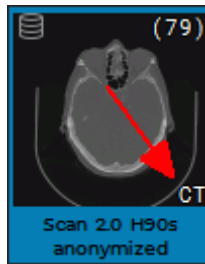

Figure 2.19: Series modality designation is marked by the red arrow

## 2.12 Viewing Several Series as a Single Multiphase Series

Several series of a single study may be merged into a single multiphase series. Such a series may be used for assessment of contrast distribution in tissues at regular time intervals, e.g. for viewing it in the digital subtraction angiography (DSA) or perfusion parameters estimation mode.

The following series may be merged:

- saved in the local storage. If the PACS server has been chosen as the DICOM data source, save the series in the local storage;
- having the same modality;
- having the same *FrameOfReferenceUID* (0020, 0052) tag value.

To merge several series of the same study in a multiphase series, proceed as follows:

1. Select the study on the study panel to see the list of series.
2. Select several series on the list in one of the following ways:
  - select the first and the last series you need while holding the **Shift** button;
  - mouse over the series you need while holding the left mouse button;
  - select several series placed in different parts of the list while holding the **Ctrl** button.
3. Hover over the selected series, click the right mouse button and select the **Image viewer (open as a single series)** option on the menu. Choose one of the three viewing options:
  - **Show at window 1** opens images in a new tab;
  - **Show as detached window** opens images in a separate window;
  - **Show fullscreen** opens images in the full screen mode. To exit the full screen mode, press **Esc** or **F11** on the keyboard.

If the selected study series cannot be merged, a dialog box notifying of an error will pop up. To learn about the cause of the error, click the **SHOW DETAILS...** button.

The merged multiphase series will be opened in the flat image viewer window. A merged series may be opened from the **Image viewer** tab in the **Volume reconstruction** and **MPR reconstruction** tabs.

The new merged series will be added to the list of series of the current study. The description of the merged series comprises a list of all the series included in it, separated by a space followed by a *Merged* prefix. The series may be opened in the **Volume reconstruction** and **MPR reconstruction** tabs. To delete a merged series from the list of series, click the **Remove the selected series from the Local Storage**  button on the series panel.



The following options are unavailable for a merged series:

- saving in a local storage;
- loading to the PACS server;
- adding to a CD/DVD image;
- viewing tags.

When the list of studies is updated, the merged series is deleted automatically.

## 2.13 Viewing Orthogonal Projections of Images

The DICOM Viewer provides the user an opportunity to change view for the series shown in the **Image Viewer** tab.

The button for viewing orthogonal projections may appear as  ,  or  , depending on the variant selected.

There are several ways to choose the view for the series in the selected window:

- click the orthogonal projection button or the arrow on the right-hand side of the button. Select one of the options on the drop-down list (Fig. 2.20);
- press the **Shift+A** combination on the keyboard to switch to the axial projection, **Shift+C** to switch to the coronal projection, or **Shift+S** to switch to the sagittal projection. These hotkeys are assigned by default. You can assign new hotkey combinations in the **Tools** section of the **Hotkeys** settings (see Section 16.8).

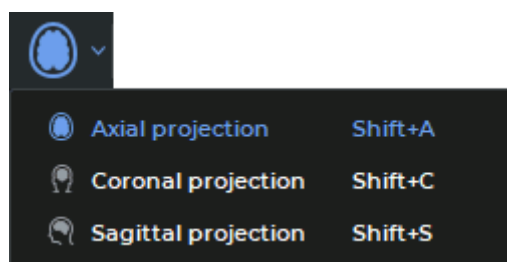

Figure 2.20: Orthogonal projection drop-down list

The active projection for the selected window is highlighted in blue on the toolbar and on the drop-down menu.

The default projection for the series is the same as the one used in which it was received from the medical equipment. The respective option is activated on the Orthogonal projection drop-down list. Other options are available for series that can be images sorted by position and phase.

If only a part of the series has been loaded and the user chooses an orthogonal projection different from the one used in which it was received from the medical equipment, the projection will be built on the basis of the data that have already been loaded. If the number of images in the initial series is changed, a new orthogonal projection will be built the next time. If the number of images in the initial series stays the same, the orthogonal projection that was built earlier will be displayed.

If you choose an orthogonal projection in the same viewer window for a second time, the projection will be opened on the slice that was the last to be viewed.

All the operations available for the projection that was used in which it was received from the medical equipment, e.g. measurements, viewing several series, synchronization etc., may be performed with any orthogonal projection.

Images of series may be sorted and tags may be displayed only for the projections that were used in which it was received from the medical equipment. To change the image sorting type for all the series open in the viewer window, open the context menu by right-clicking on the window header, choose the **Image sorting** section and one of the sorting options.

When you return to the orthogonal projection that corresponds to what we got from the medical equipment, the image sorting does not change.

The Orthogonal projection drop-down list is not available for series:

- which cannot be sorted by **Sort by image position and phase**;
- having less than 2 pictures for at least one phase;
- consisting of images based on the RGB color model.

The series that were opened from the Image Viewer tab in the **Volume Reconstruction, MPR reconstruction** tabs are only displayed in the projection used in which it was received from the medical equipment.

The **Calcium scoring** tool works independently with each orthogonal projection of the series.

When the window width and level parameters are customized, the thumbnail of the active series in the chosen orthogonal projection is shown in the **W/L settings** dialog box.

The current series in the chosen orthogonal projection is shown in the histogram and the **CLUTs** tab.

## 2.14 Play images



The DICOM Viewer allows you to automatically play back images of a series at a certain speed. To set up playback, click on the right part of the **Play**  and choose parameters.

1. If the series contains several phases or is multiframe, then the DICOM Viewer allows you to switch between the playback of images, phases and frames. To switch ,



select the **Play images**, the **Play phases** or the **Play frames** item from the «**Play**» button context menu. The selected item is marked with a flag. Only the items suitable for this series are available on the context menu.

2. Select the speed (5, 10, 20 or 25 frames per second). If you want to set a different playback speed, select the **User defined...** item and in the dialog that opens, set the value from 1 to 100. The selected speed will be marked with a flag.
3. If you want to play images cyclically, select the **Loop** item. The item will be marked with a flag. To disable the cyclic playback, select this command again. The flag will be removed.

To play the images click on the  button on the toolbar. The button looks like .

To end playback, click on the  **Pause** button.

## 2.15 Video recording

Functionality is available in the **Pro** edition

The DICOM Viewer allows you to record video for the selected image viewing window. If you use the View Multiple Series mode (see Section 2.10), then video will be recorded only from the selected window. If you are viewing multiple images in a series at the same time (see Section 2.11), then video will be recorded only for the left bottom image area (highlighted in red in fig. 2.21). The following objects will be recorded:

- tissues;
- measurements;
- annotations;
- scout lines;
- tags;
- orientation cube;
- ruler;
- synchronization crosshair.

The following objects will not be recorded:

- cursor;
- dialog windows.

Video recording will be stopped if:

- focus is moved to another window within this tab;

- window size is changed.

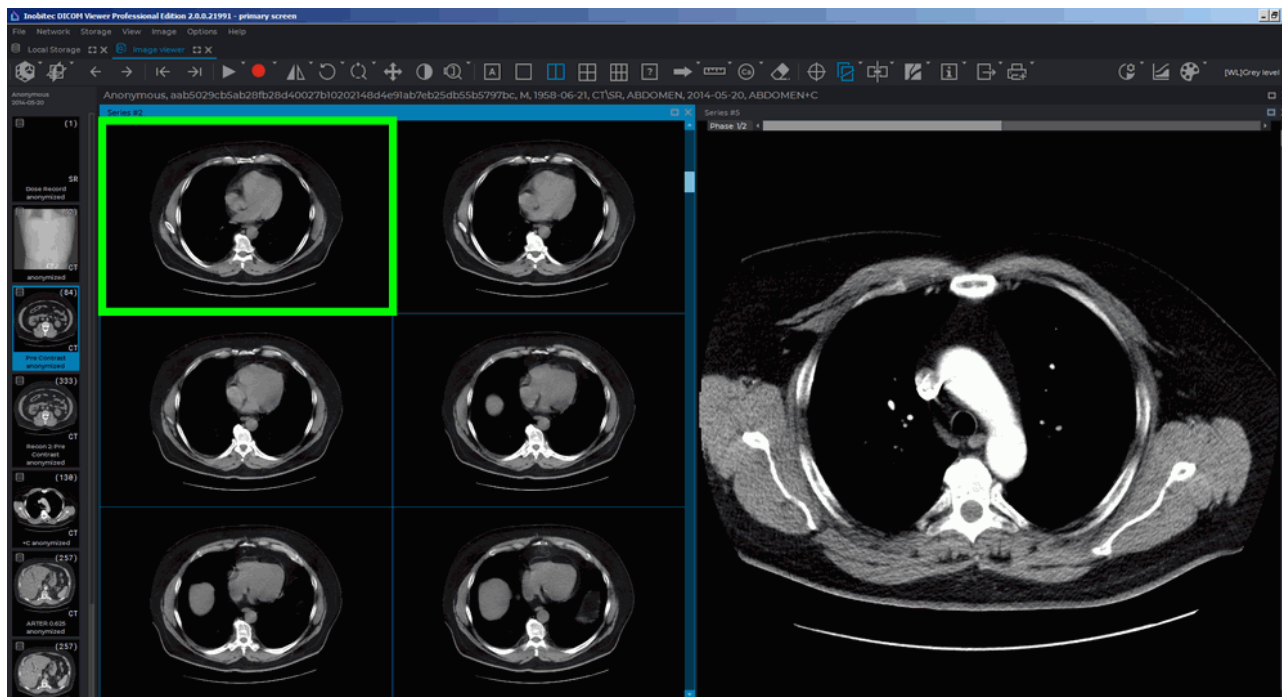



Figure 2.21: Video recording area is highlighted in green

Video recording can be synchronized with playback (see Section 2.15). To start playback when recording a video and stop it after completing a video recording, click on the arrow on the right side of the  button, select the **Settings...** item and in the dialog that opens (fig. 2.22), check the **Start playback after recording starts** box. If this box is checked then video recording will stop after the playback is stopped.

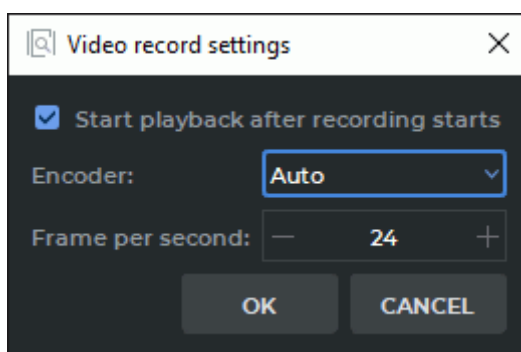

Figure 2.22: Video record settings dialog box

Chose one for the following options from the **Encoder** drop-down list:

- **Auto**. The choice of the encoder depends on the number of pixels in the window recorded. If the number of pixels (width × height) is  $\leq 9437184$ , the H264 encoder

will be used. For windows with more than 9437184 pixels, the MPEG4 encoder will be used. By default, the encoder is selected automatically;



- **H264.** The encoder is used for recording videos when the number of pixels in the window (width × height) is  $\leq 9437184$ . If the number of pixels in the window is greater, a window suggesting that the MPEG4 encoder should be selected instead will pop up when the user presses «**OK**»;
- **MPEG4.** The encoder may be used for recording videos in the windows of any size, but the resulting video file will occupy more space on a disc compared to a file created with the H264 encoder.

To set the frame rate, enter the value into the **Frame per second** field.

Click **OK** to apply the settings or **CANCEL** to cancel.

To start recording video:

1. Click on the **Start video record**  button. The file save dialog opens.
2. Select the save path and the file name.
3. To start video recording, click **Save** and to cancel, click **Cancel**.



During video recording, the button looks like  . To stop video recording, click the  button. After the video recording is completed, the **Video record was stopped** message appears.

The video will be saved in a file with *.mp4* extension.

## 2.16 Zoom. Pan. Rotate

### 2.16.1 Zoom

To zoom an image, use one of the following methods:

1. Roll the mouse wheel holding the **Ctrl** key. Roll the wheel up to zoom in or down to zoom out.
2. With the **Zoom** tool. Activate the tool by clicking on the button  and zoom the image, moving the cursor up and down. To select scale values, call the drop-down menu, clicking on the arrow on the right side of the  button and select the value. To set the scale manually, select the **Custom zoom...** item from the drop-down menu. This tool is also available from the image context menu and from the **Image** main menu item.

Images are scaled relative to the point the cursor is located at.

## 2.16.2 Pan

There are two ways to move the image in the view window:

1. Move the mouse holding the wheel and the **Shift** key on the keyboard. This key combination is set by default. You can disable or change the setting in the **Controllers** tab of the **Image viewer** module (see Section 16.7.1).
2. Activate the **Pan**  tool on the toolbar by clicking the left/right/middle mouse button. To continue work with this tool, use the button with which the tool was activated. To learn more about tool control, see Section 1.14. To move an image, move the cursor around the screen while holding down the mouse button.

This tool is also available from the image context menu and from the **Image** main menu item.

## 2.16.3 Rotate

To rotate an image by an angle multiple of 90 degrees, click on the arrow on the right side of the **Rotate**  button on the toolbar, and select one of the four options:

- Set 0°;
- Set 90° clockwise;
- Set 180°;
- Set 90° counterclockwise.

To rotate an image by an arbitrary angle, activate the **Rotate**  tool by clicking the left/right/middle mouse button. To continue work with this tool, use the button with which the tool was activated. To learn more about tool control, see Section 1.14. Rotate the image by moving the mouse while holding down the button that activated the tool. When you finish, click the **Rotate** button to deactivate the tool.

These commands are available from the image context menu. To open them, right-click on the image and select the **Rotate** item from the context menu.

This tool is also available from the image context menu and from the **Image** main menu item.

## 2.17 Set Window Level and Width

The current window level and width values are displayed in the top right-hand corner of the window. If the **Adjust W/L**  tool on the toolbar is active, these changes are made holding the button which the tool was activated. To learn more about tool control, see Section 1.14.

In the **Volume Reconstruction** tab or **Multiplanar Reconstruction** tab, you can also activate the tool from the right-click menu of the image. In the **Flat Image Viewer** tab, the tool is available in the **Image** section of the main menu. In the **Multiplanar Reconstruction** tab, the tool is available in the **MPR** section of the main menu. In the **Volume Reconstruction** tab, the tool is available in the **Volume** section of the main menu.

To change the parameters, move the mouse in the study window, holding the button which the tool was activated

- to increase the window level — down;
- to reduce the window level — up;
- to reduce the window width — left;
- to increase the window width — right.

If you haven't activated any tools with the right mouse button, you can change the window width and level by moving the mouse while holding the right button. In the **Controllers** tab of the **Image viewer** module (see Section 16.7.1), you can choose the mouse button which will be used by default to change the window parameters.

The terms «window width» and «window level» in digital images commonly refer to «contrast» and «brightness» respectively on your computer.

For certain types of tissues, the DICOM Viewer has preset width and level values. To change the width and level settings, click the arrow on the right-hand side of the **Custom W/L** button  .

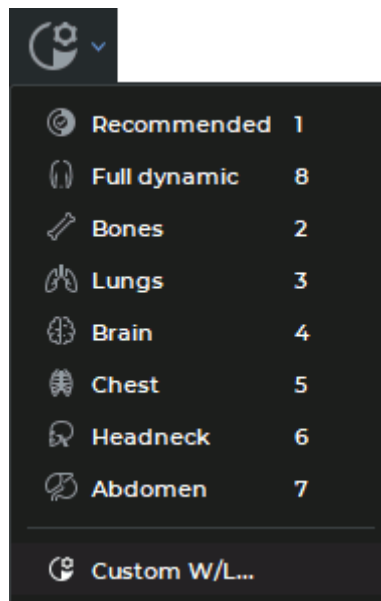



Figure 2.23: Menu of preset width and level values

The following preset values are available in the drop-down menu (see Figure 2.23):

- **Recommended** — the DICOM Viewer applies the values of the corresponding image tags. They are used by default.
- **Full dynamic** — the mode where the window width and level depends on the image parameters available. This mode is used when the window width and level is not mentioned in the study.

- **Bones** — for viewing bone tissues.
- **Lung** — for viewing lung tissues.
- **Brain** — for viewing brain tissues.
- **Chest** — for viewing chest tissues.
- **Headneck** — for viewing head and neck tissues.
- **Abdomen** — for viewing abdominal tissues.
- **Custom W/L...** — the window width and level parameters are provided by the user in the **Window Level settings** dialog box (see Figure 2.24) and are used for all the images in the series.

To select one of the modes without the preview option, click on the arrow on the right side of the  button. You cannot edit the values predefined for specific tissues. To return to the original settings, select the **Recommended** mode.

To customize the window width and level settings, click the **Custom W/L** button . In the **Window Level settings** dialog box (Figure 2.24) that pops up, provide the window width and level parameters or choose the preset values you need from the **Preset** dropdown list. On the **Preset** list, you will find standard preset values, as well as presets saved by the user earlier (see Section 2.17.2). Standard preset values are marked with icons.

In the **Window Level settings** dialog box, you will see the hotkey and the window width and level settings assigned to the selected preset.

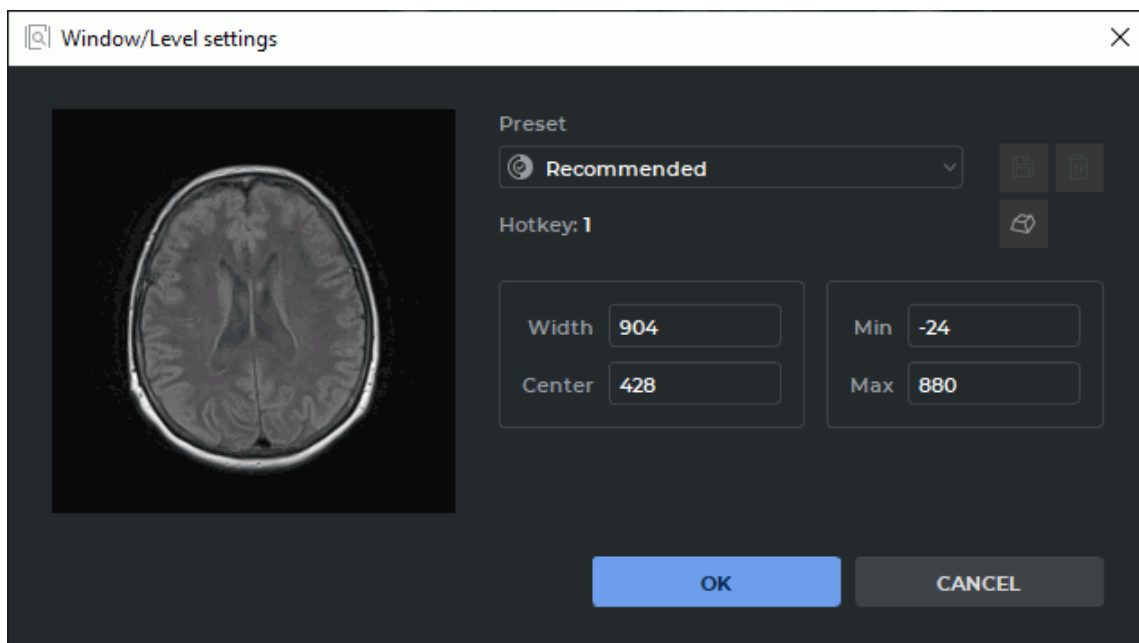

Figure 2.24: Dialog box **Window Level settings**

Click **OK** to apply the settings or **CANCEL** to cancel.

### 2.17.1 User Presets for Window Width and Level



There are two ways to create a user preset for window width and level:

1. Manually specify the values in the **Width**, **Center**, **Min** and **Max** fields of the **Window Level settings** dialog box. When a value is changed in one of the fields, the values in the other fields are changed automatically according to the following formulas:

**Width = Max — Min;**

**Center = (Max + Min)/2.**

If the window width and level settings provided are different from the existing presets, a <Custom W/L> value will be shown on the **Preset** dropdown list.

2. Change the window width and level settings with the **Adjust W/L** tool  (see Section 2.17). Open the **Window Level settings** dialog box by clicking the  button on the toolbar.

If the window width and level settings provided are different from the existing presets, a <Custom W/L> value will be shown on the **Preset** dropdown list.

To save the provided window width and level settings as a new preset, click the **Save preset**  button in the **Window Level settings** window. In the **New W/L preset** dialog box that pops up (see Fig. 2.25), provide the preset name and assign a hotkey to it. By default, the name assigned is in the *W<window width value>/L<window center value>* format, and the **Hotkey** box remains empty.

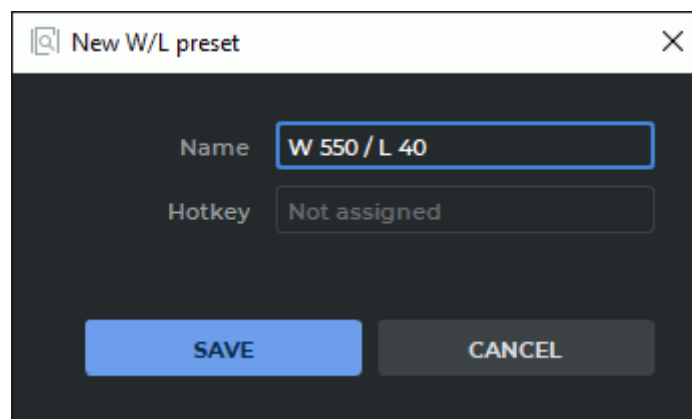

Figure 2.25: Creating a new preset



Provide a unique preset name. Assign a hotkey if required (see Section 2.17.2)

Click **SAVE** to save the preset or **CANCEL** to cancel.

After the new preset has been successfully saved, it will be shown in the **Window Level settings** dialog box.

## 2.17.2 Actions with presets

**Actions with hotkeys.** To assign or change a preset hotkey, proceed as follows:

1. Open the **Window Level settings** dialog box by clicking the  key on the toolbar.
2. Choose the preset required from the **Preset** dropdown list.
3. Click the **Set the hotkey**  button.
4. In the **Set the hotkey** dialog box that pops up (Fig. 2.26), provide a value in the **Hotkey** field. The permissible values are:
  - any single key on the alphanumeric keyboard or a function key, such as **A** or **F5**;
  - combinations of modifier keys (**Alt**, **Ctrl**, **Shift**) and alphanumeric or function keys pressed simultaneously, e.g. **Ctrl+H**, **Shift+F5**, or **Alt+Ctrl+Shift+Q**.

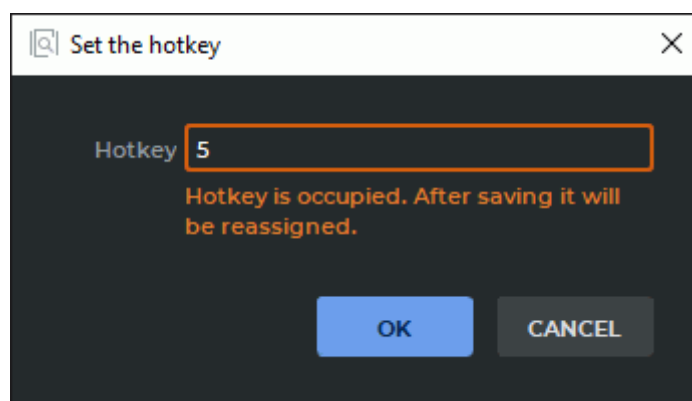

Figure 2.26: Setting up a hotkey

If the value specified in the **Hotkey** box is already assigned to another action or tool, a notification that the existing hotkey will be reassigned will appear in the dialog box. The user can also reassign hotkeys for standard window width and level settings.

5. Click «**OK**» to save the hotkey or **CANCEL** to cancel.



**When a hotkey is reassigned, the user may have to relaunch the program for the changes to take effect. If the reassigned hotkey was assigned to another W/L preset, no relaunch is required.**

**Deleting a user hotkey.** To delete a user hotkey, proceed as follows:

1. Open the **Window Level settings** dialog box by clicking the  key on the toolbar.
2. Choose the preset to be deleted from the **Preset** dropdown list.
3. Click the **Remove the preset**  button.
4. In the dialog box that pops up, click **REMOVE** to delete the preset or **CANCEL** to cancel.





**Only the presets that were created earlier by the user can be deleted. Standard presets cannot be deleted.**

After the selected preset has been deleted, the previous preset on the list will be used as the current preset. The hotkey assigned to the deleted preset will be vacant.

**User presets import and export.** Window width and level presets will be exported and imported with other program settings (see Section 16.9).

### 2.17.3 Additional Width and Level Settings

To enable additional image viewer settings, proceed as follows:

1. Choose **Settings...** in the **Options** menu.
2. Choose **Image viewer** in the **Modules** list and click the **Settings** button.
3. From the **Image viewer settings** window, go to the **W/L settings** tab (Figure 2.27).

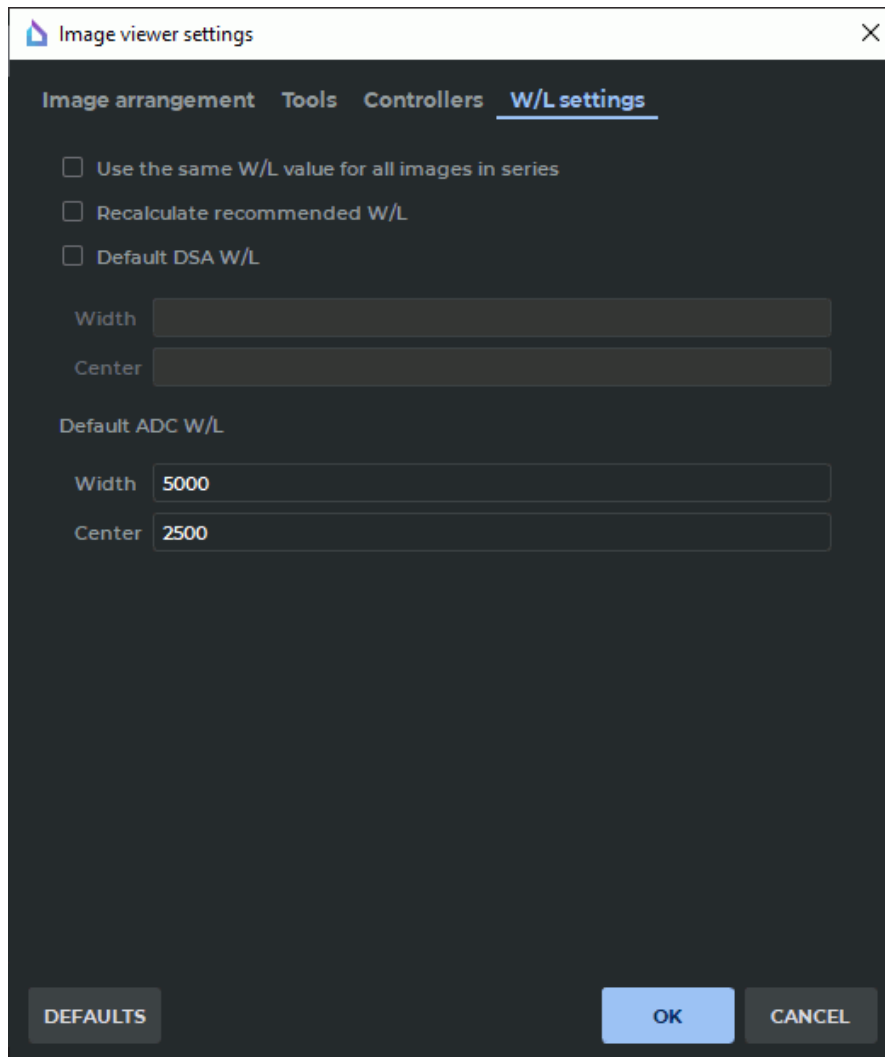

Figure 2.27: Image viewer settings dialog box

4. For the **Flat Image Viewer** mode, select the following options:

- To calculate the **Recommended** and **Full dynamic** values and apply them to all the slices in the study, check the box **Use the same W/L value for all images in Series**. If you do not select this option, the **Recommended** and **Full dynamic** values will be calculated for each image separately.
- If the window width and level values provided in the series tags are incorrect, check the box **Recalculate recommended W/L**. The recommended values are calculated on the basis of the image properties. The values provided in the series tags are ignored.
- To set the default window width and level values for the **DSA** mode, check the **Default DSA W/L**. Provide the required numerical values in the **Width** and **Center** boxes.

Click **OK** to apply the settings or **CANCEL** to cancel.

The options **Use the same W/L value for all images in Series** and **Recalculate recommended W/L** impact the window width and level values in the **Recommended** and **Full dynamic** modes.

To restore the default settings, click the **DEFAULTS** button.

### 2.17.4 Setting the Window Width and Level for Merged Series

To use the values provided in the **Window Level settings** dialog box (Figure 2.24) when viewing merged series, proceed as follows:



1. In the list of layers for the merged series, choose any except the first (base) layer. For details on series fusion, see Chapter 4. In the **Window Level settings** dialog box (Figure 2.24), provide the window width and level parameters or choose the preset values you need for this layer.
2. Open the merged series in the **Volume Reconstruction** or **Multiplanar Reconstruction** tab by pressing the respective button on the toolbar.

The width and level parameters for the first (base) layer are taken from the series tags. For the other layers, the width and level parameters are chosen by the user in the tab for merging layers.

## 2.18 Magnifier

This tool allows you to increase the tissue with a zoom increment of 2 to 32 (Fig. 2.28).

To magnify the tissue:

1. Activate the **Magnifier**  tool on the toolbar by clicking the left/right/middle mouse button. To continue work with this tool, use the button with which the tool was activated. To learn more about tool control, see Section 1.14.
2. Move the cursor to the area you want to make out.
3. The radius and the zoom increment of the tool are set on the context menu of the tool. To set these parameters, click on the arrow on the right side of the button .
4. To increase the value of the zoom increment, click the mouse button with which the tool was activated. To reduce value, click the mouse button with which the tool was activated holding down the **Alt** key on the keyboard.

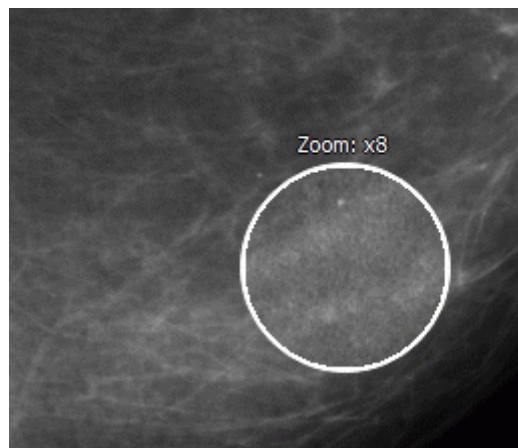

Figure 2.28: Tool **Magnifier**

## 2.19 Measurements











To avoid errors caused by the discrepancy between the image size and the real size, **Calibration tool** should be used when working with projection images (e.g. X-ray images) (see Section 2.36).



The measurement accuracy is up to one screen pixel. As a screen pixel is smaller than a source image pixel, the true linear measurement accuracy is up to one source image pixel. Errors may also occur in density measurements. The most accurate measurements are performed with **bilinear interpolation** (see Section 2.5).

The following tools are used to measure various parameters: **Ruler**, **Polygonal ruler**, **Angle**, **Cobb angle**, **Point value**, **ROI rectangle**, **ROI ellipse**, **ROI polygon**. To select one of

these tools, click on the arrow on the right side of the tool selection button. The button will look different depending on the selected tool:

	<b>Ruler</b> (selected by default)
	<b>Polygonal ruler</b>
	<b>Angle</b>
	<b>Cobb angle</b>
	<b>Point value</b>
	<b>ROI rectangle</b>
	<b>ROI ellipse</b>
	<b>ROI polygon</b>
	<b>Cardiothoracic ratio</b> <sup>PRO</sup>

To activate or deactivate the tool that is currently selected, just click on the tool selection button. If some tool is activated, the button is highlighted. The drawn objects will be displayed in the window while it is open, and you can pan, zoom or rotate them together with the image.

If the series is open in multiple windows or tabs, the measurements made in any window, appear in all the other windows.

### 2.19.1 Ruler

To measure distance in an image:

1. Activate the **Ruler**  tool on the toolbar by clicking the left/right/middle mouse button. To continue work with this tool, use the button with which the tool was activated. To learn more about tool control, see Section [1.14](#).
2. You can measure the distance in two ways:
  - Mark the first point by clicking the mouse button. Drag the cursor over the screen. The distance from the first point to the current point will be displayed beside the line. To fix the current point, click the mouse button.
  - Click on the mouse button at the starting point and move the cursor to the endpoint while holding the mouse button. The distance from the first point to the current

point will be displayed beside the line. To fix the endpoint, release the mouse button.

3. To cancel an incomplete measurement, press **Esc**.

This tool is also available from the image context menu and from the **Image** main menu item. Activation is only possible with the left mouse button.

The measurement results are not saved in the project file. To save the measurement results, export the current image to a file (see Section 2.27) or use marker lines (see Section 5.12.3).

## 2.19.2 Displaying angles between intersecting rulers

Functionality is available in the **Pro** edition

The DICOM Viewer provides an opportunity to see the base and the adjacent angle when two **Ruler**  tools cut each other in the **Image Viewer**, **MPR reconstruction**, **Vessel analysis**, **Coronary artery analysis**, **PET analysis**, and **Cardiac function analysis** tabs.

To see the angle between two intersecting **Ruler** tools, check the **Show angles between rulers**<sup>PRO</sup> box in the **Tool options** dialog box. The box is checked by default. You can choose whether only the base angle or both (the base and the adjacent) angles are to be shown (see Section 2.19.9).

The base angle between the rulers is marked with a single arc, and the adjacent angle is marked with a double arc. The angle value is shown in degrees as a separate note.

## 2.19.3 Polygonal Ruler

To perform polygonal linear measurements:

1. Activate the **Polygonal ruler**  tool by clicking the left/right/middle mouse button. To continue work with this tool, use the button with which the tool was activated. To learn more about tool control, see Section 1.14.
2. Mark the first point on the toolbar by clicking the mouse button.
3. Drag the cursor over the screen. The distance from the first point to the current point will be displayed beside the line.
4. To fix the current point, click the mouse button.
5. Repeat Steps 3 and 4 until the last but one point is fixed.
6. Fix the last point by double-clicking the mouse.
7. To cancel an incomplete measurement, press **Esc**.

To move the linear measurement point:

1. Locate the cursor on the point to be moved.

2. Drag the point, holding down the left mouse button or the button to which this tool is assigned;
3. Release the mouse button.

To delete a point:

1. Locate the cursor on the point to be deleted.
2. Right-click the mouse and select the **Remove point** command.

To insert a point:

1. Locate the cursor on the ruler where you want to insert a point.
2. Right-click the mouse and select the **Insert point** command.

This tool is also available from the image context menu and from the **Image** main menu item. Activation is only possible with the left mouse button.

The measurement results are not saved in the project file. To save the measurement results, export the current image to a file (see Section 2.27) or use polygonal marker lines (see Section 5.12.4).

### 2.19.4 Angle

To measure an angle:

1. Activate the **Angle**  tool from the toolbar by clicking the left/right/middle mouse button. To continue work with this tool, use the button with which the tool was activated. To learn more about tool control, see Section 1.14.
2. Put two points on the image, clicking the mouse button. The second point is the angle apex.
3. Move the cursor over the screen to set the other side of the angle.
4. Click the mouse button to fix the second side of the angle.
5. To cancel an incomplete measurement, press **Esc**.

The DICOM Viewer allows you to build as many angles as you need. To deactivate the tool, click on the tool selection button.

This tool is also available from the image context menu and from the **Image** main menu item. Activation is only possible with the left mouse button.

The measurement results are not saved in the project file. To save the measurement results, export the current image to a file (see Section 2.27) or use polygonal marker lines (see Section 5.12.4).

### 2.19.5 Cobb angle meter

To measure a Cobb angle:

1. Activate the **Cobb angle**  tool from the toolbar by clicking the left/right/middle mouse button. To continue work with this tool, use the button with which the tool was activated. To learn more about tool control, see Section 1.14.
2. Draw a line that runs along the border of one of the vertebrae. To do this, click the mouse button to set two points through which the line must pass.
3. Likewise, construct a line for the second vertebra.
4. To cancel an incomplete measurement, press **Esc**.

To display additional parameters, hover the mouse over the measurement tool or the measurement value. Right-click the mouse and select the **Tool options...** item from the context menu.

In the **Tool options** dialog box, provide the measurement name, as well as the color, the line width, and the font size for the angle value. To join the measurement value to the angle with a dashed line, check the **Footnote line** box.

To display the value of the adjacent angle, check the **Adjacent angle** box.

To show the angle value at the intersection of segments, check the **Show intersection** box. If this function is disabled or the segments do not intersect, the angle value is shown only at the intersection of normals. In Fig. 2.29 the option **Show intersection** is disabled, and in Fig. 2.30 is enabled.

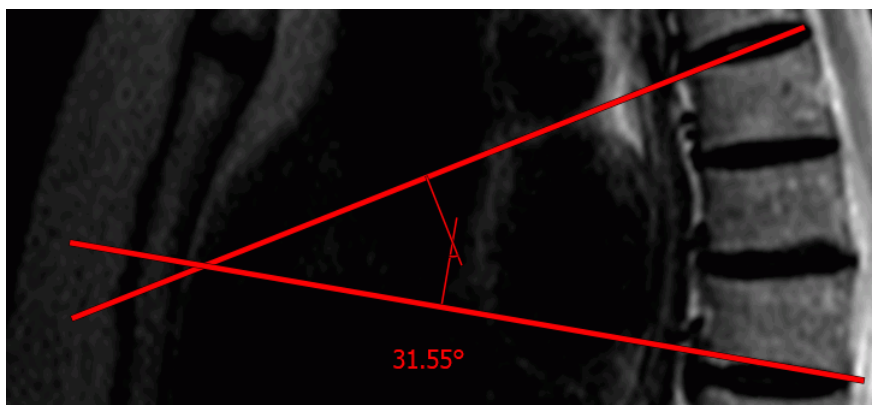

Figure 2.29: The **Show intersection** option is disabled

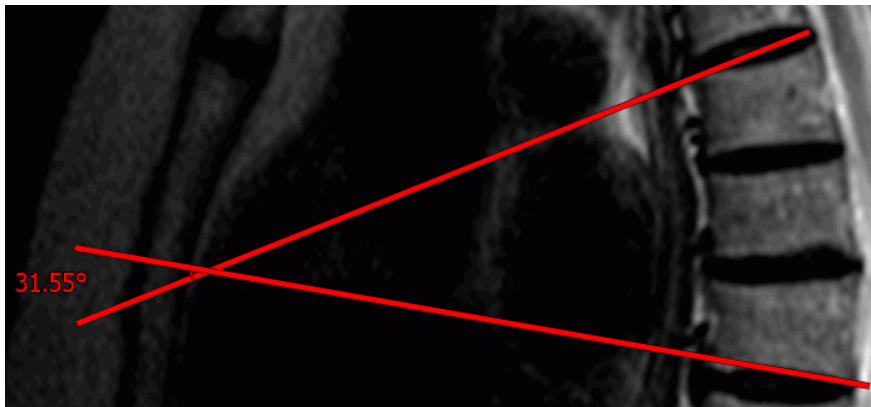

Figure 2.30: The **Show intersection** option is enabled

To use these parameters by default, check the box **Set as default**.

To apply the settings, click **OK**. To cancel, click **CANCEL**.

To delete measurement, locate the cursor on it, right-click the mouse and select the **Remove object**. For more information see Section 2.19.12.

This tool is also available from the image context menu and from the **Image** main menu item. Activation is only possible with the left mouse button.

The measurement results are not saved in the project file. To save the measurement results, export the current image to a file (see Section 2.27) or use polygonal marker lines (see Section 5.12.4).

## 2.19.6 Measure Intensity at a Point



**If non-bilinear interpolation filters are used, significant errors may occur when intensity is measured in a certain point. In this case, the intensity value will be marked by an asterisk. For more accurate measurements, use the bilinear interpolation filter (see Section 2.5).**

To measure intensity at some point:

1. Activate the **Point value**  tool from the toolbar by clicking the left/right/middle mouse button. To continue work with this tool, use the button with which the tool was activated. To learn more about tool control, see Section 1.14.
2. Click the mouse button on the target point.

The point will be highlighted at the image, and the intensity value will be displayed next to it. It is shown in the «*k HU*» format for original images and in «*k*», where *k* is the intensity value at the point. If the value is inaccurate, you will see a «\*» symbol next to it.

If you apply a filter to an image, you will see an asterisk «\*» symbol next to the intensity value. It informs the user that the measurement results are affected by the filter applied (see Section 2.6).



**An image to which a filter has been applied is not original, and the measurement results may be inaccurate.**



To adjust the **Point value** tool, locate the cursor on the point or the measurement results on the image. Right-click the mouse and select the **Tool options...** item from the context menu. In the **Tool options** dialog box enter the measurement name. Set the color and the font size. To connect the block with the measurement results with a dotted line, the **Footnote line** box must be checked. To use these parameters by default, check the box **Set as default**.

To apply the settings, click **OK**. To cancel, click **CANCEL**.



To delete measurement, locate the cursor on it, right-click the mouse and select the **Remove object**.

This tool is also available from the image context menu and from the **Image** main menu item. Activation is only possible with the left mouse button.

The measurement results are not saved in the project file. To save the measurement results, export the current image to a file (see Section 2.27).

## 2.19.7 Measure the Intensity Average and Standard Deviation in an Area

To measure the average intensity value and standard deviation in a particular area:

1. Activate one of the **ROI ...** tools (rectangle , ellipse , or polygon ) from the toolbar by clicking the left/right/middle mouse button. To continue work with this tool, use the button with which the tool was activated. To learn more about tool control, see Section 1.14.
2. You can draw a rectangle in two ways:
  - Click the mouse button to mark the first corner of the rectangle. Move the cursor to the place where the opposite corner of the rectangle should be located. The rectangle will be displayed on the screen. To fix the second corner of the rectangle, click the mouse button.
  - Click the mouse button to mark the first corner of the rectangle and move the cursor to the place where the opposite corner of the rectangle should be located while holding the mouse button. The rectangle will be displayed on the screen. To fix the point, release the mouse button.
3. To draw an ellipse, just draw the rectangle the ellipse is inscribed in.
4. To draw a polygon, click the mouse button to mark each apex and then double-click the mouse to finish.
5. To cancel an incomplete measurement, press **Esc**.

These tools are also available from the image context menu and from the **Image** main menu item. Activation is only possible with the left mouse button.

The following parameters will be displayed next to the highlighted area:

- minimum intensity value;
- maximum intensity value;
- average intensity value;
- standard deviation;

- area perimeter;
- area space.

If you apply a filter to an image, you will see an asterisk «\*» symbol in the ROI measurement results line. It informs the user that the measurement results are affected by the filter applied (see Section 2.6).



**An image to which a filter has been applied is not original, and the measurement results may be inaccurate.**

### 2.19.8 Measuring the Cardiothoracic Ratio (CTR)

---

Functionality is available in the **Pro** edition

---

To measure the cardiothoracic ratio, proceed as follows:

1. Activate the **Cardiothoracic ratio**  tool from the toolbar by clicking the left/right/middle mouse button. To continue work with this tool, use the button with which the tool was activated. To learn more about tool control, see Section 1.14.
2. Measure the thoracic diameter by marking points on the inside of the ninth rib (points 1 and 2 in Fig. 2.31).
3. Build the vertebral column axis (points 3 and 4 in Fig. 2.31).
4. Measure the transverse cardiac diameter by marking the outermost points of the left and the right contours (points 5 and 6 in Fig. 2.31).
5. To cancel an incomplete measurement, press **Esc**.

Next to the measurement, you can see the following results:

- **transverse thoracic diameter (TTD)** in millimeters;
- **transverse cardiac diameter (TCD)** in millimeters;
- **cardiothoracic ratio (CTR)** as a percentage.

This tool is also available from the image context menu and from the **Image** main menu item. Activation is only possible with the left mouse button.

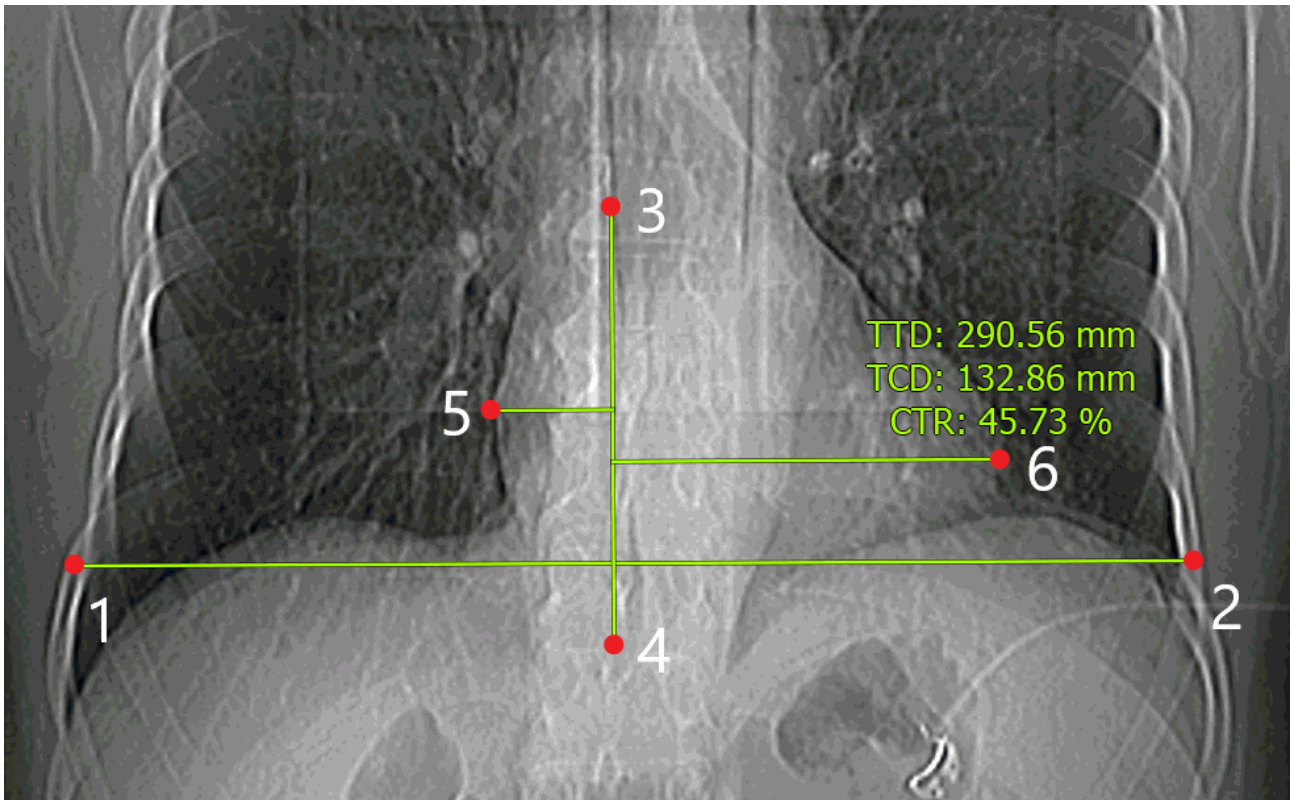

Figure 2.31: Measuring the cardiothoracic ratio

### 2.19.9 Drawing Parameters

To set the default drawing parameters for measurement tools:

1. Click on the arrow on the right side of the measurement tool selection button.
2. Select the item **Default tool options...**
3. In the dialog box that appears, set the color by clicking on the color box.
4. Set the line thickness and the font size.
5. Set length and area units (millimetres or centimetres).
6. To connect the footnote and the measurement of the dotted line, check the box **Footnote line**.
7. To see the angle between two intersecting **Ruler** tools, check the **Show angles between rulers**<sup>PRO</sup> box. The box is checked by default.
8. Choose the angle display option:
  - if you want only the base angle to be shown, chose the **Only one**<sup>PRO</sup> option;
  - if you want the base and the adjacent angles to be shown, choose the **Both (incl. adjacent angle)**<sup>PRO</sup> option. This option is selected by default.

9. To apply the settings, click **OK**. To cancel, click **CANCEL**.

Drawing parameters are available as well from the image context menu and from the **Image** main menu item.

The settings will be applied only to the measurements conducted in the flat image view window. For multiplanar reconstruction, similar settings should be saved separately.

To edit the drawing parameters of an existing measurement:

1. Locate the cursor on the measurement to highlight a line or a point.
2. Right-click the mouse.
3. Select the **Tool options...** item from the context menu.
4. In the dialog box that appears, set the parameters in the same way as the default drawing parameters.
5. To use these parameters by default, check the box **Set as default**. Set the measurement name if necessary.

### 2.19.10 Move Measurements

To move a measurement:

1. Locate the cursor on the measurement to highlight the line or point or to magnify the cross, marking the angular point. Do not locate the cursor on angle points.
2. Move the measurement, holding any mouse button.

### 2.19.11 Move Measurement Results

To move a measurement result:

1. Locate the cursor on the measurement so that it is highlighted by a dotted frame.
2. Move the measurement result, holding down the left mouse button or the button to which this tool is assigned;

If the cursor is located on the measurement, the corresponding measurement result will be highlighted, and vice versa.

### 2.19.12 Delete Measurements

To delete annotations and measurements, locate the cursor on the measurement to highlight a line or a point and press the **Delete** key on the keyboard, or right-click the mouse and select the **Remove object** item from the context menu.

To delete all annotations and measurements, click the **Delete all annotations and measurements**  button on the toolbar or select the corresponding item from the **Image** main menu. In the dialog box that appears, Click **YES** to delete or **NO** to cancel. If you want the DICOM Viewer to always delete annotations and measurements without this confirmation, check

the box **Don't show this dialog again** and click **YES**. If you want the DICOM Viewer to show the confirmation dialog, check the box **Ask before deleting all annotations and measurements** (see Section 16.7.1).



**Please note that all other graphic objects created manually will be deleted as well.**

### 2.19.13 Measuring Dimensions and Area during Ultrasound Imaging

The **Ruler**, **Polygonal ruler**, **ROI rectangle**, **ROI ellipse** and **ROI polygon** tools may be used for linear and area measurements on ultrasound images (series with **US** modality).

Ultrasound study series may contain data on the areas of images with a certain pixel size.

If measuring tools are applied to the area of the image for which the pixel size has been determined, then the measurement units provided for in the tool parameters will be used for linear and area measurements (see Section 2.19.9).

If a line or a part of the measuring area stretches beyond the area for which the pixel size has been determined, linear and area measurements will be performed in pixels.

If the series does not contain any data on the areas for which the pixel size has been determined, linear and area measurements will be performed in pixels.

### 2.19.14 Measuring the Time Interval and the Blood Flow Velocity during Ultrasound Imaging

The **Ruler** and **Polygonal ruler** tools may be used for measuring the time interval and the blood flow velocity when performing ultrasound examination (series with **US** modality) with dopplergram.



**For the Polygonal ruler tool, the values of the time interval and blood flow velocity are only shown when the measurement is made by two points.**

When measurements are performed, the measurement value is shown on the dopplergram image next to the segment built, in the **X: x s Y: y cm/s** format, where **x** is the value of the time interval in seconds (s) accurate up to hundredth; **y** is the value of the blood flow velocity in cm/s, accurate up to hundredth.

If the measurement is fully or partly performed beyond the Doppler area, the linear dimension will be shown next to the segment built. In this case, the measurement units depend on the current algorithm and program settings.

If no image areas are suitable for evaluation of the time interval and the blood flow velocity, then when a measurement is made, the linear value will be shown next to the segment built. In this case, the measurement units depend on the current algorithm and program settings.

## 2.20 Perfusion Parameters Estimation

---

Functionality is available in the **Pro** edition

---



**This function cannot be used for establishing a diagnosis**

The following series are suitable for perfusion parameters estimation:

- multiphase MR series. The minimal recommended phase number for brain perfusion parameters estimation is 40;
- multiphase CT series.

### 2.20.1 Open series in Perfusion Parameters Estimation mode

---

Functionality is available in the **Pro** edition

---



**This function cannot be used for establishing a diagnosis**

To open series in perfusion parameters estimation mode:

1. Open a series in the View Flat Images window.
2. Make sure that the series images are sorted by image position and phase (For details on how to sort images see Section 2.1).
3. Select the main menu **Image** and the **Perfusion** item.

The perfusion parameters estimation panel will be displayed on the right side of the window (Fig. 2.32)

This panel has two tabs: **General** and **Brain perfusion**. The **General** tab allows for evaluation of the parameters of general perfusion analysis for different types of tissue. The **Brain perfusion** tab is used for evaluation of the cerebral parameters of brain tissue perfusion.

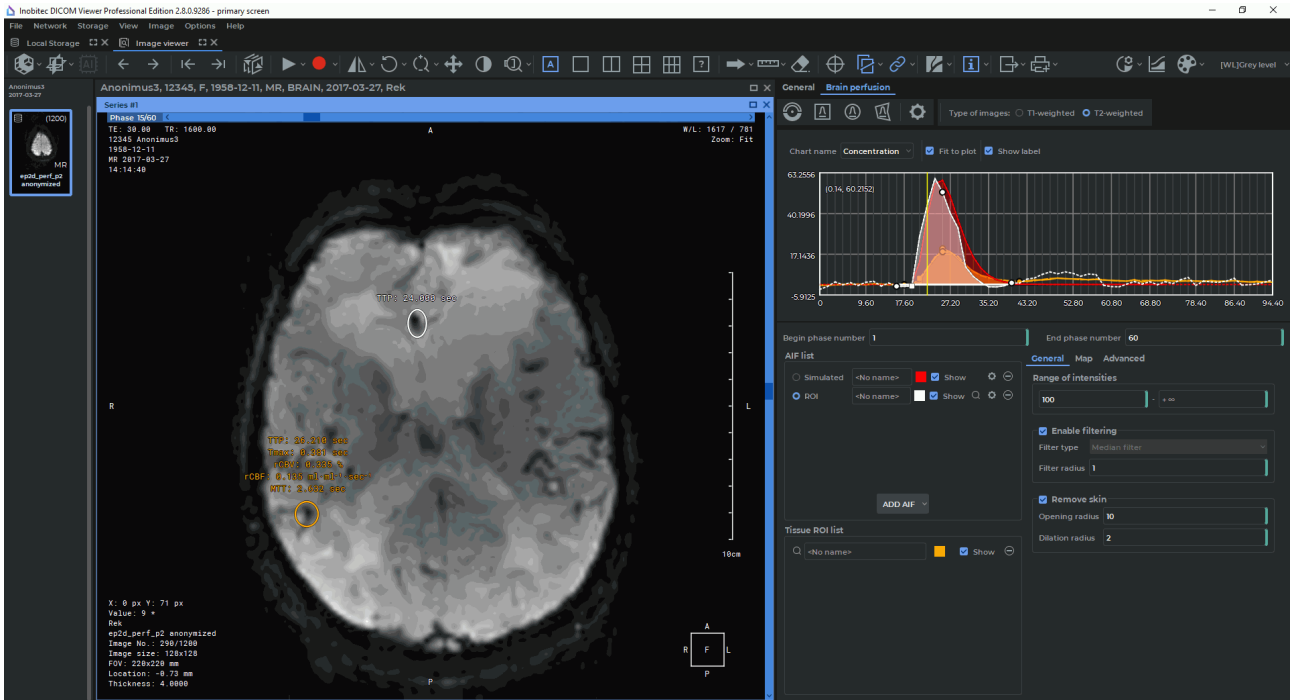

Figure 2.32: Perfusion Parameters Estimation mode

If the time interval between phases has not been set automatically, when you open the perfusion panel, you will see a dialog box (Fig. 2.33) where you need to specify the time interval between phases (see Section 2.20.2).

If the series is not suitable for Perfusion Parameters Estimation, then the **The current series don't fit in perfusion** message will be displayed on the Perfusion Parameters Estimation panel.

## 2.20.2 Setting the Time Interval on the Perfusion Panel

Functionality is available in the **Pro** edition



### This function cannot be used for establishing a diagnosis

The time interval between phases is set automatically on the basis of the DICOM tags for the series. The tags used for determining the time interval are listed below in order of priority:

- *AcquisitionDate* (0008,0022) and *AcquisitionTime* (0008,0032);
- *AcquisitionDateTime* (0008,002A);
- *FrameAcquisitionDateTime* (0018,9074);
- *ContentDate* (0008,0023) and *ContentTime* (0008,0033);
- *TriggerTime* (0018,1060).

If the time interval between phases has not been set automatically, when you open the perfusion panel, you will see a **Perfusion settings** dialog box (Fig. 2.33).

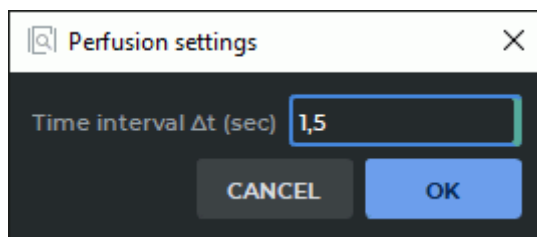

Figure 2.33: The Perfusion settings dialog box

Specify the time interval between phases in seconds in the **Time interval  $\Delta t$  (sec)** field. The value provided must be  $\geq 0,01$ . Click **OK** to proceed with perfusion parameters estimation or **CANCEL** to cancel. When you click **CANCEL**, the perfusion parameters estimation panel becomes unavailable. To make another attempt to specify the time interval, relaunch the perfusion parameters estimation panel.

To see the interval between phases, build a ROI for some tissue or a ROI AIF (see Section 2.20.3). The minimum length of a time axis segment shown in the chart is equal to the time interval between phases (Fig. 2.34).

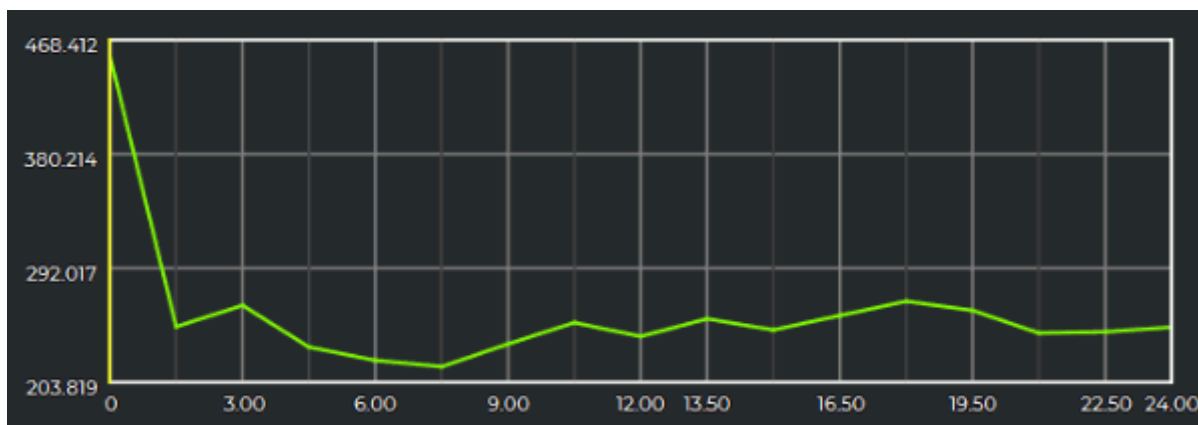



Figure 2.34: The time interval between phases as shown in the chart

To change the given time interval between phases, click the **Settings**  button on the perfusion panel. In the **Perfusion settings** dialog box (Fig. 2.33), change the current value shown in the **Time interval  $\Delta t$  (sec)** field.

After the time interval between phases has been changed, all the parameters for tissue ROI and maps are reevaluated.



### 2.20.3 Brain Perfusion Parameters Estimation

Functionality is available in the **Pro** edition



#### This function cannot be used for establishing a diagnosis

To estimate brain perfusion parameters, go to the **Brain perfusion** tab.





To add a simulated artery input function (AIF), proceed as follows:

1. Click the **Add AIF**. To create a simulated AIF, choose **Simulated** in the drop-down list.
2. Provide the following AIF parameters:
  - **Appearance time** (time before the commencement of the first bolus passage);
  - **Time to concentration peak**;
  - **Concentration peak value**;
  - **Sharpness**.



The chart shows a simulated AIF built on the basis of the stated parameters.

Click **OK** to create a simulated AIF or **Cancel** to cancel.

To create an AIF with the help of ROI:

1. Find the image that shows the artery.
2. Click the **Add AIF** button, and choose **ROI** in the drop-down list.
3. Activate one of the following tools — **ROI rectangle** , **ROI ellipse**  or **ROI polygon**  — on the perfusion parameters estimation panel with the left, right, or middle mouse button. To continue work with the same tool, use the button with which the tool was activated. For details on tool management, see Section 1.14.
4. Build ROI around the artery. Graphs of artery input function for each ROI pixel will be displayed at the bottom of the Perfusion Parameters Estimation panel. A ROI AIF graph is an averaged graph based on the graphs for the selected pixels. By default, all the pixels are selected.
5. To adjust the constructed ROI AIF, highlight several pixel graphs in ROI. To do that, select the graphs by left-clicking on them while holding the **Ctrl** key, or else you can move the mouse while holding the left mouse button. All the pixel graphs are highlighted by default. If you change the ROI, the selected pixel graphs will be reset. Click **OK** to build an AIF on the basis of the ROI, or **Cancel** to cancel.
6. To limit the interval of the phases for which the parameters are calculated, enter the numbers of the first and the last phase in the respective fields, and press **Enter** key on the keyboard. You may also move the interval limits on the chart. To do that, pause the mouse pointer on the limit so that it appears as  and move the limit while holding the left mouse button.

7. If the peak on the intensity graph is negative, you need to switch the **Type of images** to **T2-weighted** (the default value). The other value is **T1-weighted**. The **Type of images** setting is only used for MPT study series.

The AIF added will be displayed on the **AIF list** panel. If the AIF is based on a complete model, its name will start with the word «Simulated», if it is created with the help of ROI, its name will start with «ROI». To choose a name for an AIF, left-click the input box and print the name. All the AIF graphs are shown in dotted line. To apply a certain AIF, click on the respective AIF switch. To show or hide a certain AIF, check or uncheck the **Show** box. To change the pixels selected in ROI, click  **Settings** for the respective AIF. To go to the image for which the AIF was created, click  on the right-hand side of the name. To delete the selected AIF, click the  **Delete** button.

The charts may show:

- The intensity values (for AIF with ROI, tissue ROI);
- The concentration values (for all the AIF, tissue ROI);
- The response function values (for tissue ROI).

Select **Intensity**, **Concentration**, or **Response** in the drop-down list over the chart. The **Response** chart is built for tissue ROI on the basis of the data for the AIF selected.

The X-axis shows the time, while the Y-axis shows the intensity, concentration, or relative bolus concentration (depends on the chart selected).

To move the chart along the vertical axis, move the mouse up or down while holding the left mouse button and the **Shift** key. To resize the chart, move the mouse up or down while holding the left mouse button and the **Ctrl** key. If you check the **Fit to plot** box, the graph will be fitted to the window size. This box is checked by default. If you check the **Show label** box, the values will be shown in the point where the cursor is placed. This box is also checked by default.

The concentration graph for ROI objects has the following key points:

- The point showing the commencement of the bolus passage through the tissue ROI (a round point);
- The point showing the bolus peak concentration in the tissue ROI (a round point);
- The point showing the end of the first bolus passage through the tissue ROI (a round point);
- The point showing the steepest slope of the concentration curve (a square point).

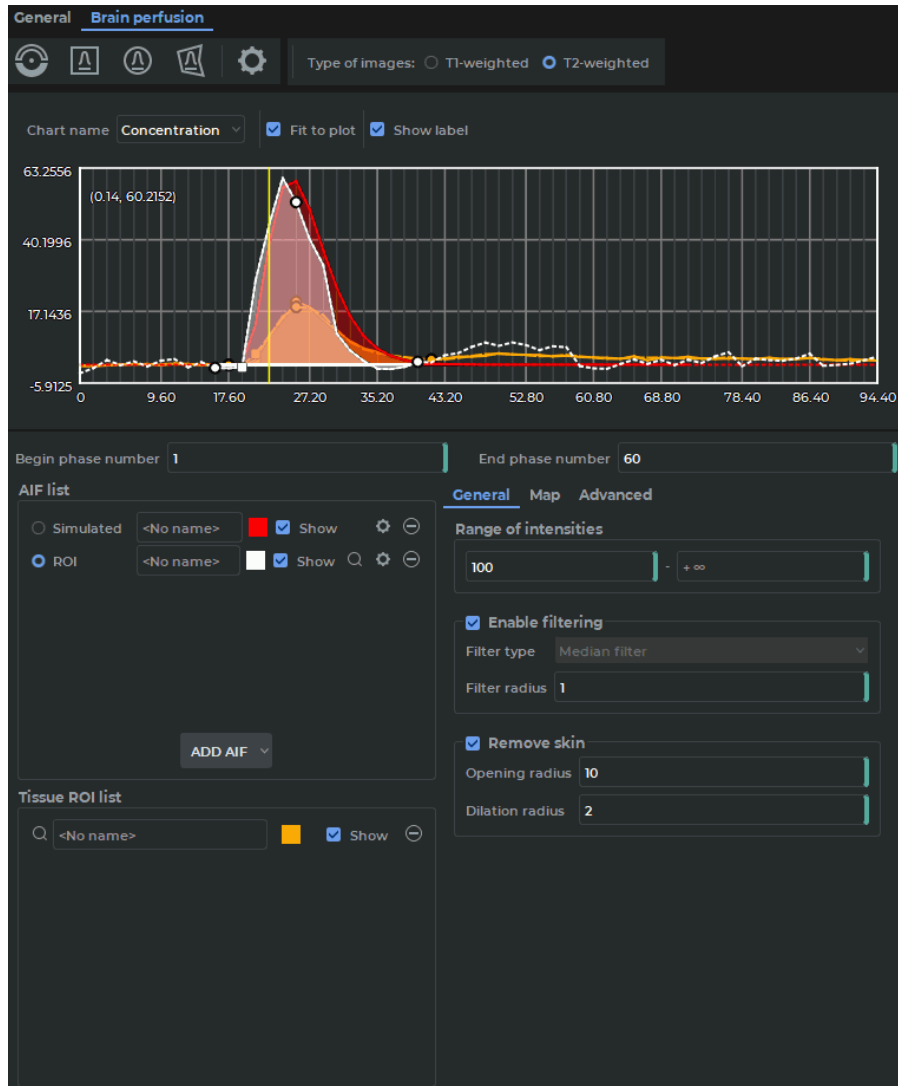





Figure 2.35: The panel **Brain perfusion**

To build a ROI for evaluating the intensity, concentration, or response values, proceed as follows:

1. Activate one of the following tools — **Point value** , **ROI rectangle** , **ROI ellipse** , or **ROI polygon**  — with the left, right or middle mouse button. To continue work with the same tool, use the button with which the tool was activated. For details on tool management, see Section 1.14.
2. Build a ROI object for the area you need.
3. Configure the settings in the **General** tab:
  - In the **Range of intensities** section, set the minimum and the maximum value of the intensity range for pixels. A pixel falls within this range if at least one of the values of the respective graph of intensities built by phases falls within this range. The following requirements must be met:

- The values provided must be integers;
- The intensity value in the left field must be smaller than the value in the right field.

The default values are from 100 to  $+\infty$  for MRI-series and from 0 to 300 for CT-series.

If the ROI does not contain any pixels falling within this range, no graph will be built for this ROI.

- In the **Enable filtering** section, you can enable/disable the use of the smoothing filter for pixel intensity distribution graphs in order to set the signal-to-noise ratio. By default, the filter is enabled.
  - Choose the type of filter in the **Filter type** drop-down list. By default, the **Median filter** is enabled. At present, only one algorithm of raw data conversion with the median filter has been implemented. The list of filters will be expanded.
  - Provide the value in pixels in the **Filter radius** field. Only integers  $\geq 1$  must be entered. The filter radius determines the degree of smoothing for the graph of intensities (the greater is the value, the higher is the degree of smoothing).

The default value of the filter radius is 1 for MRI series and 3 for CT series.

- In the **Remove skin** section, you can enable/disable the deletion of skin pixels. By default, the filter is enabled. Provide integer values in the **Opening radius** and **Dilation radius** fields. The default values are 10 for **Opening radius** and 2 for **Dilation radius**.

The ROI built will be shown on the **Tissue ROI list**.

At the top of the perfusion parameters estimation panel, the graphs depicting the changes in intensity, concentration, or response values across time are shown. These graphs are presented as a solid line. To switch between the **Intensity**, **Concentration**, and **Response** parameters, choose the value you need from the **Chart name** drop-down list.

You may perform the following actions with the study subjects (AIF with ROI, simulated AIF, or tissue ROI):

1. Rename.
2. Change a color. Click the color button to the right of the AIF or ROI name.
3. Change visibility. To make an AIF or ROI invisible, uncheck the box for the selected AIF or ROI.
4. Move the phases. If the patient moves while scanning is being performed, the tissues for which AIF and ROI are to be built are displaced, and the phases are changed. The DICOM Viewer provides an opportunity to build AIF and ROI separately for each phase. To move an AIF or ROI for the current phase, hold down the **Ctrl** key while moving; for the current and all the following phases hold down the **Shift** key; for the current and all the previous phases hold down the **Alt** key. You cannot resize the ROI for a particular phase. If you try to resize the ROI for a particular phase or phase subset, the ROI for the other phases will be resized accordingly. Tissue ROI resizing and relocation only affects the evaluation of the parameters of the selected tissue area.

5. Move to the next slice. To move an AIF or ROI to the next slice, choose **Move ROI to previous slice** or **Move ROI to next slice** in the right-click menu.
6. Remove. Click the  button for selected AIF or ROI.

To go to image containing AIF or ROI, click the  button.  
The values of the following parameters are shown for ROIs:

- **Time to peak (TTP);**
- **Cerebral blood flow (rCBF);**
- **Cerebral blood volume (rCBV);**
- **Time to peak of response (Tmax);**
- **Mean transit time (MTT).**

## 2.20.4 Map mode

Functionality is available in the **Pro** edition



**This function cannot be used for establishing a diagnosis**

To activate the map display mode, check the **Enable** box on the **Map** tab of the perfusion panel. This box is unchecked by default.

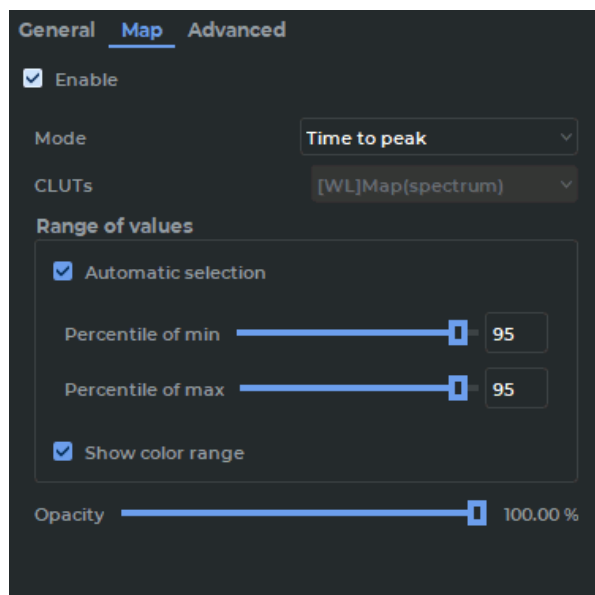

a)

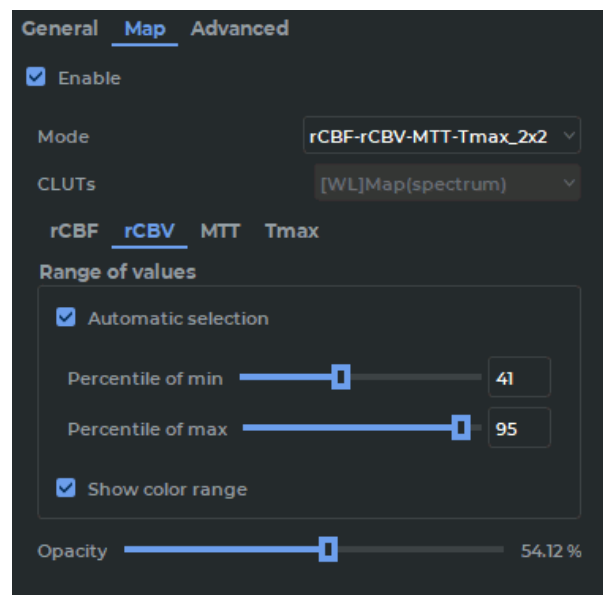

b)

Figure 2.36: The **Map** tab of the perfusion panel

In the **Mode** drop-down list, choose one of the preset map display modes. The following map display modes are available:

- **Conventional.** One map for one selected perfusion parameter is displayed in the series window. The option is shown in the **Mode** list as: *<Full parameter name>*, e.g. *Time to peak* (Fig. 2.36a);
- **Multimap.** Several maps for different perfusion parameters of the same slice are displayed simultaneously in the same window. The option is shown in the **Mode** list as: *<Short name of parameter 1>...<Short name of parameter l>\_n×m*, where  $l=n \times m$ ;  
 $n$  is the number of lines, and  $m$  is the number of columns for displaying images in the series window.  
E.g. *rCBF-rCBV-MTT-Tmax\_2x2* (Fig. 2.36b). In the **Map** tab, an additional tab bar with map parameters is displayed.

If you choose the multimap mode, maps are automatically displayed in the series window. If the multimap mode is enabled, you cannot change the arrangement of the images via the context menu. To escape from the multimap menu, choose the Conventional mode or disable the map display function by unchecking the **Enable** box in the **Map** tab.

The following modes are available for the **General** tab:

- **Time to peak;**
- **Area under curve;**
- **Maximal slope;**
- **TTP-Area-Slope\_1x3.**

If at least one AIF has been provided, the following modes are available for the **Brain perfusion** tab:

- **Time to peak;**
- **Area under curve;**
- **Maximal slope;**
- **TTP-Area-Slope\_1x3;**
- **Cerebral blood flow;**
- **Cerebral blood volume;**
- **Mean transit time;**
- **Time to peak of response;**
- **rCBF-rCBV-MTT-Tmax\_2x2.**

If no AIF has been provided, you will only be able to use the modes that are available in the **General** tab.

The following parameters are provided for a map:

- **CLUTs.** A drop-down list of color tables that determine the map color spectrum. The setting applies to all displayed maps. The «[WL]Map(spectrum)» color table is used by default. Users may create their own color tables with the **Perfusion** tag. The user's color tables are added to the drop-down list.
  
- The **Range of values** table is used for setting the minimum and maximum map values. If the **Automatic selection** box is checked, the input fields for the minimum and the maximum map value percentile ranks are displayed. The minimum percentile rank determines the percentage of pixels for which the parameter value is above the minimum range value. The maximum percentile rank determines the percentage of pixels for which the parameter value is below the maximum range value. When the percentile ranks are set, the entered values are checked. The value range for each field is from 1 to 100. The sum of the minimum and the maximum percentile ranks must be more than 100. If the entered value is invalid, then after you press **Enter** key on the keyboard, the previous valid value will be restored.  
If the **Automatic selection** box is unchecked, the input fields for the minimum and the maximum map values are displayed. The minimum and the maximum map values are shown at the beginning and the end of the color range. By default, the **Automatic selection** box is checked, with both percentile ranks at 95%.
  
- **Opacity.** By moving the slider, you can set the map opacity.

In the multimap mode, **Range of values** and **Opacity** settings are provided separately for each map for the selected parameter available in this mode. You can select a map from the tab bar (Fig. 2.36b).

When the map is activated, in the left-hand side of the window you see a color range (Fig. 2.37). Above the range, you will see the short or abbreviated name of the parameter. The parameter units are shown in parentheses.

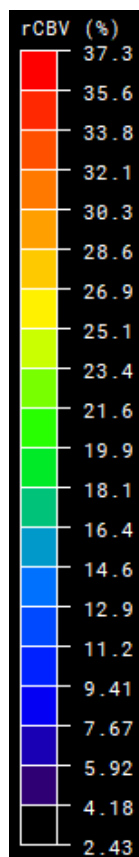



Figure 2.37: Color Range

To hide the range, uncheck the **Show color range** box on the **Range of values** panel. This box is checked by default. In the multimap mode, the range visibility is set individually for each parameter.

To change the range values, move your mouse over the upper or the lower bound, so that it looks like . Then move the bound outwards to enlarge the range or inwards to shrink it. The bound value will be displayed when moved. When you release the mouse button, the range will be adjusted and the range values will be saved. The **Automatic selection** box on the **Range of values** panel will be unchecked. In the input fields, you will see the minimum and the maximum color range values.

### 2.20.5 Advanced Settings for Bayesian Estimation Algorithm

---

Functionality is available in the **Pro** edition

---



**This function cannot be used for establishing a diagnosis**

Select the algorithm by clicking the **Bayesian estimation** radio button in the **Advanced** tab on the **Brain perfusion** panel (Fig. 2.38).



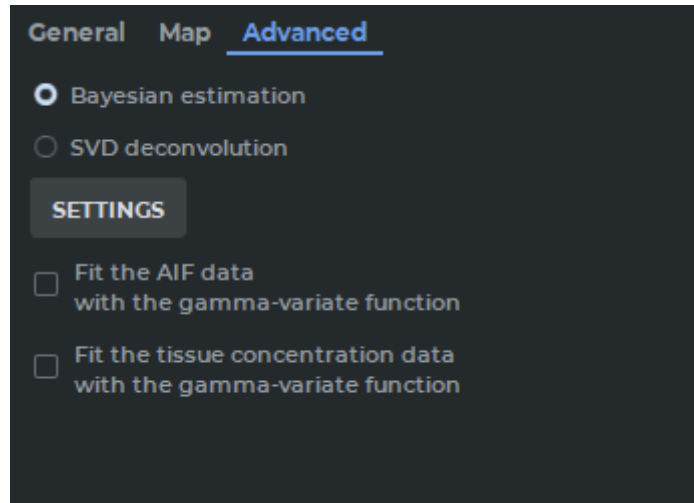

Figure 2.38: Bayesian estimation algorithm selected in the **Advanced** tab

To set the algorithm parameters, click on the **SETTINGS** button.

In the **Bayesian estimation** dialog box (Fig. 2.39) set the following parameters:

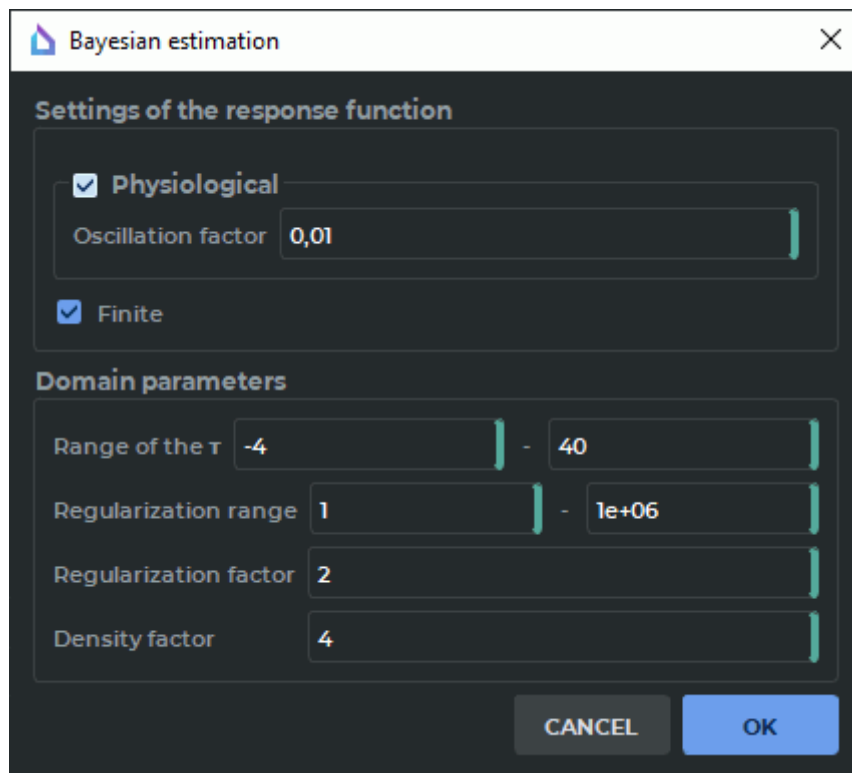

Figure 2.39: Bayesian estimation dialog box

- The section **Settings of the response function**:
  - To enable/disable oscillation amplitude regulation for the function graph, check/uncheck the **Physiological** box. Regulation is enabled by default.

- Specify the oscillation factor value in the **Oscillation factor** field. Permissible values are all non-negative real numbers. The default value is 0,01; The oscillation factor provides for the maximum permissible ratio of the oscillation amplitude value to the peak value of the response function graph. Figures 2.40 and 2.41 show response function graphs for the same ROI but different oscillation factor values.

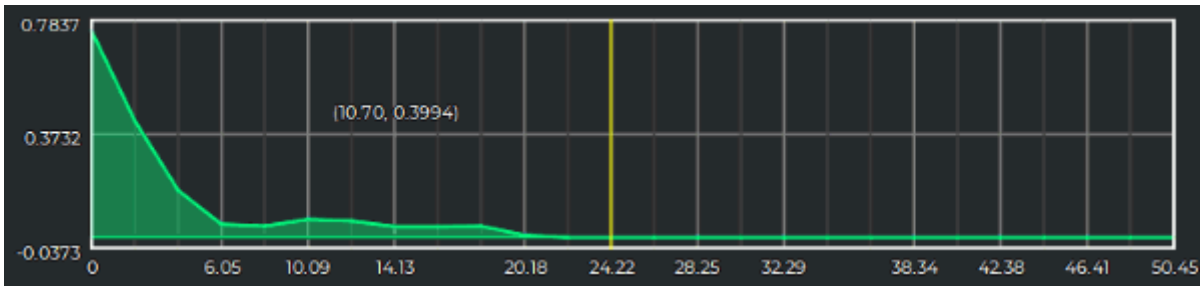

Figure 2.40: Oscillation factor 0,3

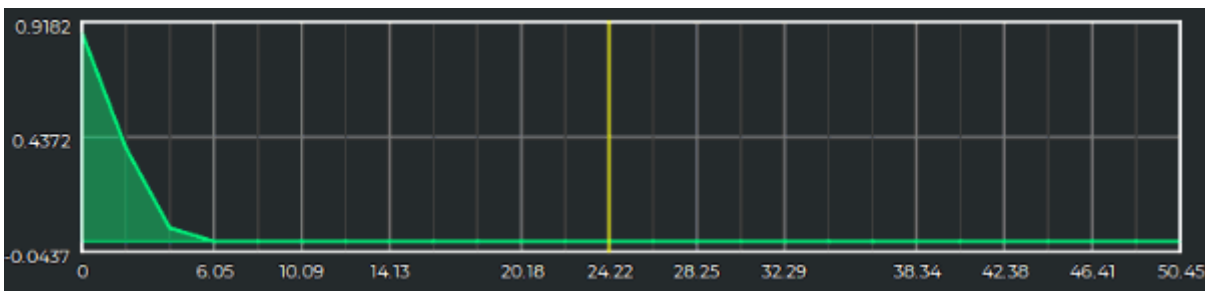

Figure 2.41: Oscillation factor 0,01

- The **Finite** option enables/disables transformations used to create response function graphs decreasing to zero over finite time after reaching the peak. The option is enabled by default. Figures 2.42 and 2.43 show response function graphs for the same ROI but different **Finite** option values.

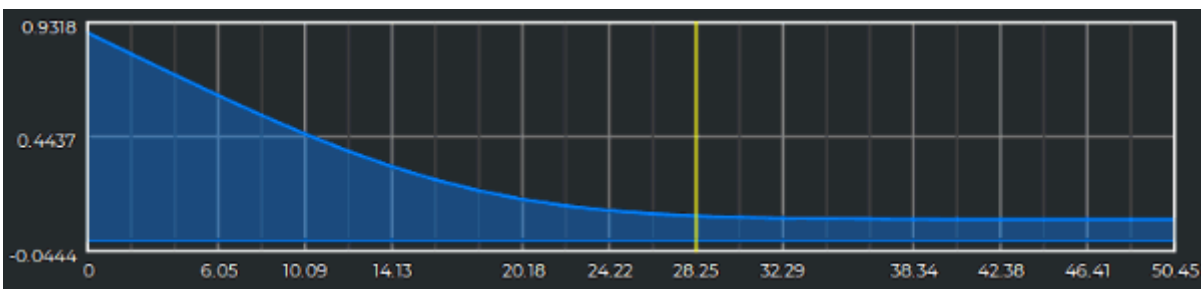

Figure 2.42: Option **Finite** is enabled

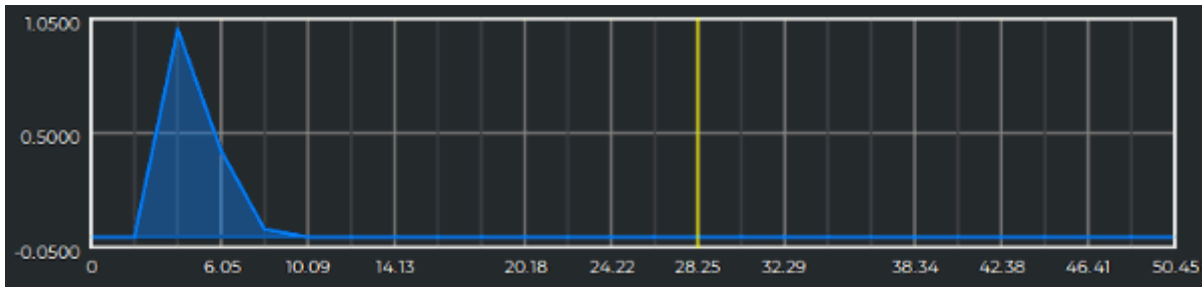

Figure 2.43: Option **Finite** is deactivated

- The following parameters are specified in the **Domain parameters** section:
  - The minimum and maximum **Range of the  $\tau$**  values. The values provided must be real numbers. The lower bound must be  $\leq -4$ , while the upper bound must be  $\geq 0$ . The default range of values is -4 to 40.
  - The minimum and maximum **Regularization range** values. The values provided must be real numbers. The minimum range value must be  $\geq 1$ . The maximum range value must comply to the following formula:

$$\ln\left(\frac{\alpha_{max}}{\alpha_{min}}\right)/(\ln\alpha_0) > 10, \quad (2.1)$$

Where  $\alpha_{max}$  is the maximum regularization range value,  
 $\alpha_{min}$  is the minimum regularization range value,  
 and  $\alpha_0$  is the regularization factor.

The default range of value is 1 to 1e6 (1000000);

- **Regularization factor**. The value provided must be a real number more than 1 and complying to the formula 2.1.  
 The default value of the regularization factor is set to 2;
- **Density factor**. The entered value must be an integer greater than 1. The default setting is 4.

Click the **OK** button to apply the algorithm settings or **CANCEL** to cancel.

If any of the parameters is changed, the following values will be reevaluated in the **Bayesian estimation** dialog box:

- Parameters for the tissue ROI provided.
- Parameters maps for rCBF, rCBV, MTT, and Tmax parameters (if a map display mode with one of the listed parameters has been set).

To enable AIF smoothing, check the **Fit the AIF data with the gamma-variate function** box. If you enable the smoothing function, the ROI and AIF graphs will be smoothed. Besides, the TTP, rCBV, rCBF, MTT, and Tmax parameters for ROI and maps will be re-evaluated. Simulated AIFs are not smoothed as they are initially built with the help of the gamma-variate function.

To enable the smoothing of concentration charts, check the **Fit the AIF tissue concentration data with the gamma-variate function** box. If you enable this function, all the concentration graphs for tissue ROI will be smoothed. Besides, the TTP, rCBV, rCBF, MTT, and Tmax parameters for ROI and maps will be re-evaluated.

In most cases, if you enable AIF or concentration graphs smoothing, it does not affect the TTP parameter value.

## 2.20.6 Deconvolution Advanced Settings

Functionality is available in the **Pro** edition



**This function cannot be used for establishing a diagnosis**

To choose a deconvolution algorithm on the basis of singular value decomposition (SVD) and set its parameters, go to the **Advanced** tab on the **Brain perfusion** panel. SVD deconvolution algorithm established by default

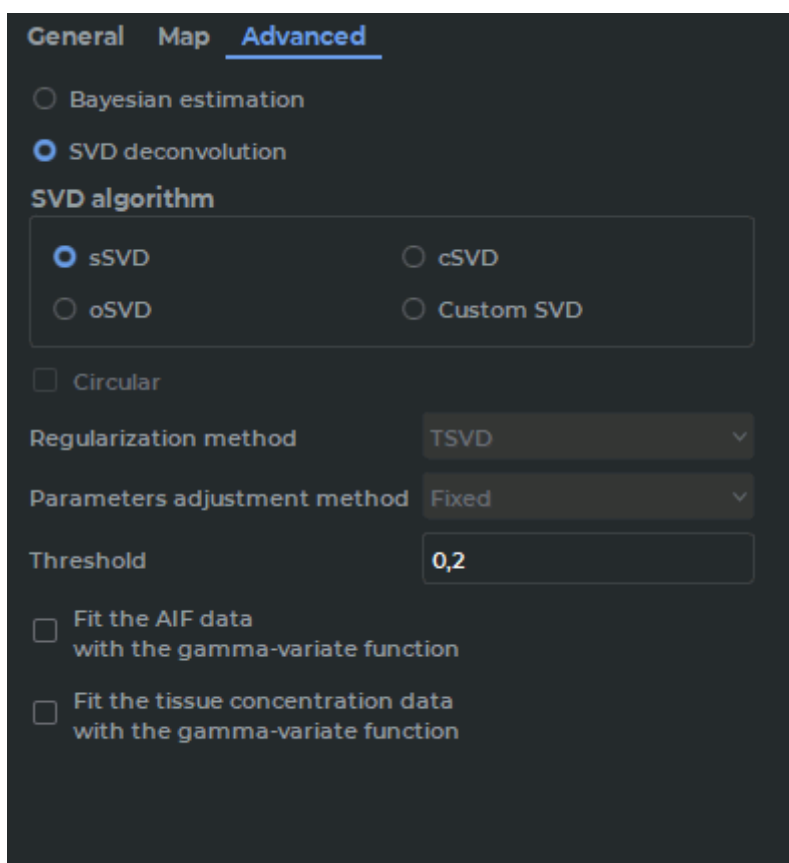

Figure 2.44: The **Advanced** tab of the perfusion panel

To apply one of the SVD deconvolution algorithms and set its parameters, click the respective option:

- **sSVD**: a non-circular algorithm. The regularization method is TSVD, the parameters adjustment method is Stationary. The threshold (the default value of 0.2) is provided as the numeric parameter.
- **cSVD**: a circular algorithm. The regularization method is TSVD, the parameters adjustment method is Stationary. The threshold (the default value of 0.2) is provided as the numeric parameter.
- **oSVD**: a circular algorithm. The regularization method is TSVD, the parameters adjustment method is the oscillation method. The oscillation index (the default value of 0.05) is provided as the numeric parameter.
- **Custom SVD** allows for setting individual combinations of regularization methods, parameters adjustment methods, and their values.

The standard **sSVD** algorithm is used by default.

To choose a circular custom algorithm, check the **Circular** box. This box is unchecked by default.

In the **Regularization method** drop-down list, choose the regularization method: **TSVD** or **Tikhonov regularization**. In the **Parameters adjustment method** drop-down list, choose the adjustment method: **Fixed** or **Oscillation method**. The threshold value or the oscillation method depends on the chosen parameters adjustment method. If you do not know what value should be provided, leave the default value. If you change the deconvolution settings, the perfusion parameters (rCBV, rCBF, Tmax, MTT) will be re-evaluated for tissue ROI and maps. The principles of work of the smoothing functions **Fit the AIF data with the gamma-variate function** and **Fit the AIF tissue concentration data with the gamma-variate function** are described in Section 2.20.5. In most cases, if you enable AIF or concentration graphs smoothing, it does not affect the TTP parameter value.

## 2.21 Evaluation of Blood Flow Parameters

---

Functionality is available in the **Pro** edition

---



### **This function cannot be used for establishing a diagnosis**

The evaluation of blood flow parameters based on phase-contrast images provides for:

- obtaining the data concerned with the blood flow velocity and volume on the basis of phase-contrast images;
- calculating the pulse-wave velocity (PWV parameter) on the basis of the data obtained.

To evaluate the blood flow parameters, you can use:

- multiphase series of magnitude images or a magnitude MRI (**MAG MRI**);
- multiphase series of phase-contrast images or a phase-contrast MRI (**PC MRI**).

## 2.21.1 Opening a Series in the Blood Flow Parameters Evaluation Mode

Functionality is available in the **Pro** edition



**This function cannot be used for establishing a diagnosis**

To evaluate the blood flow parameters, proceed as follows:

1. Open a suitable magnitude MRI (**MAG MRI**) series and the respective phase-contrast MRI (**PC MRI**) series in the flat image viewer window (Fig. 2.45). Make sure that the images have been sorted by number and phase (for details see Section 2.1). Each pair of series (**MAG MRI** and **PC MRI**) that can be used for blood flow analysis represents a separate slice.

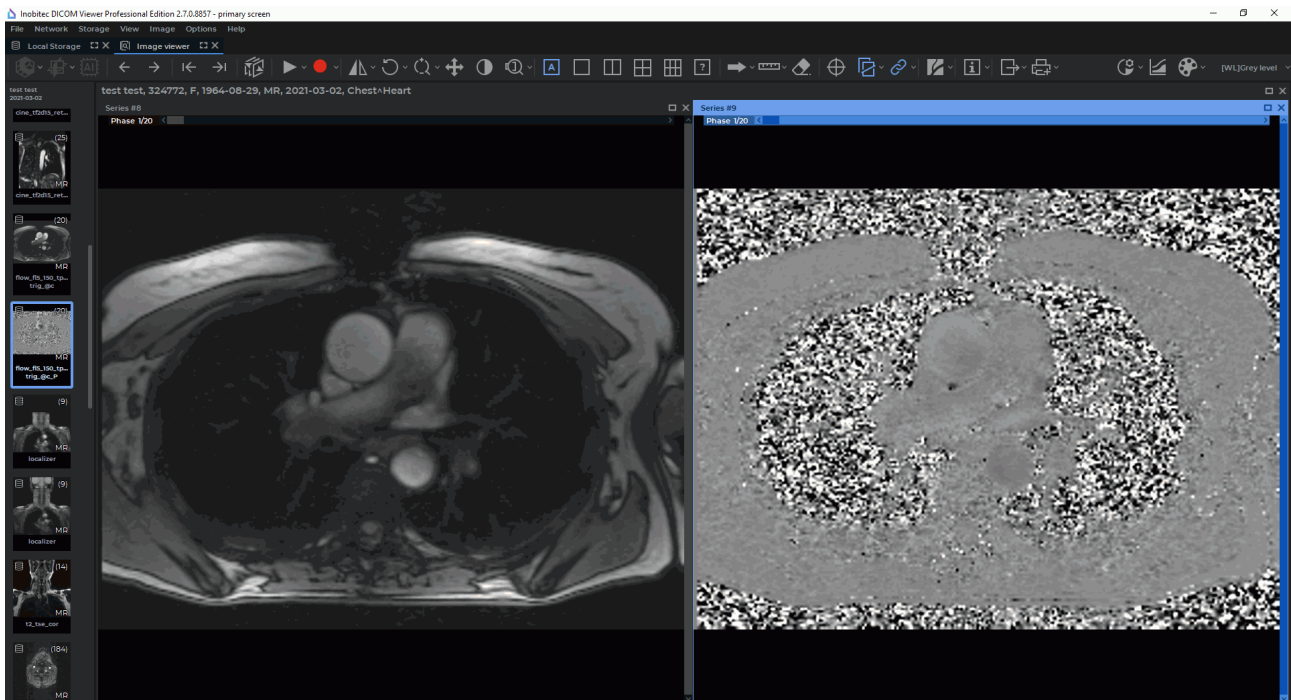



Figure 2.45: The windows for MAG MRI and PC MRI series have been opened in the flat image viewer tab

2. On the **Image** main menu, choose the  **Flow analysis** item.

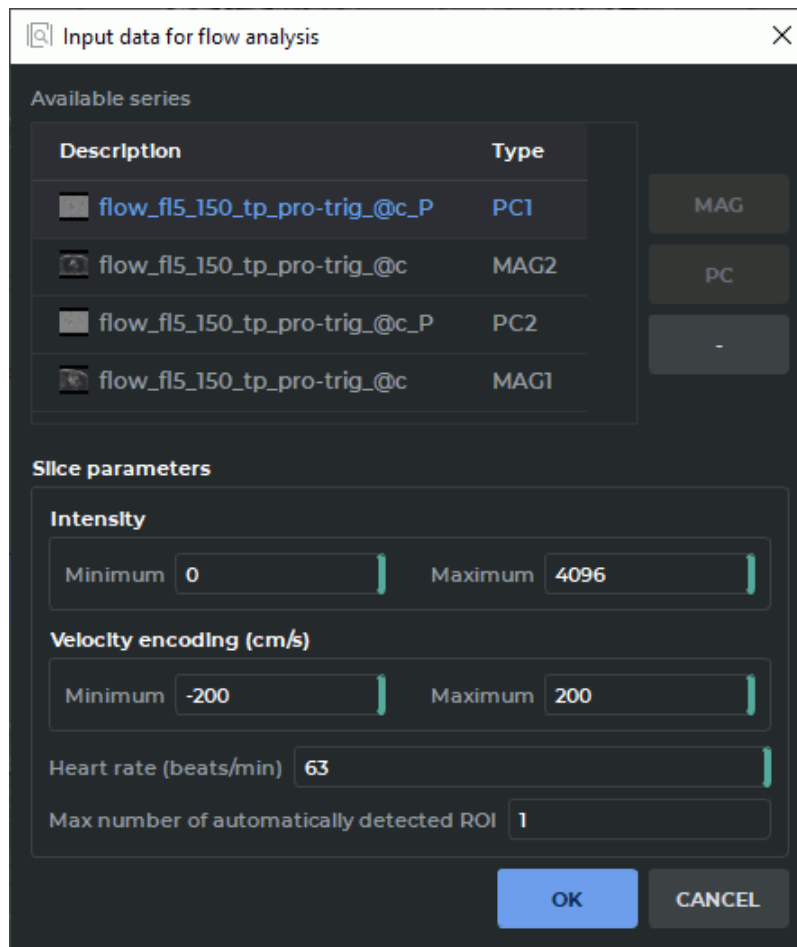

Figure 2.46: **Input data for flow analysis** dialog box

3. Provide the following parameters in the **Input data for flow analysis** dialog box (Fig. 2.46):

- the **Available series** list is automatically filled with the series that have been opened in the window of the current tab. The search and the choice of a compatible MAG MRI and PC MRI couple from the list of the series available are performed automatically. The type of each series representing one of the detected slices is specified as `<series type><slice number>`, e.g. **PC1** or **MAG1**. The values in the **Type** column are highlighted in red if:
  - One of the series (MAG MRI or PC MRI) has not been specified for the slice.
  - Not all the phase-contrast slice parameters have been provided.
  - An attempt to read the sequence of phases from the tags of a phase-contrast series has failed.

A sequence of phases is an ascending sequence of time values determined for each slice separately. The first element of the sequence is the value of the *Trigger-Time* (0018, 1060) tag of the phase-contrast series. If a value in the **Type** column is highlighted in red, an error message will pop up as a balloon tip when you mouse over this value. If a compatible pair has not been determined automatically, select the series manually.

MAG MRI and PC MRI compatibility criteria:

- the same number of phases (obligatory);
- section position and orientation compatibility (obligatory);
- the series must have the **MR** modality (recommended);
- the series must be multiphase (obligatory);
- the *Manufacturer* tag must comprise the *SIEMENS* value (recommended);
- the contents of the *ReferencedImageSequence* tag sequence must be the same (recommended);
- the *ImageType* tag must start with *ORIGINAL\PRIMARY\IP* (for PC MRI) or *ORIGINAL\PRIMARY\IM* (for MAG MRI) string expression (recommended).

When automatic search is being performed, all the listed criteria are to be taken into account; if the search is performed manually, only the obligatory criteria must be met. The series that can be selected manually do not belong to any slice (null values are assigned to such series in the **Type** column). To select a compatible pair of series manually, highlight the PC MRI series and click the **PC** button. Then select the respective MAG MRI series and click the **MAG** button. For each slice, an individual pair of PC MRI and MAG MRI series must be specified. The compatibility of the selected series must be tested according to the obligatory criteria.

In the **Type** column, specify the type in the *<series type><slice number>* format for each series representing one of the slices determined, e.g. **PC1** or **MAG1**. If the highlighted series belongs to a slice that has already been selected, then the **PC** and **MAG** buttons will be unavailable.

If the selected series does not compliance with the obligatory criteria for PC MRI and MAG MRI selection, a dialog box is displayed with a message that the selected series cannot be set as PC MRI or MAG MRI.

To delete a slice, select the series corresponding to this slice and click the « — » button. In the **Type** column, a null value is assigned to each series representing a deleted slice. If the selected series does not belong to any of the slices, the « — » button will be deactivated.

- **Slice parameters** are used to evaluate general blood flow parameters and are set automatically on the basis of PC MRI tags:
  - **Minimum and maximum intensity;**
  - **Minimum and maximum velocity encoding (cm/s).** When you specify the parameter manually, the new value is set for all the slices for which this parameter cannot be taken from the PC MRI series tags;
  - **Heart rate (beats/min);**
  - **Max number of automatically detected ROI** is used to restrict the maximum number of vessels ROI set by default when the panel is opened. As the algorithm for automatic recognition of vessel contours creates the list in the order of descending accuracy, this parameter allows for excluding odd ROI from consideration. The default value of the **Max number of automatically detected ROI** parameter is 2 (if only one slice has been selected) or 1 (if two or more slices have been selected). If the value of this parameter has not been provided, then the blood flow parameters will be estimated for all the vessels detected automatically.



Not all the required parameters may be set automatically, but only some of them. In such a case, the rest of the parameters specified in the dialog box are to be set manually.

- Click the **OK** button to provide the data for blood flow analysis. Click the **CANCEL** button to cancel the data input.

If you have not provided all the required parameters in the **Input data for flow analysis** dialog box (Fig. 2.46), the **OK** button will be inactive.

The vessels ROI that are built in the MAG MRI series window are reproduced in the PC MRI series window. The blood flow analysis panel where the obtained results for all the vessels found will be presented as graphs and tables will appear on the right-hand side of the tab (Fig. 2.47).

When one of the windows (MAG MRI or PC MRI) is closed, the blood flow analysis panel is deactivated and all the vessels, as well as the evaluation results, are deleted.

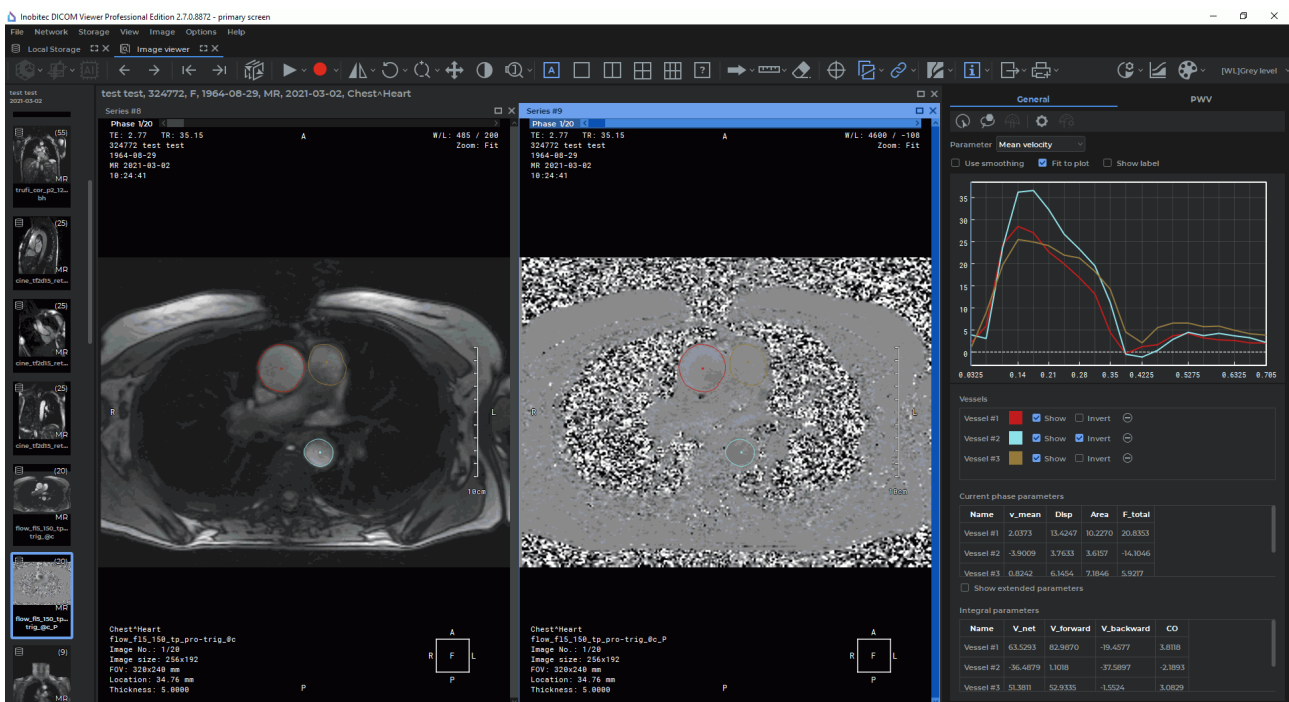

Figure 2.47: Blood flow parameters evaluation mode

On the **General** tab, general blood flow results are analyzed for each vessel detected. On the **PWV** tab advanced analysis of blood flow results is performed, which includes the calculation of additional parameters, such as: pulse wave velocity (PWV) and pulse transit time (PTT).

## 2.21.2 Changing the Configuration Parameters for a PC MRI Series

Functionality is available in the **Pro** edition



**This function cannot be used for establishing a diagnosis**

To change the configuration parameters for a PC MRI series in the process of work, click the  **PC MRI parameters** button on the blood flow analysis panel. The current values of the parameters are shown in the **PC MRI parameters** dialog box (Fig. 2.48).

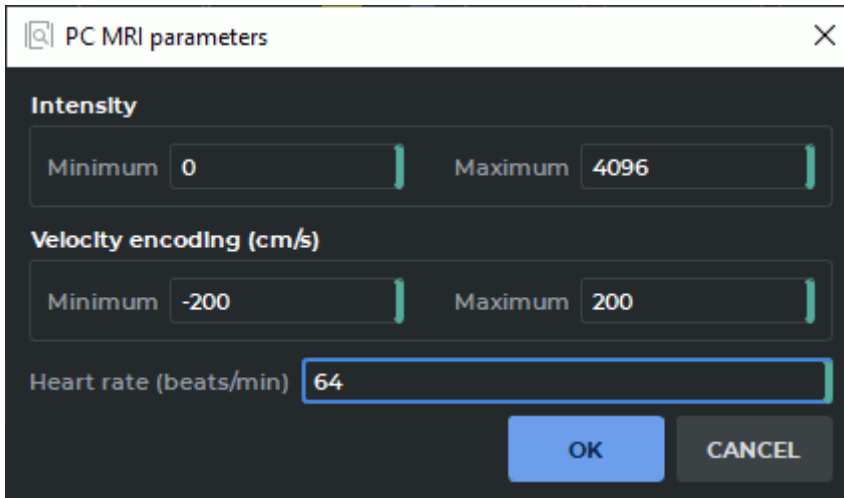

Parameter	Value
Intensity - Minimum	0
Intensity - Maximum	4096
Velocity encoding (cm/s) - Minimum	-200
Velocity encoding (cm/s) - Maximum	200
Heart rate (beats/min)	64

Figure 2.48: The dialog box for changing the PC MRI parameters

Change the values of the parameters. If you have not provided all the required parameters in the **PC MRI parameters** dialog box, the **OK** button will be inactive.

To reevaluate the blood flow parameters for all the vessels considered, click the **OK** button. To cancel, click the **CANCEL** button.

## 2.21.3 Building and Editing Vessels ROI

Functionality is available in the **Pro** edition



**This function cannot be used for establishing a diagnosis**

To evaluate general blood flow parameters for each of the vessels detected, go to the **General** tab.

To add ROI for the vessels that have not been included in the list by default, proceed as follows:

1. With the left, right or middle mouse button, activate the  **Detect vessel ROI by point** tool on the panel for blood flow parameters evaluation. Use the same button to work with the tool. For details on working with tools, see Section 1.14.





**Attention! The tool works only in the MAG MRI window selected in the “Input data for flow analysis” dialog box (Fig. 2.46). If you choose a window from a different series, you will be notified that the tool is not available for the window selected.**

2. Click on a magnitude image (MAG MRI), at a point where you expect to find a vessel. The ROI for the vessel detected will be built for all the phases, with consideration for the position and the size of the vessel section in each phase. A new vessel will be added to the list placed on the blood flow parameters evaluation panel, and the parameters evaluated will be presented as graphs and tables. If no vessel ROI is detected in the point specified, you will be notified that there is no vessel ROI at this point.

The  **Detect vessel ROI by point** tool may be used for restoring the vessels that were deleted earlier.

To build or edit a vessel ROI with contour lines, proceed as follows:

1. With the left, right or middle mouse button, activate the  **Vessel ROI (contour)** tool on the panel for blood flow parameters evaluation. Use the same button to work with the tool. For details on working with tools, see Section 1.14.
2. Press and hold the mouse button to create a contour. Release the button to finish the process and to close the contour. A new vessel will be added to the list placed on the blood flow parameters evaluation panel, and the parameters evaluated will be presented as graphs and tables.

The  **Vessel ROI (contour)** tool provides an opportunity to edit the ROI of automatically detected vessels.

On the **PWV** tab, the **Vessel ROI (contour)** tool is only available for editing vessels ROI.

Edit the ROI for each phase. The following editing methods are available:

- **changing the ROI shape.** o change the ROI shape, mouse over the contour of the ROI to be edited. The ROI contour line will be highlighted. Press the mouse button at the point where you want to edit the contour and draw a new line while holding the button. Release the mouse button to finish the editing process. All the blood flow parameters for the vessel will be reevaluated. Press **Esc** on your keyboard while still holding the mouse button to cancel the building or editing operations for the current contour;
- **moving the ROI.** o move a ROI, mouse over the contour of the ROI to be moved. Move the mouse while holding the mouse button and the **Shift** key on the keyboard.

## 2.21.4 Blood Flow Analysis Panel. Displaying the Results of General Blood Flow Analysis

Functionality is available in the **Pro** edition



**This function cannot be used for establishing a diagnosis**

On the **General** tab, general blood flow results are analyzed for each vessel detected. The results of general blood flow analysis are presented as graphs and tables.

On the coordinate plane (Fig. 2.49) graphical data for the parameter selected from the drop-down list are presented:

- **Mean velocity;**
- **Velocity dispersion;**
- **Area;**
- **Total flow.**

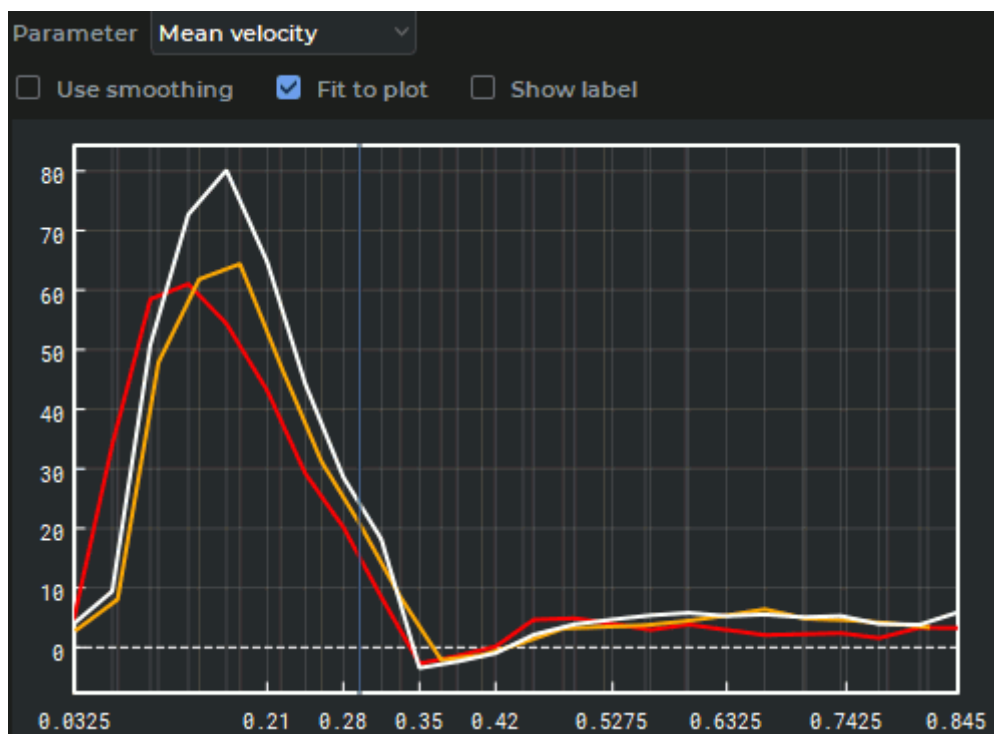

Figure 2.49: Mean velocity parameters graphs for the vessels detected

The time values are shown on the x-axis, while the values of the parameter chosen from the drop-down list are shown on the y-axis. The range of values for the time axis is formed by combining the phase sequences for all the slices. The resulting sequence does not contain

any matching values and is sorted in ascending order. The current phase position is marked by a blue slider. In the series window, the phase that is the closest to the time value marked by the slider on the graph is selected as the current phase. To change the current phase, mouse over the slider so that the cursor is displayed as  $\leftrightarrow$ . While holding the left mouse button, move the slider to the right or to the left. When you move the slider, the current phase is changed in PC MRI and MAG MRI windows. When you change the current phase, the results presented in the **Current phase parameters** table are also changed (Fig. 2.51).

To move the graph along the y-axis, move the mouse up and down while holding the left mouse button and the **Shift** key on the keyboard. To scale the graph, move the mouse up and down while holding the left mouse button and the **Ctrl** key on the keyboard.

To smooth the graphical data by cubic spline interpolation, check the **Use smoothing** box. By default, this option is disabled. The **Fit to plot** box is used to adjust the graph to the size of the window. The box is checked by default. The **Show label** box is used to show the position of the point where the cursor is placed. By default, this option is disabled.

The **Vessels** table (Fig. 2.50) is used to adjust the display settings for the vessels ROI and graphs. The table shows the number of the slice with the vessel. When you mouse over a cell with a slice number, a balloon tip with the basic data on the slice pops up.

Vessel #	Slice #	Color	Show	Invert	Delete
Vessel #1	Slice #2	Red	<input checked="" type="checkbox"/>	<input type="checkbox"/>	⊖
Vessel #5	Slice #1	Orange	<input checked="" type="checkbox"/>	<input checked="" type="checkbox"/>	⊖
Vessel #2	Slice #2	White	<input checked="" type="checkbox"/>	<input checked="" type="checkbox"/>	⊖

Figure 2.50: The **Vessels** table on the blood flow analysis panel

You can perform the following actions with the settings for vessels ROI and graphs:

- **renaming.** Double-click on the name of the vessel with the left mouse button. Type the new name and press **Enter** on the keyboard. The new name of the vessel will be shown in the respective cells of the tables displaying the blood flow parameters;
- **changing the color.** Click on the color icon next to the name of the vessel and select the color in the dialog box. The color icon, the ROI contours for all the phases, and the graphs for the selected vessel will be changed accordingly;
- **adjusting visibility.** To hide/show the ROI contours for all the phases, as well as the graphs for the selected vessel, tick/untick the **Show** box;
- **inverting the graph.** To invert the graph values (reverse the sign), check the **Invert** box. By default, this box is only checked for the vessels with backward blood flow volume. The graph values are inverted for **Mean velocity** and **Total flow** parameters;
- **deleting.** To delete a selected vessel, click the  button. All the data for this vessel will be deleted: the ROI for all the phases, the graph and the evaluation results from the tables, the blood flow parameters.

The deleted vessel may be restored with the  **Detect vessel ROI by point** tool (see Section. 2.21.3).

In the **Current phase parameters** table (Fig. 2.51), you will find the basic blood flow parameters:

- **Mean velocity (v\_mean);**
- **Velocity dispersion (Disp);**
- **Area;**
- **Total flow (F\_total).**

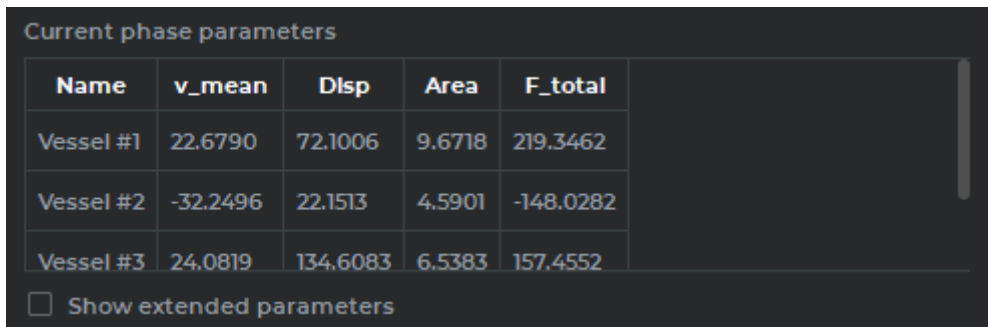

Name	v_mean	Disp	Area	F_total
Vessel #1	22.6790	72.1006	9.6718	219.3462
Vessel #2	-32.2496	22.1513	4.5901	-148.0282
Vessel #3	24.0819	134.6083	6.5383	157.4552

Show extended parameters

Figure 2.51: The **Current phase parameters** table on the blood flow analysis panel

Tick the **Show extended parameters** box to display the following additional parameters in the table:

- **Min velocity (v\_min);**
- **Max velocity (v\_max);**
- **Positive flow (F\_positive);**
- **Negative flow (F\_negative).**

The parameters shown in the **Current phase parameters** table are time-dependent and change with the current phase.

In the **Integral parameters** table (Fig. 2.52), the values of the following parameters are shown:

- **Net volume (V\_net);**
- **Forward volume (V\_forward);**
- **Backward volume (V\_backward);**
- **Cardiac output (CO).**

These parameters are not time-dependent and do not change with the current phase.

Integral parameters				
Name	V_net	V_forward	V_backward	CO
Vessel #1	63.5293	82.9870	-19.4577	3.8118
Vessel #2	-36.4879	1.1018	-37.5897	-2.1893
Vessel #3	51.3811	52.9335	-1.5524	3.0829

Figure 2.52: The **Integral parameters** table on the blood flow analysis panel

### 2.21.5 Evaluating the General Blood Flow Analysis Parameters

Functionality is available in the **Pro** edition



**This function cannot be used for establishing a diagnosis**

The following parameters are calculated while performing general blood flow analysis:

- **Phase parameters:**

- **Mean velocity** ( $v_{mean}$ , measured in cm/s). This parameter is calculated as the mean value for all the velocity values evaluated for each point of the ROI. The velocity for a particular ROI point is calculated according to the formula below:

$$V_k = VENC_{min} + \frac{(I_k - I_{min})}{(I_{max} - I_{min})} * (VENC_{max} - VENC_{min}), \quad (2.2)$$

where  $V_k$  is the velocity at the  $k$ -th point of ROI;

$I_k$  is the intensity value at the  $k$ -th point of ROI;

$I_{min}$  is the minimum intensity for the series;

$I_{max}$  is the maximum intensity for the series;

$VENC_{min}$  is the minimum velocity encoding value;

$VENC_{max}$  is the maximum velocity encoding value;

- **Velocity dispersion** ( $Disp$ ). This parameter is calculated as the velocity variance for each point of the ROI;
- **Area** ( $Area$ , measured in  $cm^2$ ). This parameter is calculated as the area of the ROI;
- **Total flow** ( $F_{total}$ , measured in ml/s). The value is calculated according to the formula below:

$$F_{total} = v_{mean} * Area \quad (2.3)$$

- **Min velocity** ( $v_{min}$ , measured in cm/s). The value is calculated as the minimum velocity among all the points of the ROI;
- **Max velocity** ( $v_{max}$ , measured in cm/s). The value is calculated as the maximum velocity among all the points of the ROI;
- **Positive flow** ( $F_{positive}$ , measured in ml/s). The value is calculated according to the formula below:

$$F_{positive} = v_{mean\ positive} * Area_{positive} \quad (2.4)$$

where  $v_{mean\ positive}$  is the mean velocity for all the ROI points with positive velocity values,

$Area_{positive}$  is the area of all the points with positive velocity values;

- **Negative flow** ( $F_{negative}$ , measured in ml/s). The value is calculated according to the formula below:

$$F_{negative} = v_{mean\ negative} * Area_{negative} \quad (2.5)$$

where  $v_{mean\ negative}$  is the mean velocity for all the ROI points with negative velocity values,

$Area_{negative}$  is the area of all the points with negative velocity values;

• **Integral parameters:**

- **Net volume** ( $V_{net}$ , measured in ml). The value is calculated according to the formula below:

$$V_{net} = \int_{t_0}^{t_n} F_{total} dt \quad (2.6)$$

where  $F_{total}$  is the blood flow,

$t_0$  is the time of the first phase,

$t_n$  is the time of the last phase;

- **Forward volume** ( $V_{forward}$ , measured in ml). The value is calculated according to the formula below:

$$V_{forward} = \int_{t_0}^{t_n} F_{positive} dt \quad (2.7)$$

where  $F_{positive}$  is the positive blood flow,

$t_0$  is the time of the first phase,

$t_n$  is the time of the last phase;

- **Backward volume** ( $V_{backward}$ , measured in ml). The value is calculated according to the formula below:



$$V_{backward} = \int_{t_0}^{t_n} F_{negative} dt \quad (2.8)$$

where  $F_{negative}$  is the negative blood flow,

$t_0$  is the time of the first phase,

$t_n$  is the time of the last phase;

- **Cardiac output** ( $CO$ , measured in l/min). The value is calculated according to the formula below:

$$CO = V_{net} * HR \quad (2.9)$$

where  $V_{net}$  is the blood flow volume,

$HR$  is the heart rate.

## 2.21.6 Designing a Trajectory for the Pulse Wave

Functionality is available in the **Pro** edition



**This function cannot be used for establishing a diagnosis**

You need to build a trajectory for the pulse wave to calculate the **Pulse wave travel distance** auxiliary parameter, which is used for **Pulse wave velocity** parameter evaluation.



**Attention! To build the pulse wave trajectory, the study must contain a sagittal plane series.**

If there is no sagittal plane series in the study, but the pulse wave travel distance is known, it can be entered manually by the user in the **PWV settings** dialog box (Fig. 2.53). For details see Section 2.21.7.

To design a pulse wave trajectory, proceed as follows:

1. Open the **MAG MRI** and **PC MRI** series in the blood flow parameters evaluation mode (for details see Section 2.21.1).
2. Open a sagittal plane study series. To simplify the process of building the trajectory, we advise you to enable the display of scout lines in the selected window (see Section 2.25).
3. Go to the **PWV** tab. When you first click on the **PWV** tab the **PWV settings** dialog box is displayed (Fig. 2.53).



**Any two sections of the same vessel placed on the same slice or on different slices may be selected as the input and output vessels. The vessel characterized by a smaller time to peak value of the blood flow graph is selected as the input vessel. If the time to peak values are the same for both vessels, the one placed higher on the Vessels table is selected as the input vessel. The PWV tab will be available after such a pair of vessels has been found.**

4. In the **PWV settings** dialog box (Fig. 2.53), you will see the list of the series opened in the current study window, except for those that have been selected as the PC MRI and MAG MRI. Select a sagittal plane study series.

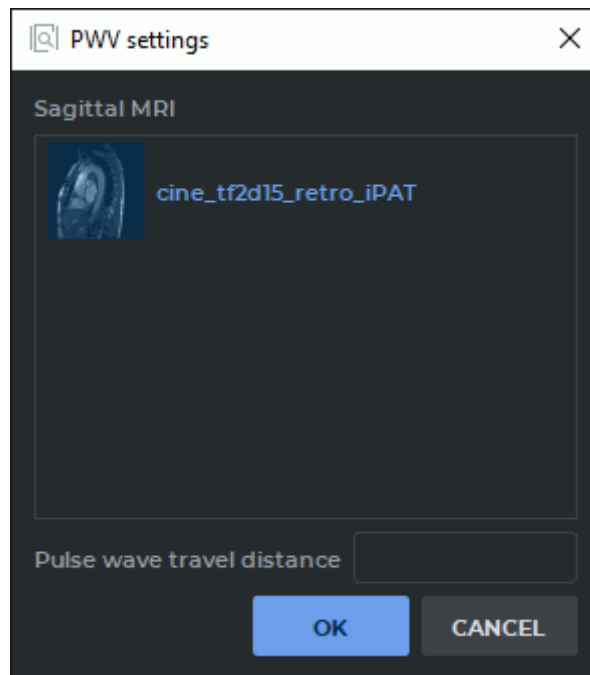



Figure 2.53: The **PWV settings** dialog box

To proceed with building the pulse wave trajectory, click the **OK** button, to go back to the **General** tab, click **CANCEL**.

If you have not chosen a series from the **Sagittal MRI** list or entered the pulse wave travel distance value (for details see Section 2.21.7), the **OK** button will be disabled.

5. Activate the  **Pulse wave travel path** tool on the panel for blood flow parameters evaluation with the left, right, or middle mouse button. Use the same button to work with the tool. For details on working with tools, see Section 1.14.



**Attention!** The «Pulse wave travel path» tool may only be activated may if the current tab is the «PWV» tab.

6. Press and hold the mouse button to build the trajectory. Release the button to finish the process. The trajectory must connect the two different slices of the vessel (Fig. 2.54). The pulse wave trajectory is smoothed to fend off aliasing which causes lengthening of the curve.

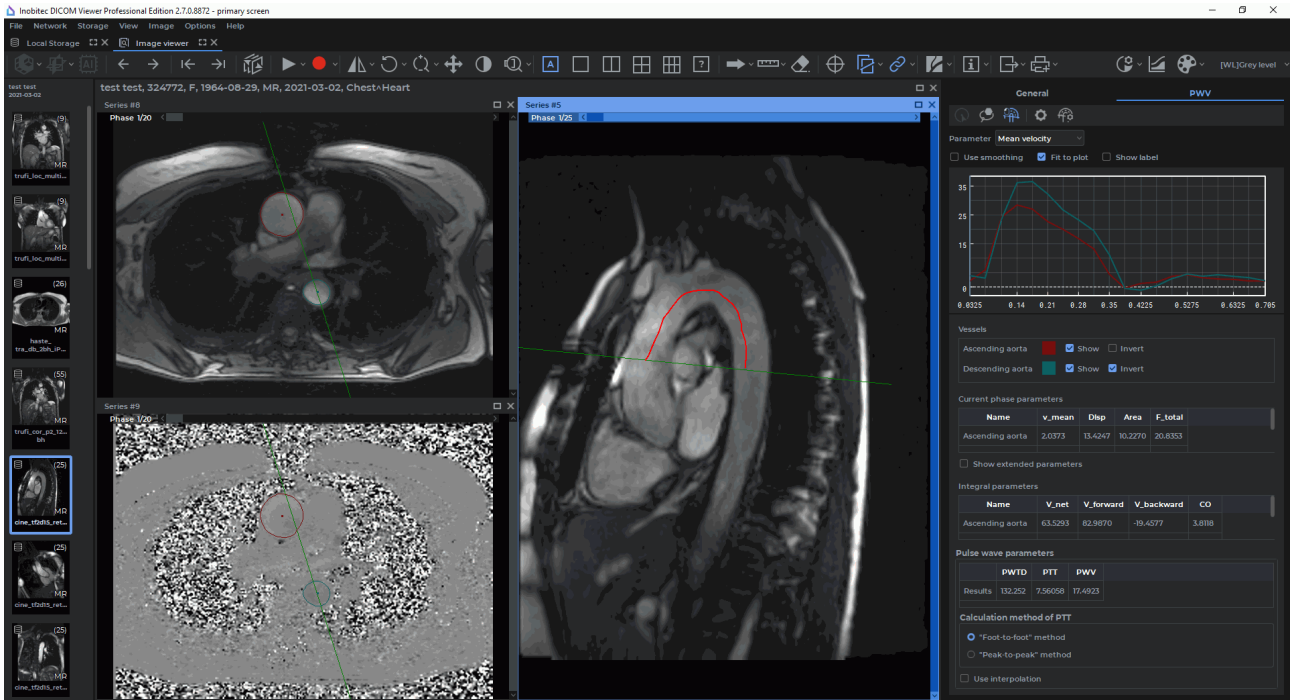



Figure 2.54: Designing a Pulse Wave Trajectory

- To edit a trajectory, mouse over the line to be edited. The trajectory line will be highlighted. Press the mouse button at the point where you want to edit the trajectory and draw a new line towards one of the ends of the trajectory while holding the button. Release the mouse button to finish the editing process. All the parameters for advanced blood flow analysis will be reevaluated. Press **Esc** on your keyboard while still holding the mouse button to cancel the trajectory building or editing operations.

You can change the Pulse Wave Travel Distance (PWTD) value in three ways:

- by editing the trajectory of the pulse wave;
- by clicking on the  **PWV settings** button and enter a new value in the dialog box. Previously constructed pulse wave trajectory is removed;
- by manually changing the value in the **PWTD** column of table **Pulse wave parameters**. Previously constructed pulse wave trajectory is removed.

If after returning to the **General** tab, you delete one of the vessels considered in the process of advanced blood flow analysis, the pulse wave trajectory and the pulse wave parameters (PWTD, PTT, and PWV) will be deleted.

If you close the sagittal plane window, the pulse wave trajectory designed will be deleted, but the PWTD, PTT, and PWV parameters will be saved.

## 2.21.7 Getting the Results of Advanced Blood Flow Analysis without Building a Pulse Wave Trajectory

Functionality is available in the **Pro** edition



**This function cannot be used for establishing a diagnosis**

If there is no sagittal plane series in the study, but the pulse wave travel distance is known, you may enter this value manually to display the results of advanced blood flow analysis.

To get the results of advanced blood flow analysis without building a pulse wave trajectory, proceed as follows:

1. Open the **MAG MRI** and **PC MRI** series in the blood flow parameters evaluation mode (for details see Section 2.21.1).
2. Go to the **PWV** tab. When you first click on the «**PWV**» tab the **PWV settings** dialog box is displayed (Fig. 2.55).



**Any two sections of the same vessel placed on the same slice or on different slices may be selected as the input and output vessels. The vessel characterized by a smaller time to peak value of the blood flow graph is selected as the input vessel. If the time to peak values are the same for both vessels, the one placed higher on the Vessels table is selected as the input vessel. The PWV tab will be available after such a pair of vessels has been found.**

3. In the **PWV settings** dialog box (Fig. 2.55), enter the pulse wave travel distance value (in millimeters).

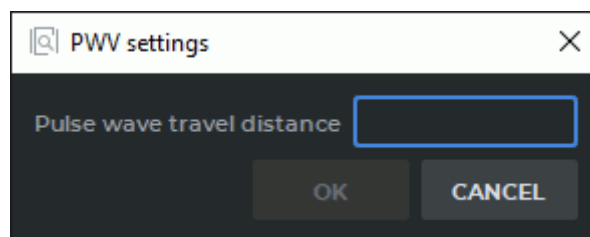

Figure 2.55: The dialog box for providing the pulse wave travel distance value

To get the results of advanced blood flow analysis, click the **OK** button. To go back to the **General** tab, click the **CANCEL** button.

you have not provided the pulse wave travel distance value in the dialog box (Fig. 2.55), the **OK** button will be inactive.

You can change the Pulse Wave Travel Distance (PWTd) value in two ways:

- by clicking on the  **PWV settings** button and enter a new value in the dialog box;

- by manually changing the value in the **PWTD** column of table **Pulse wave parameters**.

## 2.21.8 Blood Flow Analysis Panel. Displaying the Results of Advanced Blood Flow Analysis

Functionality is available in the **Pro** edition



**This function cannot be used for establishing a diagnosis**

The results of advanced blood flow analysis are displayed as graphs and tables.

Chart display settings are configured similarly to the settings of charts on the **General** tab (see Section 2.21.4).

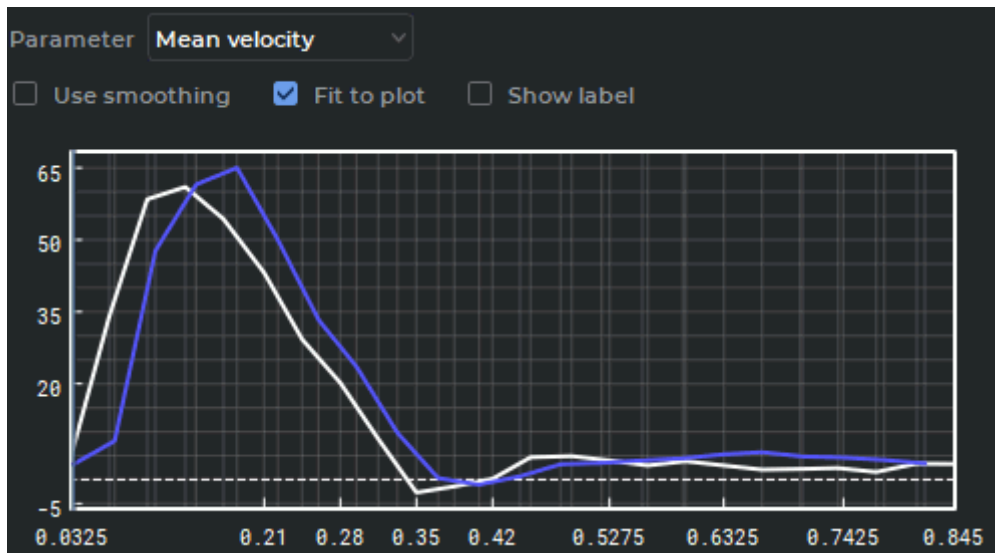

Figure 2.56: The graphs showing the blood flow parameters for the selected pair of vessels

The **Vessels** table (Fig. 2.57) is used to customize the display settings for the vessels' ROI and graphs.

Vessels					
Input vessel	Slice #2		<input checked="" type="checkbox"/> Show	<input type="checkbox"/> Invert	
Output vessel	Slice #1		<input checked="" type="checkbox"/> Show	<input checked="" type="checkbox"/> Invert	

Figure 2.57: The **Vessels** table

The ROI display and vessels graph settings are described in the Section 2.21.4.

In the **Current phase parameters** table are displayed the blood flow parameters. Similar to the table on the **General** tab (see Section 2.21.4).

In the **Integral parameters** table integral blood flow parameters are displayed. Similar to the table on the **General** tab (see Section 2.21.4).

In the **Pulse wave parameters** table (Fig. 2.58) you will see the results of the evaluation of the following parameters:

- **Pulse wave travel distance (PWTD)**. There are three ways to specify this parameter:
  - manually, in the **PWV settings** dialog box (see Section 2.21.7);
  - manually, in the **PWTD** column of the **Pulse wave parameters** table;
  - by way of building a pulse wave trajectory (see Section 2.21.6).
- **Pulse transit time (PTT)**;
- **Pulse wave velocity (PWV)**.

The screenshot shows a software interface for pulse wave parameters. At the top, there is a table with the following data:

	PWTD	PTT	PWV
Results	0.1493	0.0330	4.5220

Below the table is a section titled "Calculation method of PTT" with two radio button options: "Foot-to-foot" method (selected) and "Peak-to-peak" method. At the bottom of this section is a checkbox labeled "Use interpolation" which is currently unchecked.

Figure 2.58: The **Pulse wave parameters** table

If the **PWTD** parameter has not been specified, in the respective cell of the table, you will see a *No data* sign instead of the assessment result. The **PTT** and **PWV** parameters will be calculated automatically. If an error occurs during the calculation procedure, you will see a *No data* sign in the cell for the respective parameter.

In the section named **Calculation method of PTT**, you choose the method of calculating the pulse transit time:

- **Foot-to-foot** (the default value);
- **Peak-to-peak**.

The **Use interpolation** check box enables cubic spline interpolation of the data for **PTT** calculation. When you check/uncheck this box, the **PPT** and **PWV** parameters will be reevaluated.

### 2.21.9 Evaluation of the Parameters for Advanced Blood Flow Analysis

Functionality is available in the **Pro** edition



**This function cannot be used for establishing a diagnosis**

In advanced blood flow analysis for the vessel slices pair, the PWV parameter is calculated based on two auxiliary parameters.

Advanced blood flow analysis implies the calculation of additional parameters, such as:

- **Pulse wave travel distance** (*PWTD*, measured in mm). This parameter is calculated as the distance between a pair of vessel slices. The trajectory between the sections may be built with the **Pulse wave travel path** tool;
- **Pulse transit time** (*PTT*, measured in ms). This parameter is calculated on the basis of the blood flow graphs of vessel slices by two methods:
  - **Foot-to-foot**. The value is calculated according to the formula below:

$$PTT = TTF_{OV} - TTF_{IV} \quad (2.10)$$

where  $TTF_{OV}$  is the time to the foot of the output vessel graph,  
 $TTF_{IV}$  is the time to the foot of the input vessel graph;

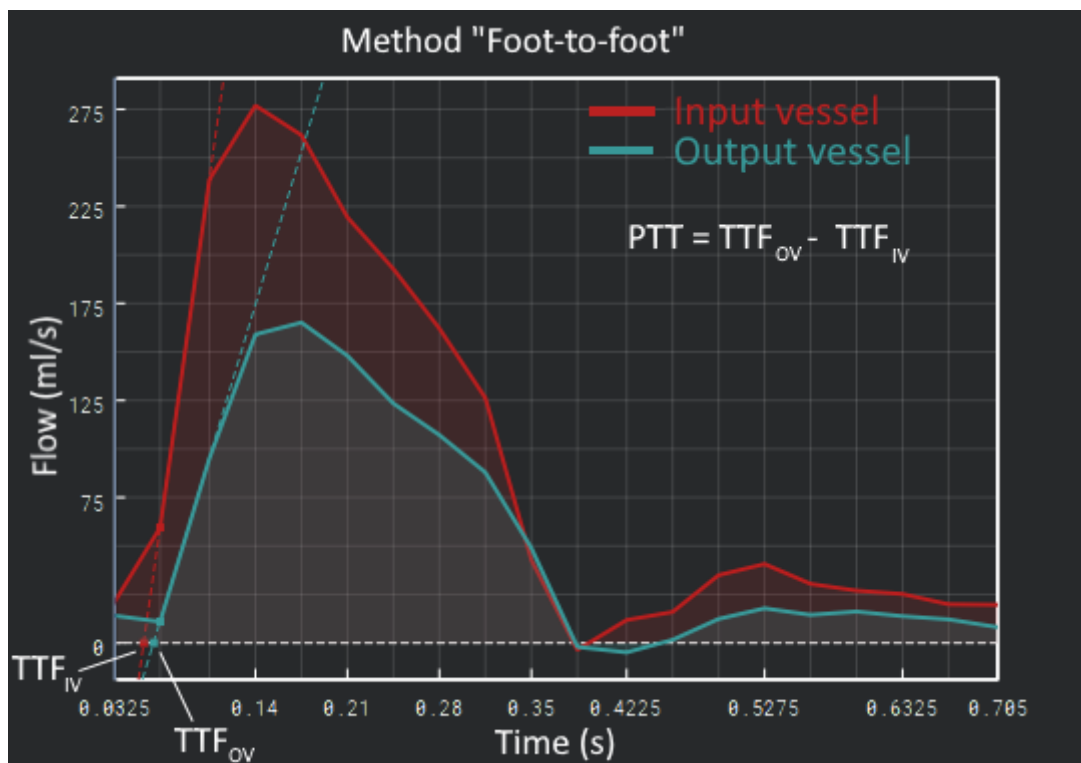

Figure 2.59: Graphical interpretation of the **Foot-to-foot** method

- **Peak-to-peak.** The value is calculated according to the formula below:

$$PTT = TTP_{OV} - TTP_{IV} \tag{2.11}$$

where  $TTP_{OV}$  is the time to the peak of the output vessel graph,  $TTP_{IV}$  is the time to the peak of the input vessel graph;

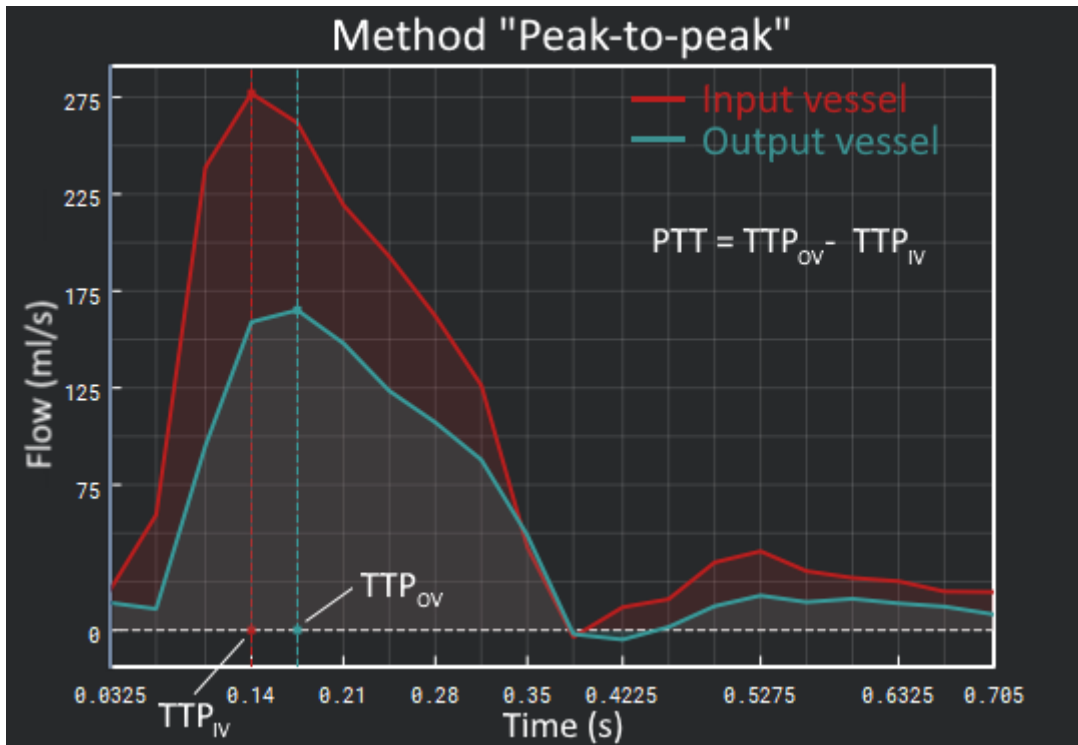

Figure 2.60: Graphical interpretation of the **Peak-to-peak** method

- **Pulse wave velocity (PWV)** ( $PWV$ , measured in m/s). The value is calculated according to the formula below:

$$PWV = PWTD/PTT \tag{2.12}$$

### 2.21.10 Blood Flow Parameters Evaluation for Two Slices

Functionality is available in the **Pro** edition



**This function cannot be used for establishing a diagnosis**

Each pair of series (**MAG MRI** and **PC MRI**) that can be used for blood flow analysis represents a separate slice. Besides the **PWV** parameter evaluation, work with two or more slices



provides an opportunity to compare common blood flow parameters for sections of the vessels placed on different slices.

To perform blood flow parameters evaluation for two slices, proceed as follows:

1. Open several pairs of series (MAG MRI and PC MRI) suitable for blood flow analysis. Each pair of series represents a separate slice. Provide the missing parameters if required (see Section 2.21.1).

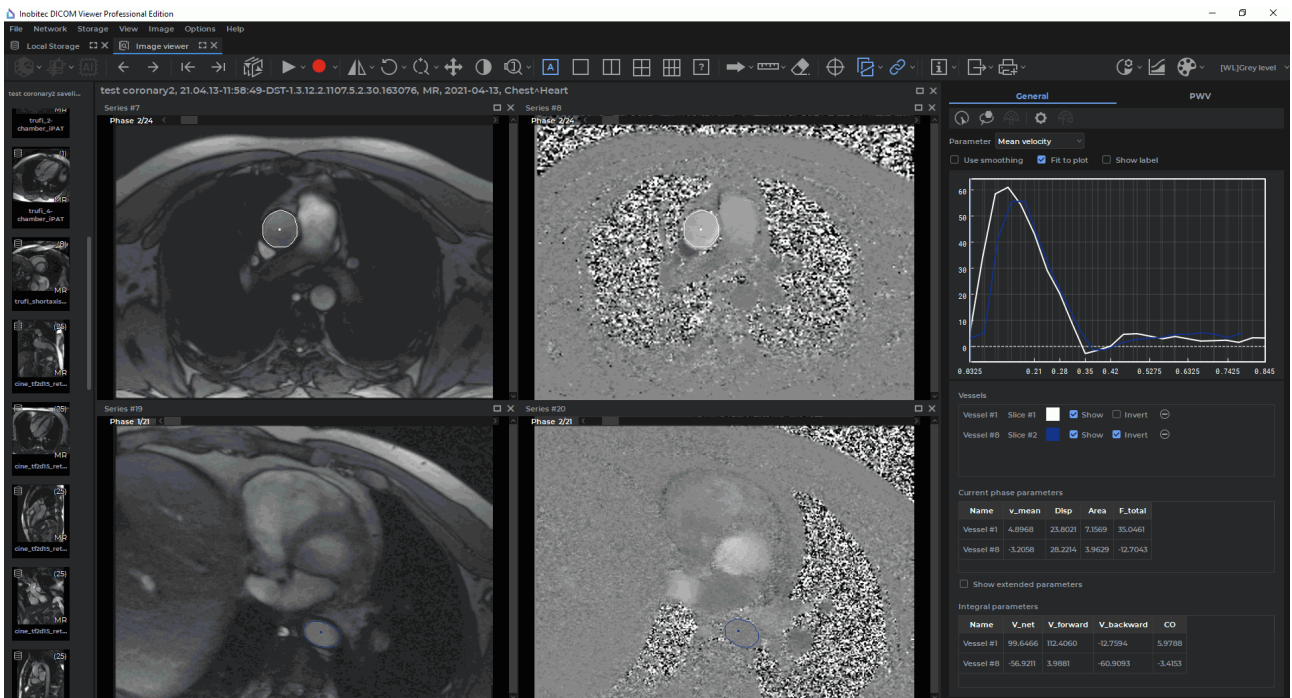

Figure 2.61: The mode for blood flow parameters evaluation on the basis of two slices

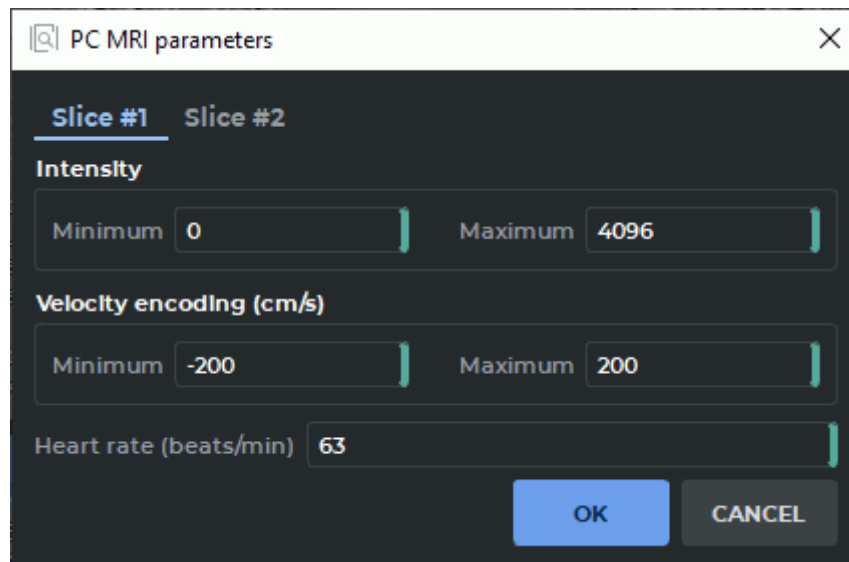

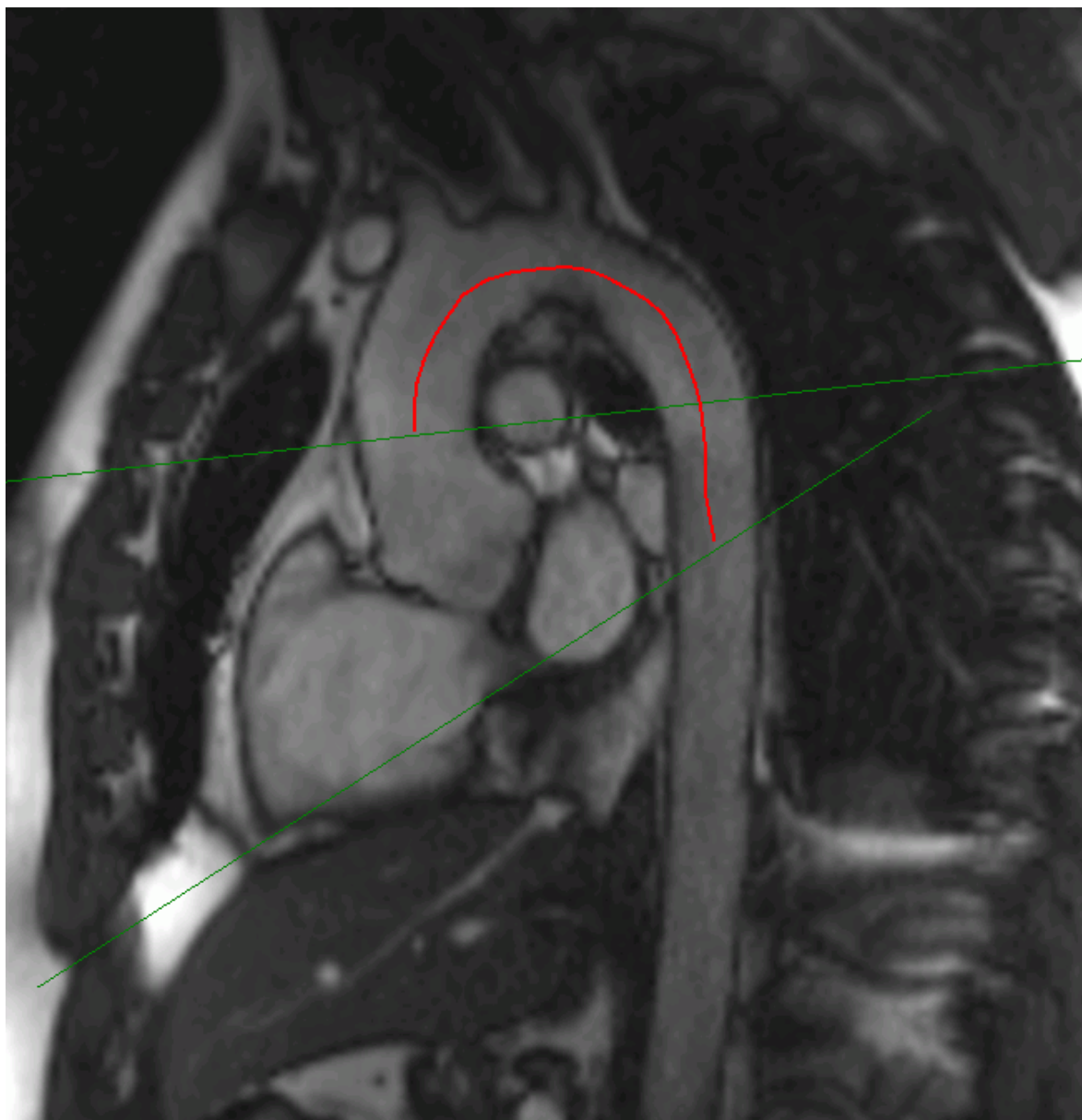

Figure 2.62: The dialog box for changing PC MRI parameters for each slice

2. To change the configuration parameters for a PC MRI series, click the  **PC MRI parameters** button on the blood flow analysis panel. In the **PC MRI parameters** dialog box (Fig. 2.62) change the current parameter values for each slice. For more information see Section 2.21.2.
3. Build or edit the vessel ROI for each slice (see Section 2.21.3).

On the **General** tab, general blood flow results are analyzed for each vessel detected. The results of general blood flow analysis are presented as graphs and tables. For more information see Sections 2.21.4 and 2.21.5).

4. To evaluate the **PWV** parameter, build a trajectory for the pulse wave between the selected vessel sections Fig. 2.63, (see Section 2.21.6). If there is no sagittal plane series in the study but the pulse wave travel distance is known, enter the value manually (see Section 2.21.7).



*Figure 2.63: Trajectory for the pulse wave between the slices*

In the **PWV** tab (Fig. 2.64) of the blood flow analysis panel, the results of advanced blood flow analysis are shown as graphs and tables (see Sections 2.21.8 and 2.21.9).

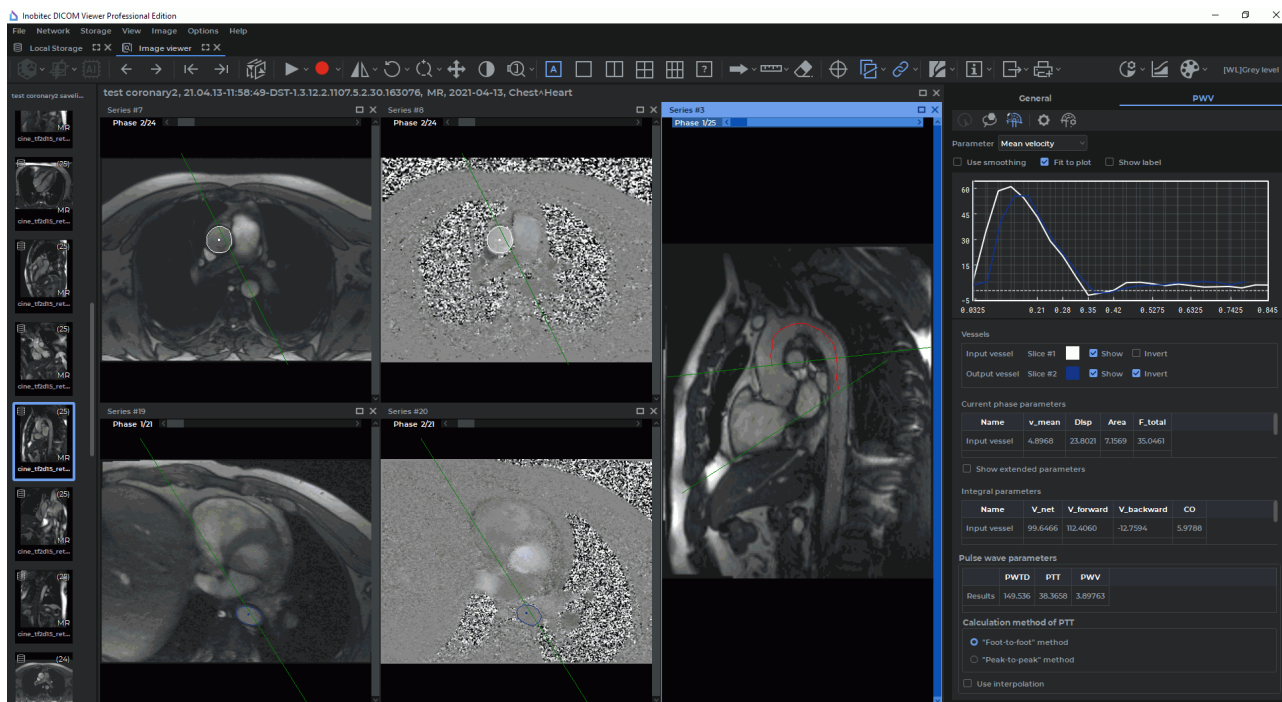

Figure 2.64: The results of advanced blood flow analysis for two slices

## 2.22 Visualize Images

### 2.22.1 Select CLUT

Select the CLUT (colour look-up table) from the drop-down menu on the rendering setup panel (Fig. 2.65).



Figure 2.65: Rendering setup panel

You can choose from the following groups of CLUTs:

- relative **[WL]**;
- absolute **CT** and **XA**;
- special, **Palette color**. This type of CLUT is used for adequate display of the images belonging to series where there is at least one image with the *Photometric Interpretation (0028,0004)* tag value equal to PALETTE COLOR.

If, when a series is opened, the first image displayed has the *Photometric Interpretation (0028,0004)* tag value equal to PALETTE COLOR, the **Palette color** CLUT will be automatically selected. If the first image displayed has a different *Photometric*

*Interpretation (0028,0004)* tag value, the relative [WL] CLUT will be selected for the group. In this case, you will have to select the **Palette color** CLUT manually to view the images with the PALETTE COLOR value of the *Photometric Interpretation (0028,0004)* tag.

When the **Palette color** CLUT is used, the **Custom W/L**  button is unavailable.

## 2.22.2 Edit CLUTs List

To edit the list, open the CLUTs setup tab by clicking the **CLUTs**  button. The tab is shown in Fig. 2.66.

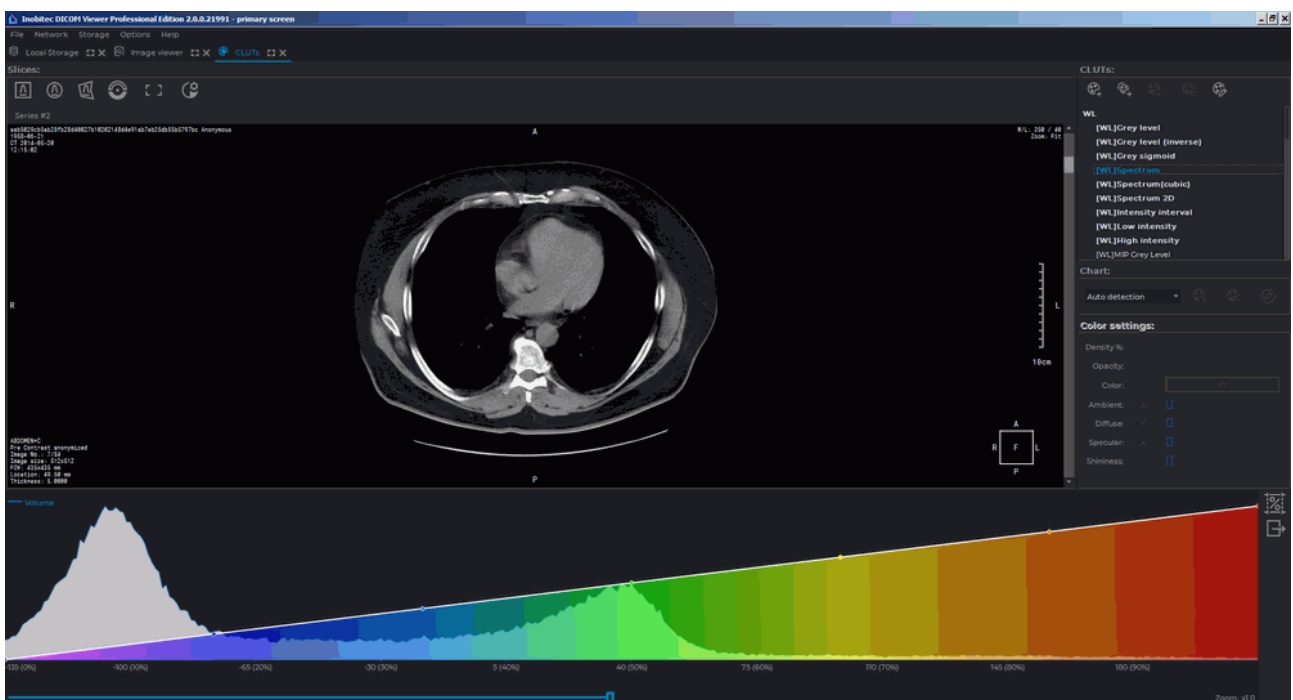

Figure 2.66: CLUTs setup tab

CLUTs setup panel is located on the right-hand side of the window (Fig. 2.67).

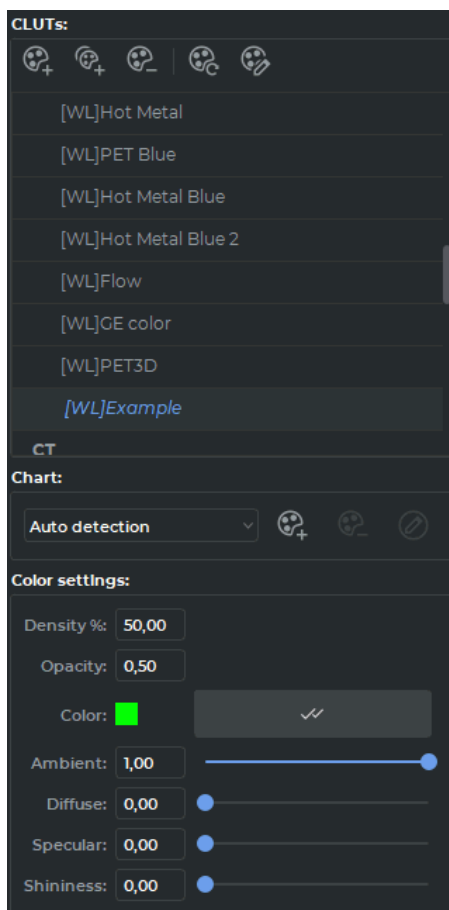

Figure 2.67: CLUTs setup panel

The CLUTs list edit buttons are located at the top of the panel.

	<b>Add a new CLUT as a copy of the current one</b> adds a new CLUT as a copy of the selected one
	<b>Add a new group</b> adds a new group of CLUTs
	<b>Remove the selected CLUT/group</b> deletes the selected CLUT or group. Predefined groups and some CLUTs cannot be deleted
	<b>Reset the selected CLUT to its original state</b> sets up default parameters for the selected CLUT
	<b>Edit CLUT/group</b> opens the CLUT or group setup dialog

The groups contain several CLUTs (e.g., WL, CT, XA) and are intended for structuring the list. They are marked by the arrow (Fig. 2.68) on the drop-down menu (Fig. 2.65). For the description of the process of assigning the group type to the user CLUTs, see Section 2.22.4.



Figure 2.68: Group of CLUTs

To add a new group, set the following parameters in the dialog box (Fig. 2.69):

1. **Name:** any name of group;
2. **Required tags:** labels that must contain CLUTs to be included in the group.

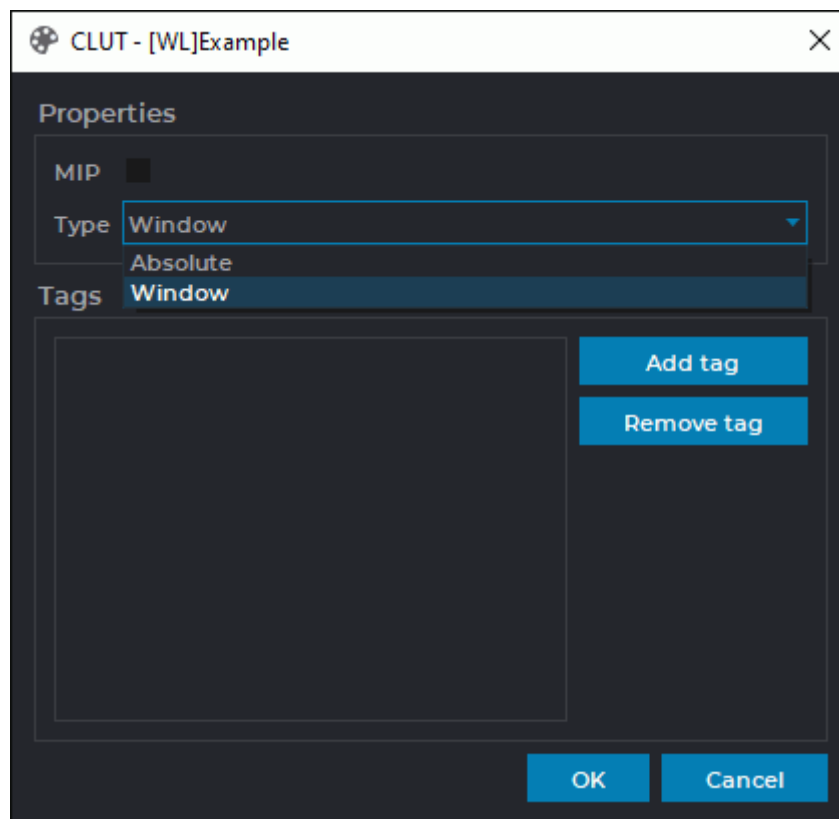



Figure 2.69: Group setup dialog box

### 2.22.3 CLUT Parameters

To browse the settings for the selected CLUT, click the **Rendering transfer function**  button. The panel displaying the visualization transfer function graph will appear at the bottom of the study window (see the example in Fig. 2.70).

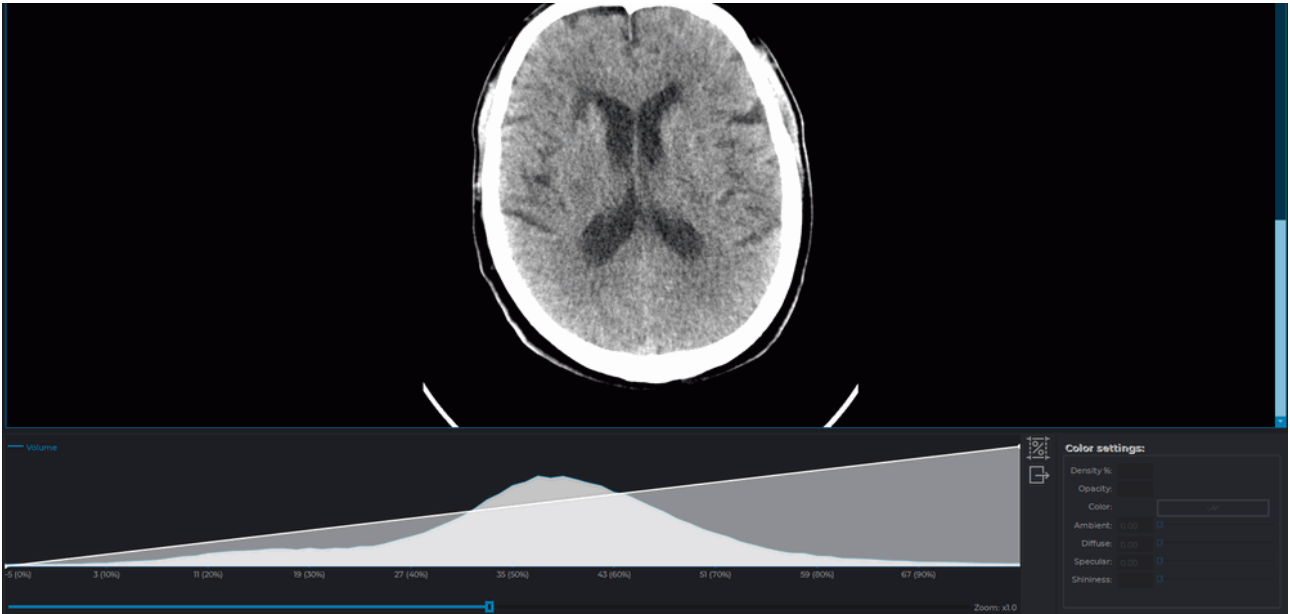

Figure 2.70: Rendering transfer function graph

You cannot change the setup parameters for predefined CLUTs.

Intensity will be displayed on the horizontal axis, while the number of points with a particular intensity will be shown on the vertical axis (blue line). The default scale may not allow you to see the intensity distribution graph (blue) at once. To change the horizontal axis scale, move the scroll under the axis or roll the mouse wheel while the cursor is located on the scrollbar. The scale value will be displayed to the right of the scrollbar. To change the vertical axis scale, roll the mouse wheel while the cursor is located on the visualization setup panel, but not on the scrollbar. Fig. 2.71 shows the same graph as in the previous figure, but with a greater intensity distribution scale (on the vertical axis).

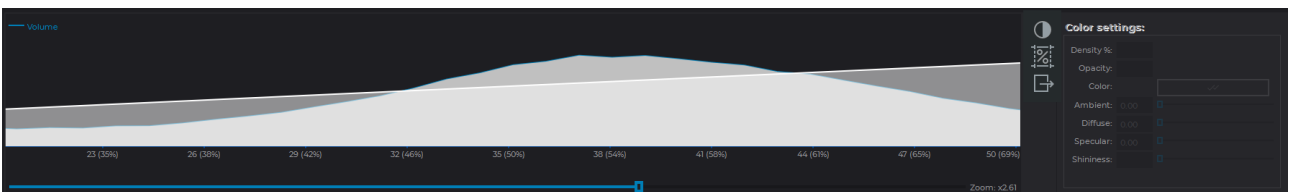

Figure 2.71: Intensity distribution graph with a greater vertical axis scale

The color/transparency chart (white line) is superimposed on the intensity distribution scale. The horizontal axis shows the intensity, and the vertical axis shows the transparency of the color highlighting the points with this intensity. The color is displayed below the graph. The horizontal axis scale changes for both graphs simultaneously, while the vertical axis scale for the color/transparency chart does not change. To move the graph along the horizontal axis, hold the left mouse button.



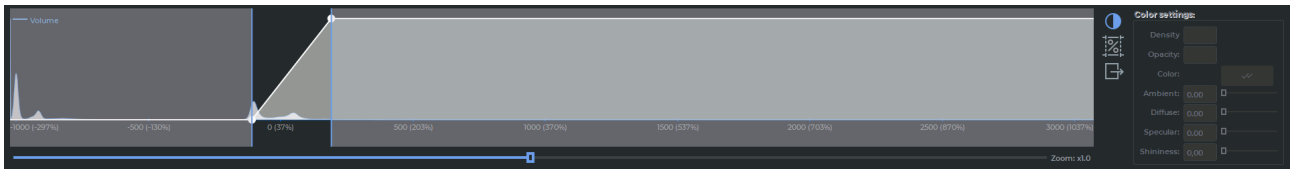







Figure 2.72: Displaying the window level and width edges

To show the current edges of the window level and width (**W/L**) in the histogram window, click the  **Adjust W/L** button on the rendering transfer function panel. This mode is switched on by default. The current edges of the window level and width are displayed as blue vertical lines in the histogram window (Fig. 2.22.3).

The DICOM Viewer provides an opportunity to adjust the edges of the window level and width in the histogram window. To do it, mouse over one of the edges so that the cursor is displayed as  $\longleftrightarrow$ . Move the edge while holding the left mouse button. On the flat image viewer tab, the edges of the window level and width are only displayed for relative CLUTs (the CLUTs with the [WL] group label). If the CLUT selected on the **Image viewer** tab is absolute (and has a CT group label), the edges of the window level and width will not be shown in the histogram. The  **Adjust W/L** button on the rendering transfer function panel will be disabled. On the **MPR reconstruction** and **Volume reconstruction** tabs, the edges of the window level and width will be shown in the histogram for all the types of CLUTs.

To find out what percentage of tissue has a density in a given range, click on the **Histogram percentage**  button, move the cursor to the beginning of the range and move the cursor to the end of the range, holding the left mouse button. The percentage of tissue that has a density within the range is indicated in red (fig. 2.73). To edit a range, move the cursor to its border and move the border with the left mouse button pressed. To move a range, move the cursor on it so that the cursor would look as follows , and move the cursor, holding the left mouse button. Multiple ranges can be built at the same time. To remove the built ranges, click the **Histogram percentage** button again.

To export data on the distribution of densities, click on the  button, in the dialog that opens, specify the file name and folder, click **Save** to finish or **Cancel** for cancel.

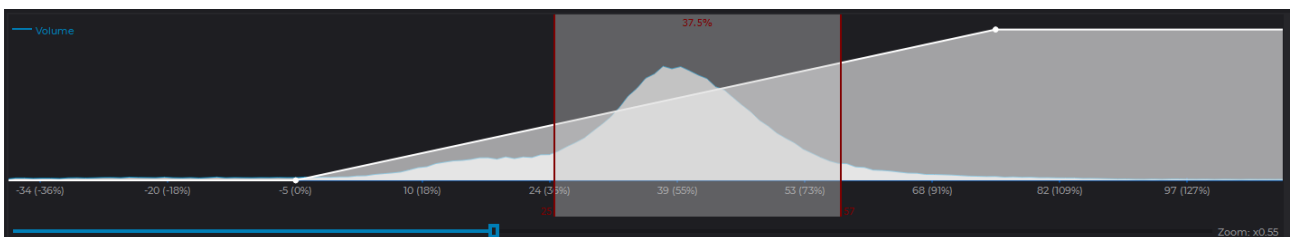









Figure 2.73: Histogram percentage

## 2.22.4 Create and Edit CLUT

To create your own CLUT:

1. Click the **CLUTs**  button to open the CLUT setup tab.
2. Copy one of the existing CLUTs by selecting it from the list and clicking on the **Add a new CLUT as a copy of the current one**  button.
3. To rename a CLUT, double-click the left mouse button on it, enter the new name and press the **Enter** key on the keyboard. In our example, in Figure 2.67, the table is renamed «[WL]Example».
4. Specify the required parameters:
  - **Color.** Select a point on the color/transparency chart. The color settings for this point will become available. To set the color of the current point for all the points of the chart, click the **Apply to all chart points**  button.
  - **Density.** Sets the position of the point on the horizontal axis. The alternative way to set this parameter is to move the point along the horizontal axis using the mouse.
  - **Opacity.** Sets the opacity of the color. 1 — maximum, 0 — minimum. The alternative way to set this parameter is to move the point along the vertical axis using the mouse.
5. To add a point, locate the cursor on the graph so that it looks like , right-click the mouse and select the **Add point** item.
6. To delete a point, locate the cursor on the point so that it looks like , right-click the mouse and select the **Remove point** item.
7. To restore the original settings for this CLUT, click the **Reset the selected CLUT to its original state**  button.
8. To assign a group type to the CLUT, click the **Edit CLUT/group**  button at the top of the CLUTs settings panel. In the **CLUT** dialog box (Fig. 2.74), select the group type to which the table belongs from the drop-down list:
  - **Window**, if the CLUT is relative and has a group label [WL];
  - **Absolute**, if the CLUT is absolute and has a group label CT and XA.

Click **OK** to apply the settings or **CANCEL** to cancel.

9. To add the tags that the CLUT should contain, click the **Edit CLUT/group**  button at the top of the CLUTs panel. In the **CLUT** dialog box (Fig. 2.74), click the **ADD TAG** button and enter the tag name in the input area. To rename a tag, double-click on the tag name, enter the new name and press the **Enter** key on your keyboard. To remove a tag, select it and click the **REMOVE TAG** button.

Click **OK** to apply the settings or **CANCEL** to cancel.

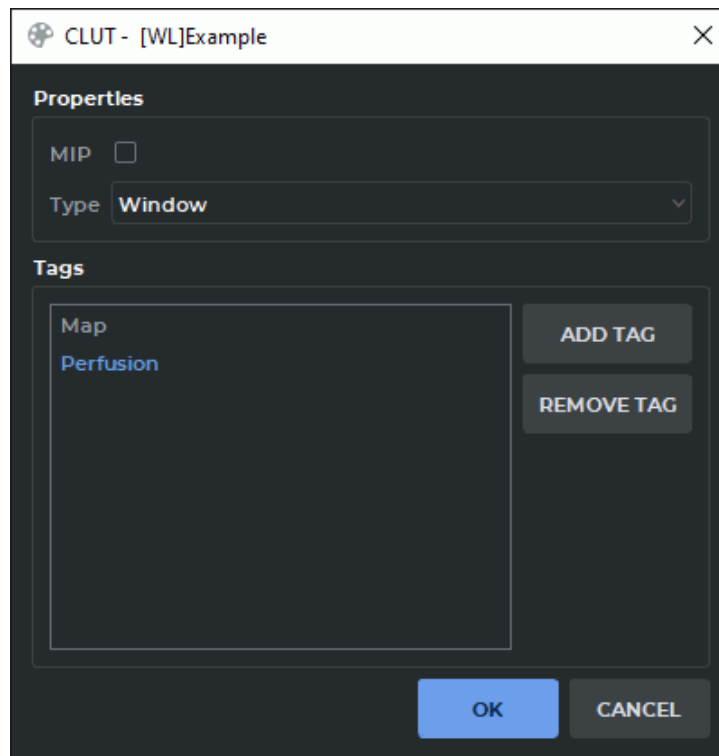





Figure 2.74: CLUT dialog box

To delete a CLUT, click the **Remove the selected CLUT/group**  button.

The DICOM Viewer allows you to add additional color/transparency charts. To add:

1. Click the **Add chart**  button. A new chart will appear at the bottom part of the window, and its name will be added to the drop-down chart menu. The opened menu is shown in Fig. 2.75.
2. To rename the selected chart, click the **Edit chart name**  button, type new name and press **Enter** key on the keyboard.
3. To delete the selected chart, click the **Remove chart**  button.
4. To move all the charts along the horizontal axis, locate the cursor so that it would not to be on any chart and move it, holding the left mouse button.
5. To move any chart, select **Auto detection** from the drop-down chart menu, locate the cursor on the some chart and move it, holding the left mouse button.
6. To move a certain chart, select its name from the drop-down chart menu, locate the cursor on this chart and move it holding the left mouse button. This mode is useful if the charts overlap.

If the charts overlap, the colors are mixed.

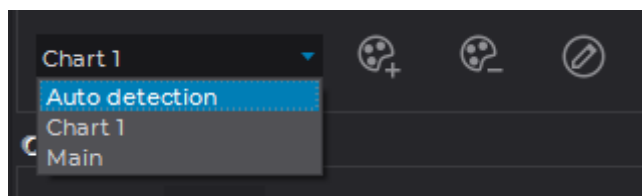

Figure 2.75: Drop-down chart menu

### 2.22.5 User CLUTs Import

User CLUTs may be imported from one of the program versions to another. This function provides an opportunity to use the CLUTs created by another user or in another DICOM Viewer version. For details, see the Section 16.9.3.

## 2.23 SUV Measurement

Functionality is available in the **Pro** edition

SUV (Standardized Uptake Value) is a value reflecting the intensity of contrast accumulation in tissues. To measure the SUV:

1. Open a series suitable for SUV measuring.
2. Select the **Image** main menu, select the **SUV** item and the **Show SUV** command. If the selected series is not suitable for SUV measuring, then the **Show SUV** command is disabled. If SUV measuring is already activated, then the **Show SUV** command is marked with a flag.
3. If necessary, change the CLUT to **[WL]PET** by selecting it from the drop-down list or by pressing the **Shift+F8** key combination on the keyboard. For details, see Section 2.22.1.
4. If the data contained in the study is insufficient, then the dialog shown in Fig. 2.76 appears. Specify the following data:
  - **SUV Type**. Choose one of four ways to measure SUV:
    - by body weight: **SUV Body Weight (SUVbw)**;

$$SUVbw(g/ml) = pixel(Bq/ml) * \frac{weight(g)}{dose(Bq)} \quad (2.13)$$

- by body surface area: **SUV Body Surface Area (SUVbsa)**;

$$SUVbsa (cm^2/ml) = \frac{pixel (Bq/ml) weight(kg)^{0.425} * 10000(cm^2/m^2)}{dose (Bq)} \quad (2.14)$$

- by the body mass index according to the James method: **SUV Lean Body Mass (SUVl<sub>bm</sub> James)**; For men:

$$SUVl_{bm}\left(\frac{g}{ml}\right) = \frac{pixel\left(\frac{Bq}{ml}\right)(1.1 * weight(kg) - 120.0(weight(kg) * height(cm))^2)}{decayedDose} \quad (2.15)$$

For woman:

$$SUVl_{bm}\left(\frac{g}{ml}\right) = \frac{pixel\left(\frac{Bq}{ml}\right)(1.07 * weight(kg) - 148.0(weight(kg) * height(cm))^2)}{decayedDose} \quad (2.16)$$

- by the body mass index according to the Janmahasatian method: **SUV Lean Body Mass (SUVl<sub>bm</sub> Janmahasatian)**;

$$SUVl_{bm}\left(\frac{g}{ml}\right) = \frac{pixel\left(\frac{kBq}{ml}\right)}{dose(MBq) * l_{bm}(Kg)} \quad (2.17)$$

$$bmi(Kg/m^2) = \frac{weight(kg)}{height(m)^2} \quad (2.18)$$

For men:

$$l_{bm}(Kg) = \frac{9270 * weight(kg)}{6680 + 216 * bmi(Kg/m^2)} \quad (2.19)$$

For woman:

$$l_{bm}(Kg) = \frac{9270 * weight(kg)}{8780 + 244 * bmi(Kg/m^2)} \quad (2.20)$$

- **Patient weight (Kg)** (optional for the method of calculating by body surface area);
- **Patient height (cm)**;
- **Injected dose (MBq)**;
- **Injection date time**;
- **Acquisition date time**;
- **Half-life (min)**;
- **Sex** (optional for the method of calculating by body weight and by body surface area);
- if it is necessary to display the SUV measurement results for ROI tools then check the **Use SUV for ROI tools** box.

To measure the SUV, click **OK**, to cancel the operation, click **CANCEL**. If there is not enough data to calculate (for example, the patient's weight or height is not specified or is zero), then the **OK** button is disabled.

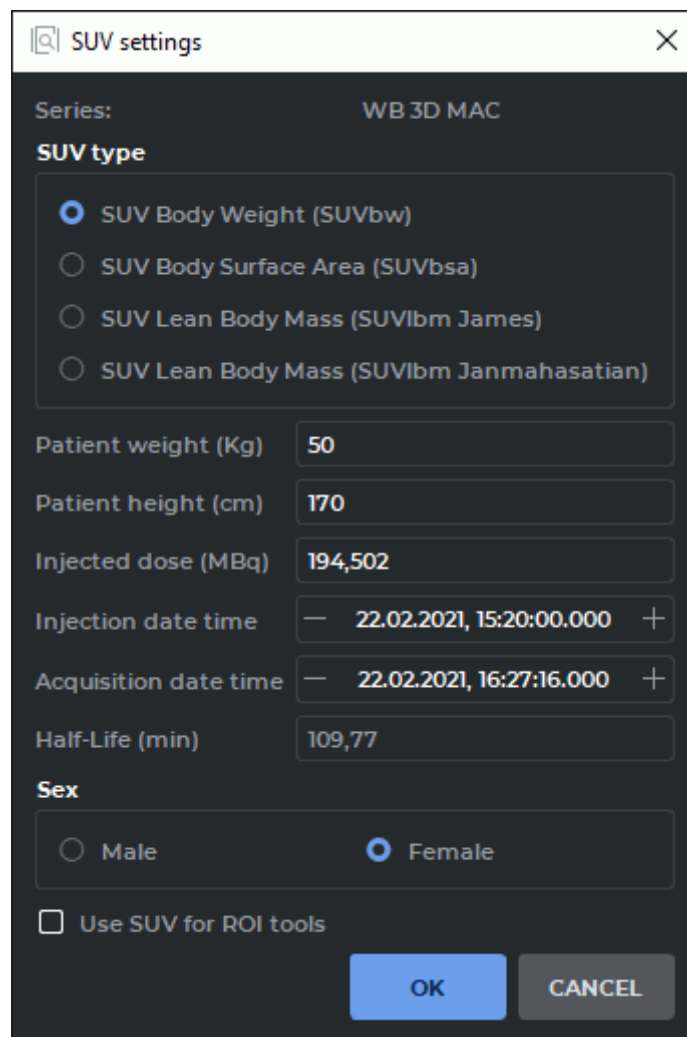



Figure 2.76: SUV Settings

5. To change the SUV calculation settings, select the **Image** main menu, select the **SUV** item and the **Settings...** item.
6. When the SUV measurement is activated, the value at the point where the cursor is located appears in the top left-hand corner of the window. For example: **SUVlbm: -0.092 g/ml**. Move the cursor over the image to measure the SUV. Please note that the **Display information**  button must be pressed (see Section 2.26).
7. To calculate the SUV in a particular area or point, use the ROI tools (see Section 2.19.6). Please note that the **Use SUV for ROI** box must be checked in the SUV settings.

If the time and the date of the series creation is greater than the time and the date of the study, then the message **Warning: This series may be post-processed in which date of series creation unrelated to acquisition** appears in the SUV Settings dialog.

To disable the SUV measurement, select the **SUV** on the main menu **Image** and select the **Show SUV** command. The density information will be displayed for the built ROIs.



## 2.24 Calcium Scoring

Functionality is available in the **Pro** edition

The DICOM Viewer allows you to measure calcium in the coronary arteries using the **Calcium scoring** tool. The conditions on which the tool is available are listed below:

- the series modality is **CT**;
- the series contains information on the slices thickness;
- slices must be shown in the axial projection (see Section 2.13).

If a series does not meet these requirements, the **Calcium scoring** tool will not be available. The tool selection button will look different depending on the tool that was used last:



	<b>Calcium scoring (ellipse)</b> (selected by default)
	<b>Calcium scoring (polygon)</b>

To switch between these tools click the arrow on the right side of the tool selection button and select the desired tool.

### 2.24.1 Selection of measurement areas

Functionality is available in the **Pro** edition

To measure calcium:

1. Open a CT series suitable for activation of the calcium measurement tool (see Section 2.24). Change the series view projection to axial if necessary (see Section 2.13).
2. Select the image to measure.
3. Activate the  **Calcium scoring (ellipse)** tool or  **Calcium scoring (polygon)**. These tools are similar to **ROI ellipse** and **ROI polygon** (see Section 2.19.6). If the study does not contain information about the age and/or gender of the patient, the dialog shown in Fig. 2.77 appears. Enter missing information and click **OK** to continue or **CANCEL** to cancel the measurement. After clicking **OK**, this dialog no longer appears until the Flat image viewer window is closed. To change the gender and/or age of the patient, close the Flat Images View window and return to step 1.

4. When the calcium scoring tool is active, a window shown in Fig. 2.78 is displayed on the screen. Move the window if necessary. To do this, move the cursor over the window title (highlighted in red in the figure) and move it, holding the left mouse button. In the upper part of the window there are vessel selection buttons:

- **LM** — Left main coronary artery
- **LAD** — Left anterior descending coronary artery
- **LCX** — Left circumflex coronary artery
- **RCA** — Right coronary artery

Select the artery for measurement by clicking the corresponding button. The choice of an artery does not affect the measurement result.

5. Build an ellipse or a polygon around the affected area. For details on how to build one, see Section 2.19.6 (the **ROI ellipse** and **ROI polygon** tools). A block with the following data is displayed near the measurement:

- The name of the artery (corresponds to the button pressed while building);
- Area of calcified lesion. If the measurement area contains several lesions then their total area is displayed;
- Agatston score;
- Volume score.

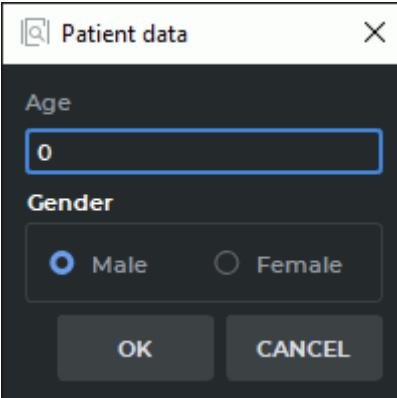

The image shows a dialog box titled "Patient data" with a close button (X) in the top right corner. The dialog has a dark background. It contains two input fields: "Age" with a text box containing the number "0", and "Gender" with two radio buttons labeled "Male" and "Female". The "Male" radio button is selected. At the bottom of the dialog are two buttons: "OK" and "CANCEL".

Figure 2.77: Patient data entry dialog



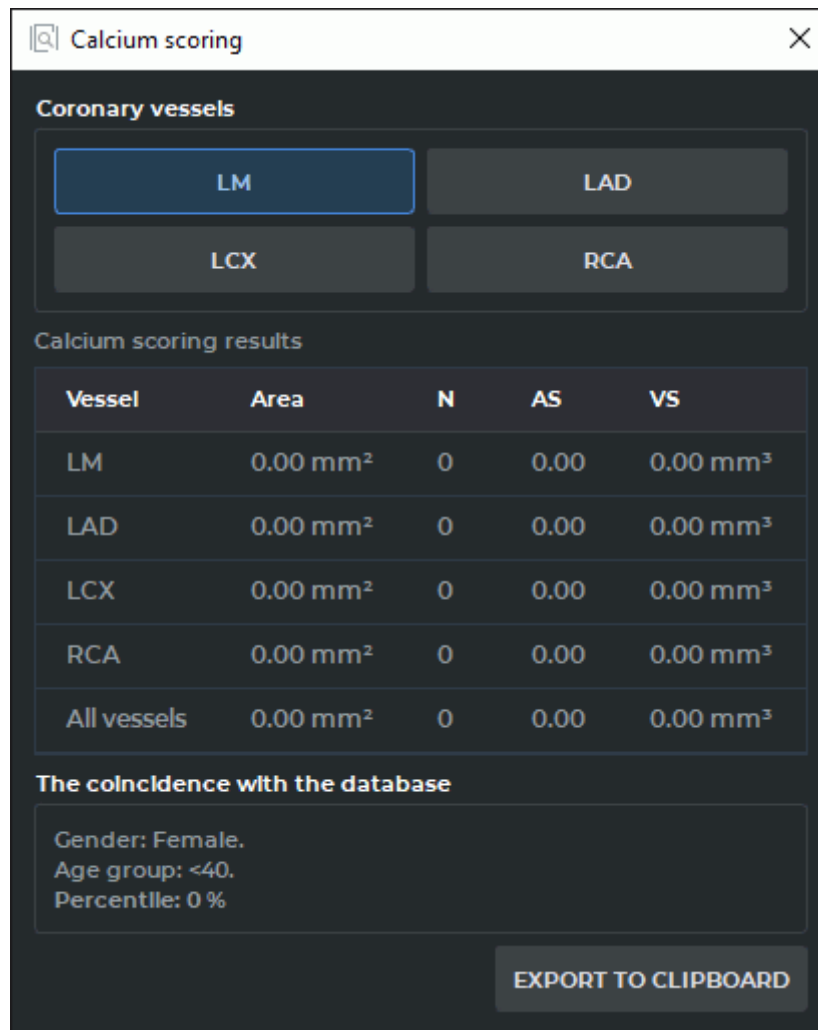



Figure 2.78: Calcium scoring



**When the projection is switched from axial to any other, the tool is deactivated.**

To deactivate the tool click the tool selection button  **Calcium scoring (ellipse)** tool or  **Calcium scoring (polygon)** or close the **Calcium scoring** window. All the changes made are saved until the Flat images view window is closed.

## 2.24.2 Actions with measurement areas

---

Functionality is available in the **Pro** edition

---

For details on how to move measurement areas, see Section 2.19.10, for how to move measurement results, see Section 2.19.11.

To edit the drawing parameters:

1. Activate the calcium scoring tool.
2. Locate the cursor on the measurement or the measurement results to highlight them.
3. Right-click the mouse and select the **Tool options...** item from the context menu.
4. In the dialog box that appears, enter the measurement name.
5. Set the color by clicking on the color box.
6. Set the line thickness and the font size.
7. To connect the block with the measurement results with a dotted line, the **Footnote line** box must be checked.
8. To display the block with the measurement results, the **Show labels** box must be checked.
9. To use these parameters by default, check the box **Set as default**.
10. To apply the settings, click **OK**. To cancel, click **CANCEL**.

### 2.24.3 Measurement results

---

Functionality is available in the **Pro** edition

---

The measurement results are displayed in the window shown in Fig. 2.78:

1. For each vessel separately and in total:
  - total lesion area (for all lesions);
  - lesion number (N);
  - Agatston score (AS);
  - Volume score (VS).
2. Patient gender
3. Age group
4. Percentile

Formula for Agatston index scoring:

$$I_{cs} = \left( \sum_{i=1}^n S_i F_i \right) \frac{T_{slice}}{3.00} \quad (2.21)$$

$I_{cs}$  — Agatston index,  $n$  — lesion number,  $S_i$  —  $i$ -lesion area,  $F_i$  —  $i$ -lesion density factor,  $T_{slice}$  — slice thickness. The  $F_i$  value is determined by the maximum pixel density in the lesion area:

Maximum pixel density	$F_i$
130–199 HU	1
200–299 HU	2
300–399 HU	3
$\geq 400$ HU	4

Formula for calcium scoring:

$$V_{cs} = \left( \sum_{i=1}^n S_i \right) T_{slice} \quad (2.22)$$

$V_{cs}$  — Agatston index,  $n$  — lesion number,  $S_i$  —  $i$ -lesion area,  $T_{slice}$  — slice thickness.

Electron beam tomographic coronary artery calcium score percentiles for men and Women within each age strata

	Age								
	<40	40-44	45-49	50-54	55-59	60-64	65-69	70-74	>74
Man (25251)	3504	4238	4940	4825	3472	2288	1209	540	235
25th percentile	0	0	0	1	4	13	32	64	166
50th percentile	1	1	3	15	48	113	180	310	473
75th percentile	3	9	36	103	215	410	566	892	1071
90th percentile	14	59	154	332	554	994	1299	1774	1982
Woman (9995)	641	1024	1634	2184	1835	1334	731	438	174
25th percentile	0	0	0	0	0	0	1	3	9
50th percentile	0	0	0	0	1	3	24	52	75
75th percentile	1	1	2	4	23	57	145	210	241
90th percentile	3	4	2	55	121	193	410	631	709

The measurement results are exported in the html format can be inserted into report editor (see Chapter 18) or in a text editors that support the html markup, for example, LibreOffice Writer or Microsoft Word. To do this click the **EXPORT TO CLIPBOARD** button, create a document in a text editor and paste the copied information into it.

## 2.25 Scout Lines

The  **Show series scout lines** tool is used if two or more series are opened for a particular study. The tool allows you to display the series image scout lines in images from other series if they are synchronized.

By default, the current image scout line is highlighted in green, and the boundary scout lines are highlighted in yellow (Fig. 2.79). If the **Show all scout lines** mode is active, the intermediate scout lines are highlighted by a dotted line, and current and boundary scout lines are highlighted by solid lines.

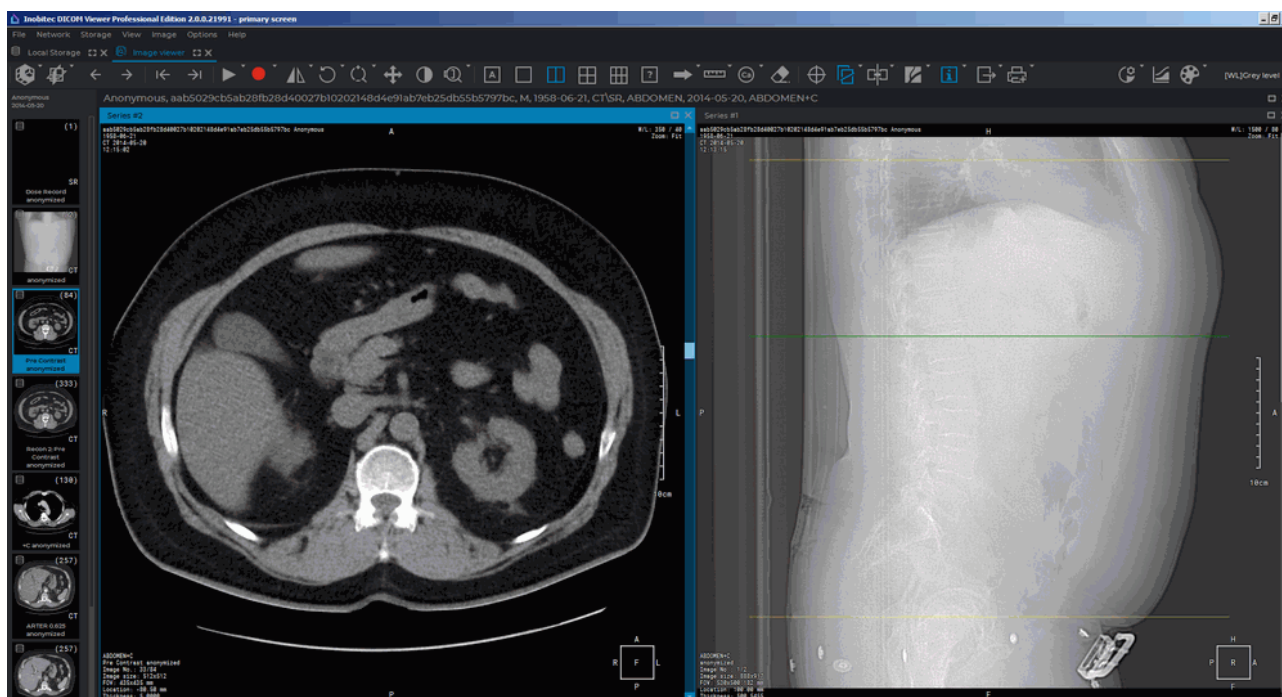



Figure 2.79: The left-hand image scout line is displayed in the right-hand image

The study series must have the same value of the FrameOfReferenceUID (0020,0052) tag. If study series have different values of FrameOfReferenceUID (0020,0052) tag, then the scout lines for these series are not displayed.

### 2.25.1 The Tool Menu

The  **Show series scout lines** tool menu (fig. 2.80) contains the following items:

1. Mode **Show all scout lines** shows the scout lines of all series images, not just of the current one.
2. The **Show bound scout lines** mode shows boundary scout lines in all the open windows. The mode is set by default.
3. Mode **Scout lines on selected view** shows in the current window scout lines of images opened in other windows.
4. Mode **Selected view scout lines** shows the scout lines of the current image in other windows.
5. **Line settings...** opens the dialog to configure the scout lines settings (Fig. 2.81).

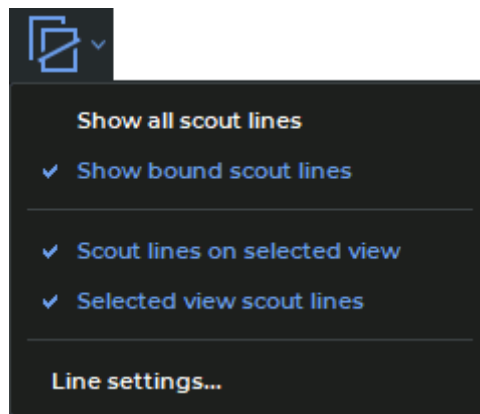



Figure 2.80: The menu for setting the scout lines display mode

To activate/deactivate the mode of this tool, click on the arrow on the right side of the  button and check/uncheck the corresponding item.

The modes are activated independently.

By default, the **Show series scout lines** tool is active and the **Selected view scout lines** mode is checked. To activate/deactivate the tool, click the  button on the toolbar.

### 2.25.2 Line Settings

To set the color and width of lines:

1. Click on the arrow on the right side of the  button and select the **Line settings...** item. A dialog box shown in Fig. 2.81 will be displayed.
2. Set the line color. To do this, click the color change button, select a color in the dialog box and click **OK**.

3. Set the line width.
4. Click **OK** to apply the changes or **CANCEL** to cancel the actions.

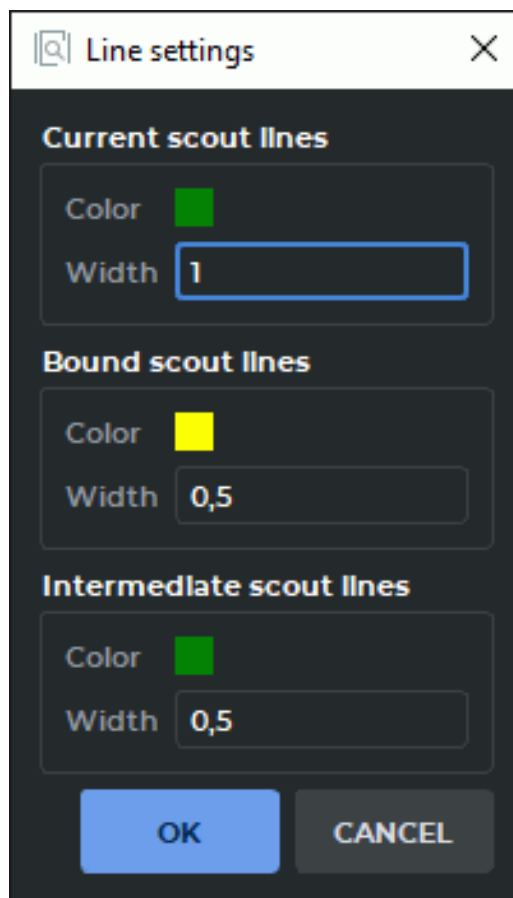



Figure 2.81: Line settings dialog box

## 2.26 Set Up Viewer Workspace

The **Show labels** tool allows you to display or hide the information about an image in the series windows. The settings are applied to all the series opened in the current tab. By default, the tool is active. To activate/deactivate the tool, click the **Show labels**  button on the toolbar.

You can adjust the visibility of:

- **Orientation cube.** Located in the lower right corner of the window (for more information see Section 2.29.1). To show (hide) the Orientation cube, click the arrow on the right side of the **Show labels** and check (uncheck) the **Show orientation cube** box. Orientation cube is active by default;
- **Point coordinates.** The point coordinates are displayed under the cursor. To show (hide) the Point coordinates, click the arrow on the right side of the **Show labels** and check (uncheck) the **Show point coordinates** box. The point coordinates are shown in the

viewer window where the cursor is placed. The coordinates are displayed as the first line in the left-hand bottom corner, in «X: px Y: px» format for original images and in «X: vx Y: vx Z: vx» format for reconstructed images;

- **Point value.** To show (hide) the Point value, click the arrow on the right side of the **Show labels** and check (uncheck) the **Show point value** box. The intensity value is displayed as the second line in the left-hand bottom corner of the viewer window where the cursor is placed. It is shown in the «Value: k HU» format for CT series and in «Value: k», where *k* is the intensity value at the point under the cursor. If the value is inaccurate, you will see a «\*» symbol next to it. This can happen when you use an **MPR reconstruction** tab or interpolation filters. For details see Sections 2.5 and 5.3;

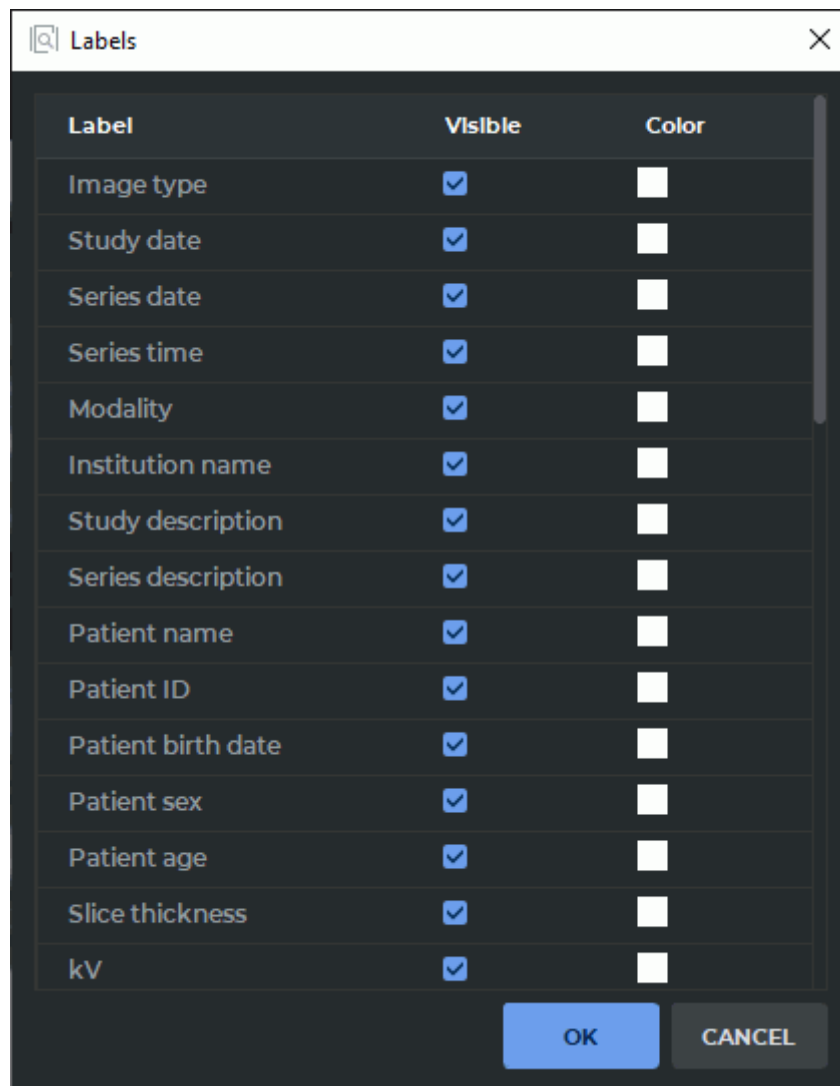

Figure 2.82: Set visible labels dialog

- **Visible labels.** To customize the list of displayed labels, click the arrow on the right side of the **Show labels** button, select the **Set visible labels...** command.

By default, all the labels are displayed in the viewer window. The color of the labels is white. In the **Labels** dialog box (Fig. 2.82), check the **Visible** boxes for the labels you

want to be displayed. In the **Color** column, you can see the color for each label. To change the color, click on the respective square and select the color required. In the tabs that were opened earlier, the color of the labels will be changed after the image is refreshed.



**The list of displayed labels depends on the series and the module in which the Labels dialog was opened.**

Click **OK** to apply the changes or **CANCEL** to cancel the actions.

To customize the labels text size, click the arrow on the right side of the **Show labels** button, select the **Set labels text size...** command and in the dialog that opens, enter an integer or fractional value. Click **OK** to apply the changes or **CANCEL** to cancel the actions.

## 2.27 Export Images

### 2.27.1 Export to DICOM

The export to DICOM allows you to export images to a series that is available while the current study is open. To export:

1. Click on the arrow on the right side of the **Quick export images**  button on the toolbar and select the **Export images...** item or press **Ctrl+E**.
2. Select the **Export to DICOM** tab. The export window will look as shown in Fig. 2.83.



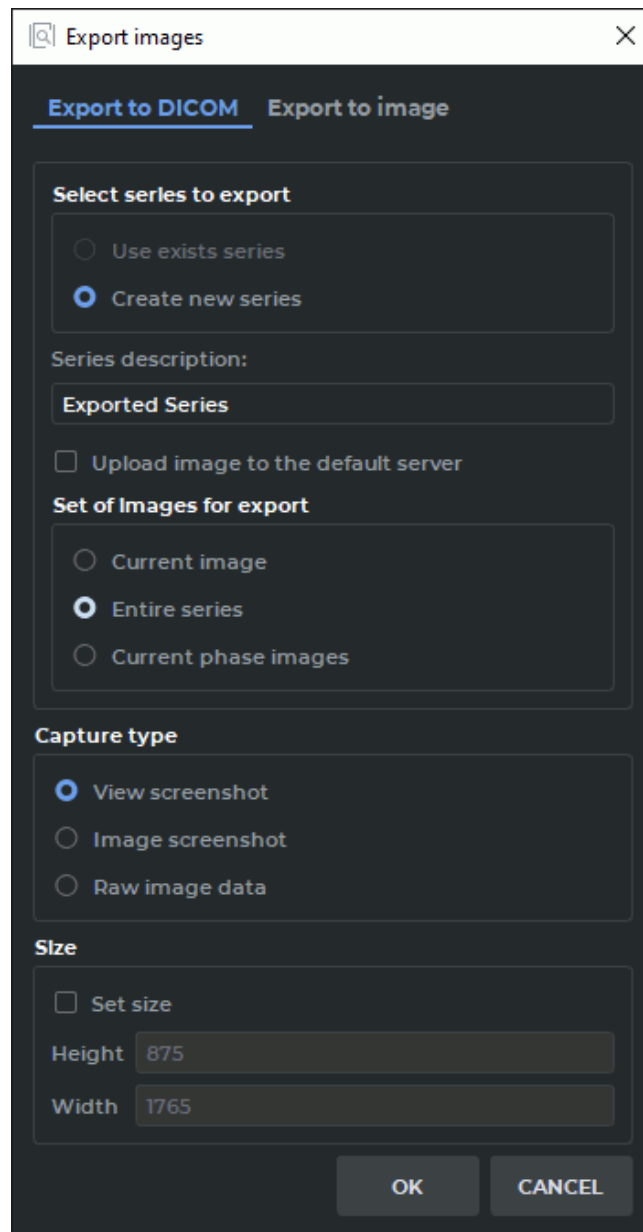



Figure 2.83: DICOM export window

3. Select the series to export. If no series has been exported yet, only the **Create new series** item will be available. If an export has been conducted before, you can export the data to the last created series by selecting the **Use exists series** option.
4. If you need to load the exported images to the DICOM server immediately, check the option **Upload image to the default server**. If the default server is not set in the DICOM Viewer this option will be inactive.
5. Select a set of images for export. Three options are available:
  - Current image;
  - Entire series;

- Current [phase](#) images (only for [multiphase](#) series).
6. Select the capture type. Three options are available:
    - **View screenshot:** the entire view window workspace is captured, including the image information without conversions performed by the user;
    - **Image screenshot:** only the image visible in the workspace (with conversions performed by the user) is captured;
    - **Raw image data:** the whole image is captured; of all the user's conversions, only mirroring is taken into account.
  7. Set the image size if necessary.
  8. To initiate export, click **OK**. To cancel the export, click **CANCEL**.

To continue exporting images to the DICOM format with the current settings, click on the **Quick export images**  button or press **F5**.

This tool is also available from the **Image** main menu item.



The results of image export to a DICOM series are affected by the filter applied (see Section [2.6](#)).



**An image to which a filter has been applied is not original, and the measurement results may be inaccurate.**

## 2.27.2 Export to Image

The export to image allows you to export the current image to a .png or .jpg file. To export data to an image:

1. Click on the arrow on the right side of the **Quick export images**  button on the toolbar and select the **Export images** button or press **Ctrl+E**.
2. Select the **Export to image** tab. The export window will look as shown in Fig. [2.84](#).
3. Set the path to the folder for export by entering it into the **Path to export** field or click the  button and select the path in the dialog box.
4. Enter the file name.
5. Select the file extension from the drop-down menu.
6. Select a set of images for export. Three options are available:
  - Current image;
  - Entire series;
  - Current [phase](#) images (only for [multiphase](#) series).
7. Select the capture type. Three options are available:
  - **capture view area:** the entire view window workspace is captured, including the image information;

- **capture visible image:** only the image visible in the workspace is captured (scale-sensitive);
  - **all image:** only the image is captured, irrespective of scale.
8. Set the image size if necessary.
  9. To initiate export, click **OK**. To cancel the export, click **CANCEL**.

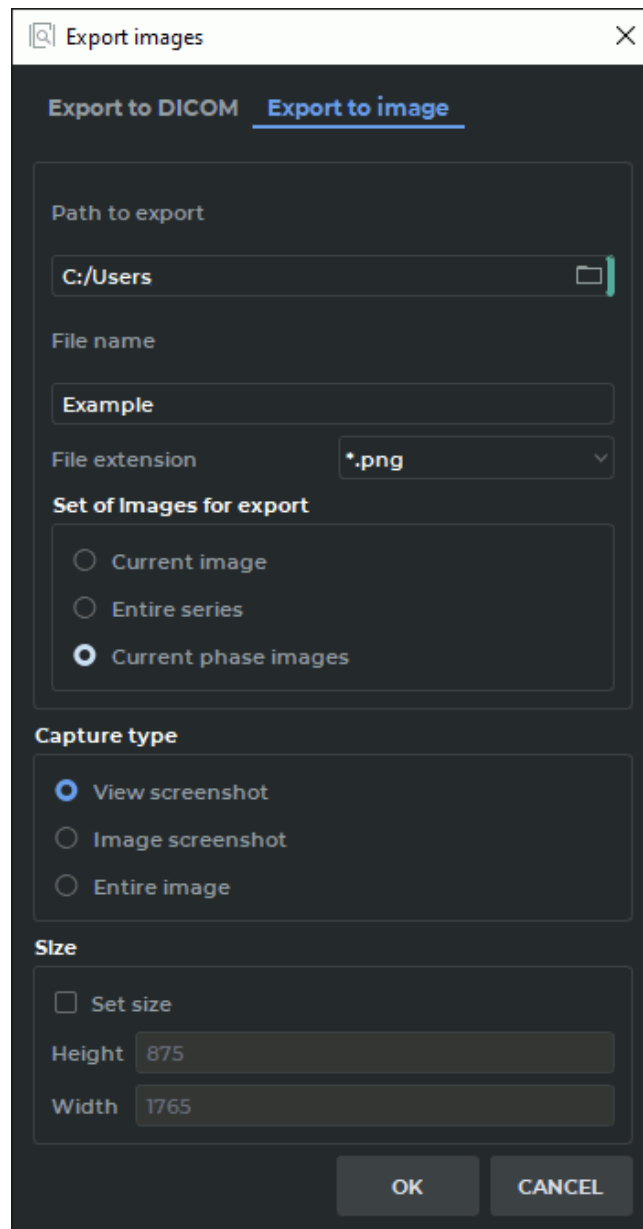



Figure 2.84: Export image to file window

To continue exporting images to a file with the current settings, click on the **Quick export images**  button or press **F5**. The file names will be specified automatically. If you attempt to export the same image twice, the DICOM Viewer will return the **«File with the same name**

**already exists. Do you want to overwrite it?»** warning. To overwrite the image, click **YES**. To cancel, click **NO**.

This tool is also available from the **Image** main menu item.

The results of image export to a file are affected by the filter applied (see Section 2.6).



**An image to which a filter has been applied is not original, and the measurement results may be inaccurate.**

## 2.28 DSA Mode

Using the DSA mode you can process multiphase and multiframe series with a varying concentration of a contrast agent, subtracting images in such a way that the tissues containing contrast are best seen. Applicable to series with CT, MRI and X-ray modalities.



The following outlines how to view multiframe series. Viewing multiphase series of studies is done in the same way.



**Hight-density tissue (e.g. bone) images may be subtracted from the images of contrast-enhanced vessels, which will lead to data loss.**

### 2.28.1 Single-image subtraction view

For studies containing multiframe series with a varying concentration of a contrast agent, one of the frames is subtracted from all frames in the series. To apply the DSA mode:

1. Open the series of study in the View Flat Images window.
2. Click on the **Digital Subtraction Angiography (DSA)**  button. The first frame of the series has been subtracted from all the frames of this series.
3. Scroll through the frames by moving the slider or rotating the mouse wheel, hovering the cursor over the scroll bar on the Frame Scroll Bar (Fig. 2.85).
4. If you want to subtract another frame from all the frames, select this image using the scroll bar in the Frame Scroll Bar, click on the arrow on the right side of the  button and select the command **Set the current frame as a key frame**.
5. If the series frames are offset relative to each other, then correct it by selecting the command **Auto adjust key image offset** from the **Digital Subtraction Angiography (DSA)** tool menu.
6. To manually correct the offset, select the command **Manual Adjustment** from the **Digital Subtraction Angiography (DSA)** tool menu and change the location of the frames using the buttons that appear in the image view window (Fig. 2.86) or using the



keys.

7. If necessary, change the window width and the window level.

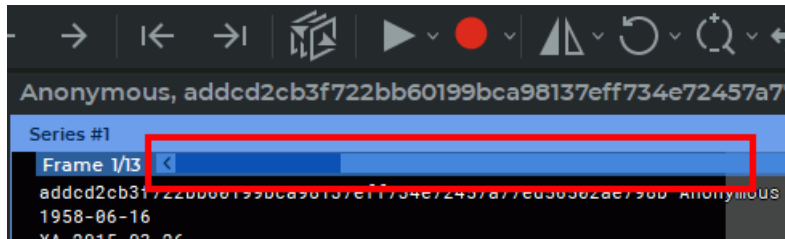

Figure 2.85: Frame Scroll Bar

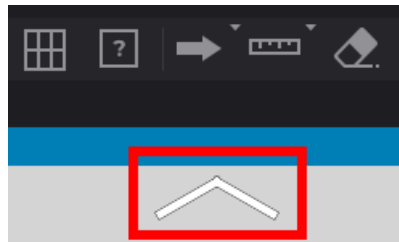

Figure 2.86: The button for manual adjustment is highlighted in red

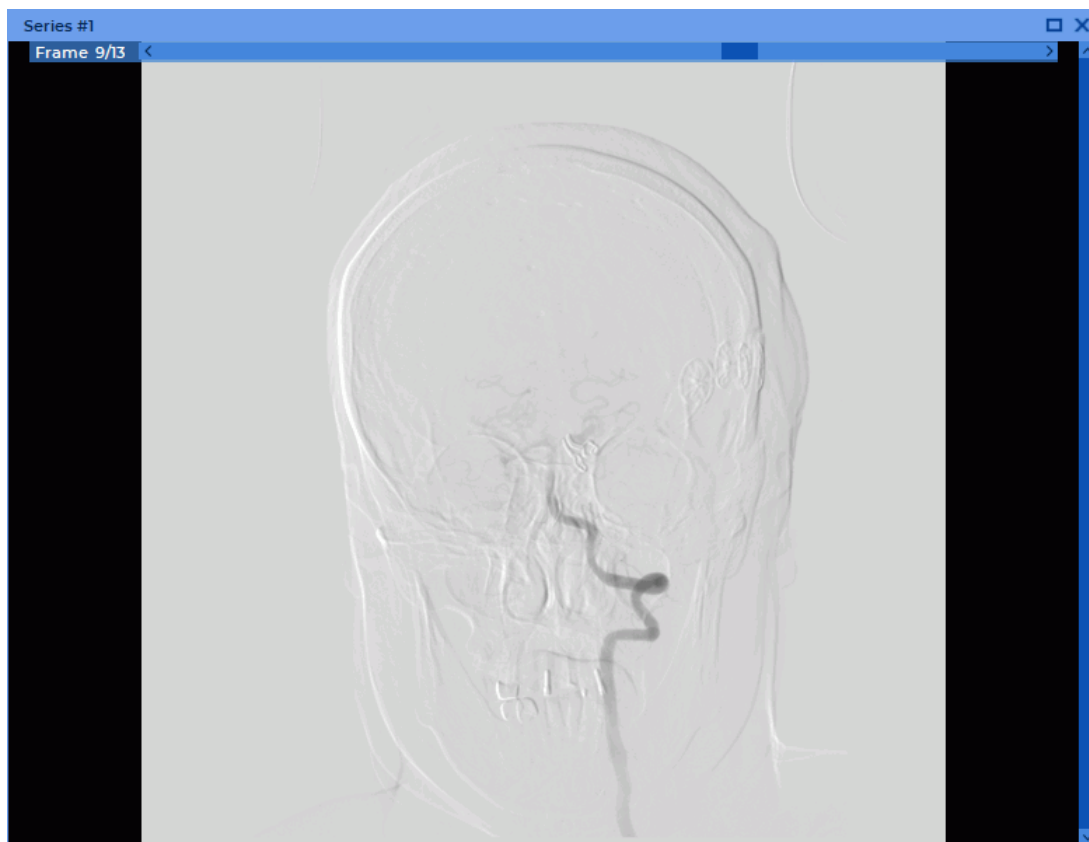



Figure 2.87: View tissues with a varying concentration of a contrast agent in DSA mode

### 2.28.2 Series subtraction view



For studies containing at least two related series of frames and images with different concentrations of a contrast agent, the frames and images of one series are subtracted from the corresponding frames and images of the other series. To apply the DSA mode:

1. Open the series of study in the View Flat Images window.
2. Choose a series whose images you want to subtract from the images of the other series.
3. Click on the  button.
4. Click on the arrow on the right side of the **Digital Subtraction Angiography (DSA)**  button. If the series contains the necessary data, then the command **Set the frame series as key frames** is available. Select this command.
5. Select another series of frames by rotating the mouse wheel or moving the slider on the right side of the image view window.
6. Scroll through the images by moving the slider or rotating the mouse wheel, hovering the cursor over the scroll bar on the Frame Scroll Bar (Fig. 2.85).
7. If necessary, change the window width and the window level.

This tool is also available from the **Image** main menu item.

### 2.28.3 Viewing Several Series of the Same Study Fused in One Multiphase Series with Subtraction

A fused series may be viewed in the digital subtraction angiography (DSA) mode and used for assessment of contrast distribution in tissues at regular time intervals.

1. Open a fused series in the flat image viewer mode (see Section 2.12).
2. Scroll the phases and images of the series by moving the sliders on the phases and images scroll bars.
3. Activate the DSA mode by clicking the **Digital Subtraction Angiography (DSA)**  button.
4. Chose a phase whose images are to be subtracted from the images belonging to other phases. Click the arrow on the right-hand side of the  button and select the **Set the current frame as a key frame** option on the tool menu.
5. Change the window width and level if required.

This tool is also available from the **Image** main menu item.

## 2.29 Image Information in the Series Window

### 2.29.1 Orientation Cube

The **Orientation Cube** is located in the bottom right-hand corner (Fig. 2.88). The markers on the cube show the side the image is viewed from:

A — Anterior

R — Right

L — Left

P — Posterior

F — Foot

H — Head.

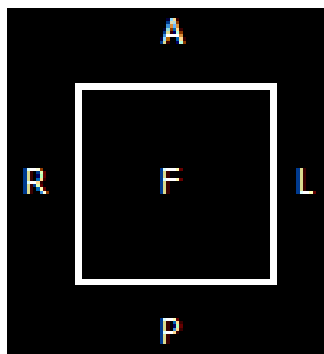

Figure 2.88: Orientation cube

If «F» is written on the cube face, it means that the image is viewed from below; if «R» is written beside a rib, it means that the patient's right side is on this side of the image.

For details on the display settings for the orientation cube and letters (markers), see Section 2.26.

### 2.29.2 Scale

A graduated 10-cm scale is displayed on the right side of the window.

### 2.29.3 Image Information

The image information is displayed in the bottom left-hand corner. It may include the following parameters, depending on the study type:

- **Image No** — current image number in the series/total number of images in the series;
- **Image size** — image size (pixels);

- **FOV (field of vision)** — image size (millimeters);
- **Location** — image location determined by the device;
- **Thickness** — interval between slices.

For details on customizing the data concerning the image, see Section [2.26](#).

### 2.29.4 Patient Information

The information about the patient is displayed in the top left-hand corner.

For details on customizing the data concerning the patient (the patient ID, name, age, date of birth etc.), see Section [2.26](#).

## 2.30 View DICOM Tags

To view the DICOM tags of the image:

1. Open the image.
2. Open the image context menu by right-clicking on the image.
3. Select the **Show image tags** item. The DICOM tags will be displayed in a new tab (see Section [17](#)).

## 2.31 Viewing Structured Reports

Structured reports are used for transferring and storing structured medical documents.

A structured report contains information on the patient and the study. Series of structured reports have **SR** modality.

To view a structured report, open an SR series (see Section [2.1](#)).

A series is opened in a new flat image viewer tab, in a separate window (Fig. [2.89](#)).



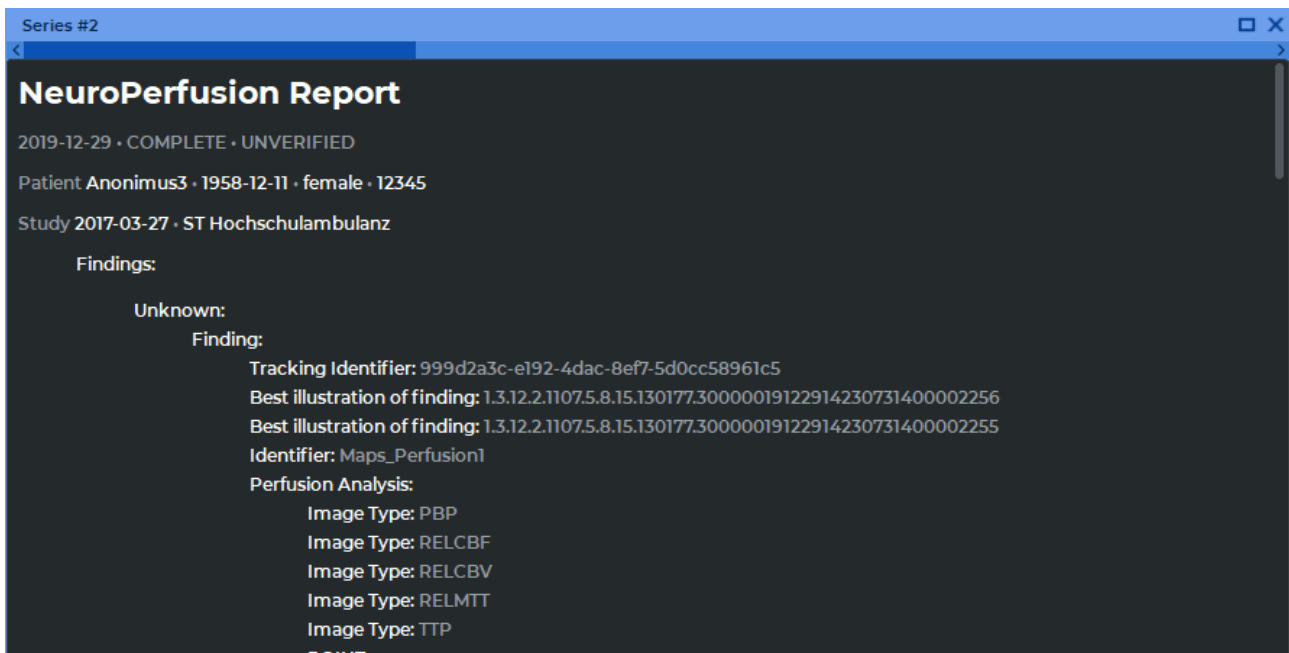

Figure 2.89: Window for viewing structured reports

In the structured reports viewer window, you can choose the mode for arranging series (see Section 2.10). The automatic mode is selected by default.

At the top of the structured reports viewer window, you can see general information on the patient, the study, and the report status. In the lower part of the window, you can see structured information.

If an SR series comprises more than one document, you will see a horizontal scroll bar at the top of the window. The order of the documents depends on the names of the files containing such documents. There are several ways to switch between documents:

- by moving the slider;
- by hovering over the scroll bar and scrolling the mouse wheel;
- with the help of **Switch to previous image** ← and **Switch to next image** → buttons on the toolbar.

Structured reports cannot be edited. The data can be copied to the clipboard and then inserted in the report editor (see Chapter 18) or in any text editor. There are two ways to copy text from the structured reports viewer window to the clipboard:

- select the text, open the context menu by right-clicking on the text, and click **Copy**;
- select the text and press **Ctrl+C** on the keyboard.

There are several methods to select text in the structured reports viewer window:

- to select a word, double-click on that word with the left mouse button;
- to select a line, click three times on any word in that line with the left mouse button;

- to select a text fragment, place the cursor before the first word of the fragment, click the left mouse button and drag the cursor to the end of the fragment while holding the button;
- to select the complete text of the document, open the context menu by right-clicking within the window and choose **Select all**. Alternatively, you can press the **Ctrl+A** combination on the keyboard.

To maximize the report window and restore its size, proceed as follows:

- double-click with the left mouse button on the title of the series window;
- click on the **Expand**  button in the right-hand upper corner of the series window.

To close the window with structured reports, click the **Close**  button on the right-hand side of the window header.

## 2.32 Graphic Label Tool

### 2.32.1 General

This tool allows you to create graphic labels (as arrows, ellipses, polygons, freeform lines and text fields) on an image. The labels will be applied during the entire session of working with the series. The labels are attached to specific points on the image and panned, scaled or rotated together with the image.

The button design depends on the selected tool. The default tool is **Arrow**, and the tool selection button looks like this: .

To activate/deactivate the selected tool, click on the graphic label tool selection button. To select and activate one of the tools, click on the right side of the tool selection button and select the tool (Fig. 2.90).

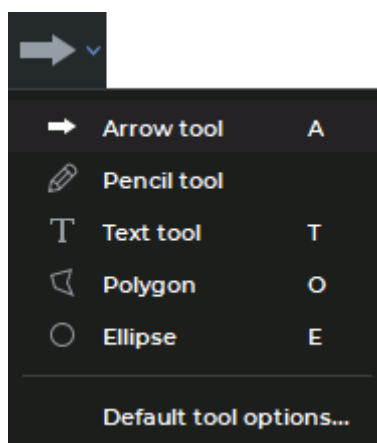



Figure 2.90: Graphic label tool menu

This tool is also available from the image context menu and from the **Image** main menu item.

The annotation tools are available on the **MPR reconstruction, Vessel analysis, Coronary artery analysis, Cardiac function analysis** and **PET Analysis** tabs.

### 2.32.2 Create Labels

To create a label on an image:

1. Activate the **Arrow** tool by clicking the left/right/middle mouse button. The button will look as follows: . To continue work with this tool, use the button with which the tool was activated. To learn more about tool control, see Section 1.14.
2. You can draw an arrow in two ways:
  - Click the mouse button at the point where the arrow tip is to be placed and, while holding the mouse button, move the cursor to the opposite end of the arrow. To fix the point, release the mouse button.
  - Click the mouse button at the point where the arrow tip is to be placed. Click the mouse button again where the opposite end of the arrow should be placed. The arrow is shown in Fig. 2.91.
3. To cancel an incomplete creation, press **Esc**.

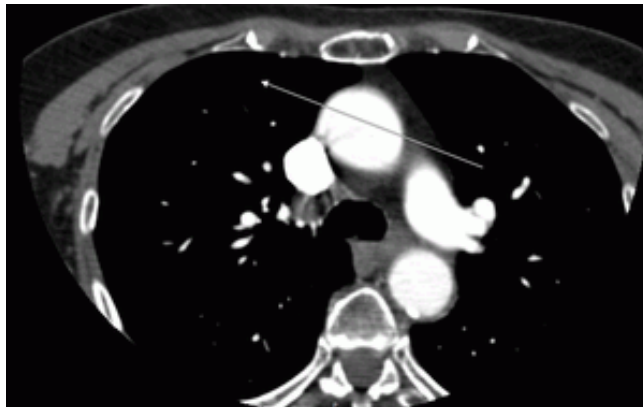

*Figure 2.91: Arrow*

To create a freeform shapes and lines on an image:

1. Activate the **Pencil** tool by clicking the left/right/middle mouse button. The button will look as follows: . To continue work with this tool, use the button with which the tool was activated. To learn more about tool control, see Section 1.14.
2. Click the mouse button at the point where you want the line to begin and, while holding the mouse button, move the cursor. This displays a line that follows the cursor trajectory. To complete the drawing, release the mouse button.
3. To cancel an incomplete creation, press **Esc**.

To create a text label on an image:

1. Activate the **Text** tool by clicking the left/right/middle mouse button. The button will look as follows: **T** . To continue work with this tool, use the button with which the tool was activated. To learn more about tool control, see Section 1.14.
2. Click the mouse button where the text should be located.
3. Enter text in the **Edit text** dialog box and click **OK** to add it to the image or **CANCEL** to cancel the action.

To create a polygon on an image:

1. Activate the **Polygon** tool by clicking the left/right/middle mouse button. The button will look as follows:  . To continue work with this tool, use the button with which the tool was activated. To learn more about tool control, see Section 1.14.
2. Click the mouse button where the first point of the polygon should be located.
3. Move the cursor to the location of the next point. The lines connecting the points of the polygon will be displayed on the screen.
4. Click the mouse button to save the point.
5. Repeat Steps 3 and 4 until the last but one point is set.
6. Double-click the mouse to create the last point. The polygon is complete (Fig. 2.92).
7. To cancel an incomplete creation, press **Esc**.

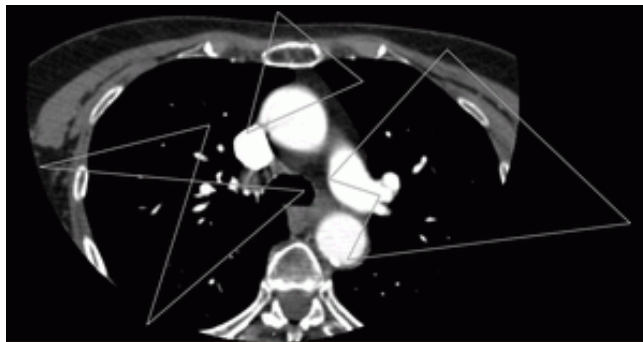
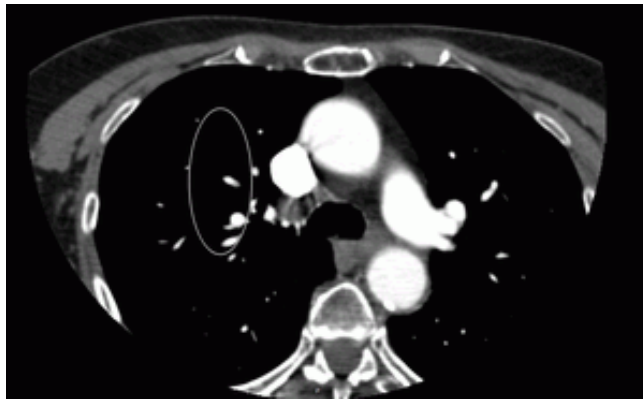

*Figure 2.92: Polygon labels*

To create an ellipse on an image:

1. Activate the **Ellipse** tool by clicking the left/right/middle mouse button. The button will look as follows:  . To continue work with this tool, use the button with which the tool was activated. To learn more about tool control, see Section 1.14.
2. To build an ellipse, just build the rectangle the ellipse is inscribed into. You can draw an ellipse in two ways:

- Click the mouse button to mark the first end of the ellipse and while holding the mouse button move the cursor to the place where the opposite end should be located. The ellipse will be displayed on the screen. To fix the point, release the mouse button.
  - Click the mouse button to mark the first end of the ellipse. Move the cursor to the place where the opposite end of the ellipse should be located. The ellipse will be displayed on the screen. To fix the second end of the ellipse, click the mouse button. The ellipse is shown in Fig. 2.93.
3. To cancel an incomplete creation, press **Esc**.





*Figure 2.93: Ellipse label*

### 2.32.3 Actions with Labels

The DICOM Viewer allows you to perform the following actions with labels:

- Drag. Locate the cursor on the figure line or text and drag the object, holding down the left mouse button or the button to which this tool is assigned.
- Drag a point (an apex for an arrow or polygon and a rectangle apex for an ellipse). Locate the cursor on a point and drag the point, holding down the left mouse button or the button to which this tool is assigned.
- Delete. Locate the cursor on the label border and press the **Delete** key on the keyboard, or right-click the mouse and select the **Remove object** item from the context menu.
- Set render params. Locate the cursor on the label border, right-click the mouse and select the **Tool options...** item from the context menu. In the dialog box that appears, set the line color and thickness for a figure or the font color and size for text. If the box **Set as default** checked, these settings will be applied by default when creating new annotations. Click **OK** to apply the changes or **CANCEL** to cancel the actions.
- Edit text label. Locate the cursor on the text, right-click the mouse, and select the **Edit text** command from the context menu.

To set the default render parameters, click on the right side of the  button and select the command **Default tool options...**

To delete all objects, click the **Delete all annotations and measurements**  button. In the dialog box that appears, Click **YES** to delete or **NO** to cancel. If you want the DICOM Viewer to always delete annotations and measurements without this confirmation, check the box **Don't show this dialog again** and click **YES**. If you want the DICOM Viewer to show the confirmation dialog, check the box **Ask before deleting all annotations and measurements** (see Section 16.7.1).





**Attention! All measurements and other objects created manually will be deleted.**

## 2.33 Synchronize Images

Synchronization is applied if two or more series are opened for the same study. This function allows you to scroll images in several series synchronously. By default the option is enabled.

To set up the synchronization options you need, proceed as follows:

1. Click on the arrow on the right side of the **Sync series**  button on the toolbar. This tool is also available from the **Image** main menu item.
2. In the drop-down menu for the  button (Fig. 2.33), choose the synchronization types and modes:

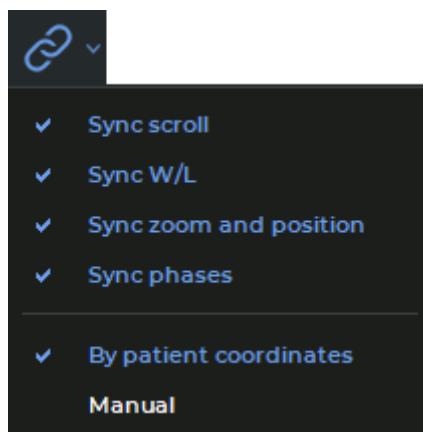



Figure 2.94: Activating the image synchronization types and modes

- **Sync scroll.** Provides an opportunity to scroll images from the series with the same *frameOfReferenceUid* tag values simultaneously in the **By patient coordinates** mode. If the *frameOfReferenceUid* tag values are different for different series, scrolling will not be synchronized in the **By patient coordinates** mode. To synchronize series with different *frameOfReferenceUid* tag values, select the **Manual** mode.

Synchronization is performed for the sections parallel to the synchronizing section;

- **Sync W/L.** Window width and level (W/L) synchronization is performed for the series with **CT** modality. For series with other modality types, synchronization will only be performed if the recommended window width and level (W/L) values are the same. The mode chosen does not impact this synchronization type;
- **Sync zoom and position.** Provides an opportunity to synchronize image scaling and moving. This option will work differently depending on the mode chosen.
  - In the **By patient coordinates** mode:
    - \* image scaling and moving is synchronized for the images from the series with the same *frameOfReferenceUid* tag values. If the *frameOfReferenceUid* tag values are different, synchronization will not be performed;
    - \* the real size of the image is taken into account. For sections of the same size, objects are displayed in the same way;
    - \* the centers of the windows are synchronized. In the window center, you see the projection of the center point of the synchronizing window on the synchronized window section;
    - \* if the **Synchronize scale and position of slices in different projections** option on the **Tools** tab of the **Image viewer** module (for details see Section 16.7.1) is disabled, synchronization will only be performed for the sections parallel to the synchronizing section. If this option is enabled, parallel orientation of the sections will not be taken into account for scaling and position synchronization.
  - In the **Manual** mode:
    - \* the real size of the image is taken into account. For sections of the same size, objects are displayed in the same way;
    - \* if the position of the synchronizing window center is changed, the position of the synchronized window center is changed accordingly;
    - \* if the **Synchronize scale and position of slices in different projections** option on the **Tools** tab of the **Image viewer** module (for details see Section 16.7.1) is disabled, synchronization will only be performed for the sections parallel to the synchronizing section. If this option is enabled, parallel orientation of the sections will not be taken into account for scaling and position synchronization.
- **Sync phases.** The image phases are synchronized by number. If the phase number for the synchronizing series is greater than the total number of phases in the synchronized series, then the phase with the greatest number will be selected for the synchronized series. The mode chosen does not impact this synchronization type.

If there are several images in the window, then the properties of the first image will be used for scaling and movement evaluation.

Image synchronization is performed automatically. To disable synchronization, click on the **Sync series**  button.

To disable the default synchronization on the DICOM Viewer startup, uncheck the **Turn on sync image by default** box in the image viewer setup dialog box (see Section 16.7.1).

## 2.34 Synchronization by a Point



To choose the slices in all the windows that are the closest to the point selected, use the **Sync by point**  tool. To synchronize, choose a reference point in one of the viewer windows. You will see crosshairs at this point. The synchronized windows will show the slices that are the closest to the point chosen; you will see crosshairs at the closest point of the synchronized slice.



**If the reference point is not present on the synchronized slice, the crosshairs shown will have a black spot in the centre**

The slice thickness is determined by the modality.

## 2.35 Mirror Image Horizontally/Vertically

This tool allows you to mirror images. The button will look different depending on the mode that was used last (  — horizontal,  — vertical). The horizontal mode is used by default.

To activate/deactivate the tool, click on the button. If several series are opened in the view window, the mirroring is activated for each series independently.

To change the mirroring mode, click on the arrow on the right side of the button and check the required mode. Both modes can be activated simultaneously.

This tool is also available from the **Image** main menu item.

## 2.36 Calibration sizes

X-ray image sizes are increased as compared with the real size of the tissues (Fig. 2.95).

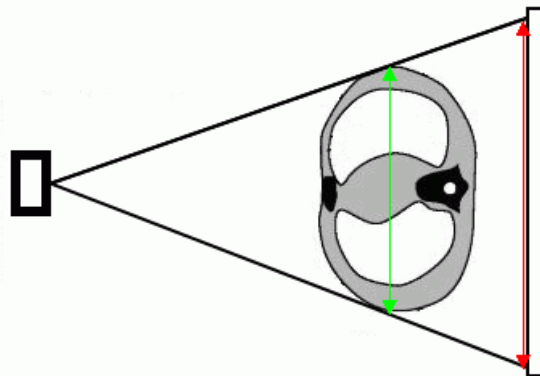

*Figure 2.95: The green arrow shows the actual size of the tissues and red arrow shows the size of the image*

Hence, the size determined by X-ray modality may be incorrect. If a picture contains an object whose size is known (e.g., a catheter), it is possible to calibrate the image size. To calibrate the size:



1. Select the **Images** main menu and the **Calibration** tool.
2. A calibration segment can be built in two ways:
  - Mark the first point by clicking the left mouse button. Drag the cursor over the screen. The distance from the first point to the current point will be displayed beside the line. To fix the second point, click the left mouse button.
  - Click the mouse button at the first point of the calibration segment and move the cursor to the endpoint while holding the mouse button. The distance from the first point to the current point will be displayed beside the line. To fix the endpoint, release the mouse button.
3. In the dialog box that appears, type the real length of the interval constructed (Fig. 2.96). To calibrate the size, click **OK**, to cancel, click **Cancel**.

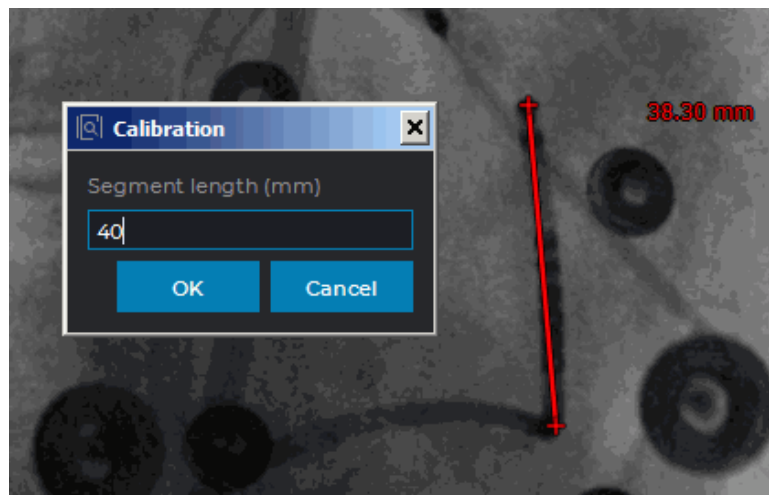

Figure 2.96: Calibration size

If you cancel the calibration, the calibration interval remains in the image. To hide the calibration interval, put the cursor on it and press the **Delete** key on the keyboard, or right-click the mouse and select the **Remove object** item on the context menu. This calibration will remain.

To deactivate the **Calibration** tool, select it again in the **Image** main menu. This calibration will remain.

Calibration is factored in for measurements that depend on linear dimensions. After calibration, previously made measurements are automatically adjusted.

Calibration is maintained until the window containing the current series is open.

## 2.37 Apparent diffusion coefficient

---

Functionality is available in the **Pro** edition

---

DICOM Viewer allows to show parametric maps for diffusion-weighted images. To activate the ADC mode, click on the **Apparent diffusion coefficient (ADC) map**  button.



**The mode is available for MRI study series containing information on the «b» value (Diffusion sensitization factor).**

To set values factor, click on the arrow on the right side of the button and select the **Set values factor...** item.

---

## Chapter 3

# Volume Reconstruction



**In Volume Reconstruction window, diagnosis can only be established on the basis of CT, MR, MG, and XA series.**



**The DICOM Viewer supports 16-bit images. If the source data width is significant, data may be partially lost.**

It is recommended to use a render device supporting the CUDA technology (preferable) or the OpenCL technology to build a volume model. The settings are described in Section [16.7.3](#).

On macOS 10.15 and later, it is recommended to use a visualization device that supports Metal polygonal and voxel rendering. The settings are described in Section [16.7.3](#).



**Color tables are needed for displaying voxels representing different density values in different colors for improved perception. The shades on the screen are different from the real shades.**

### 3.1 View Images

To open a study in the volume reconstruction window:

1. Load the studies to the DICOM Viewer.
2. Select the study from the study panel.
3. Click the **Volume Reconstruction**  button on the toolbar. To select the tab location (in the current window, in a separate window, or in the full screen mode), click on the arrow on the right side of the button. To open the volume reconstruction window in a new tab in the current window, click on the button. This process may take some time.

Fig. 3.1 illustrates the volume reconstruction window. The right side of the screen displays the toolbar with the volume edit tools and the windows for viewing the axial, frontal and sagittal sections. You can work with the sections in the 3D cursor mode described in Section 5.5.1.

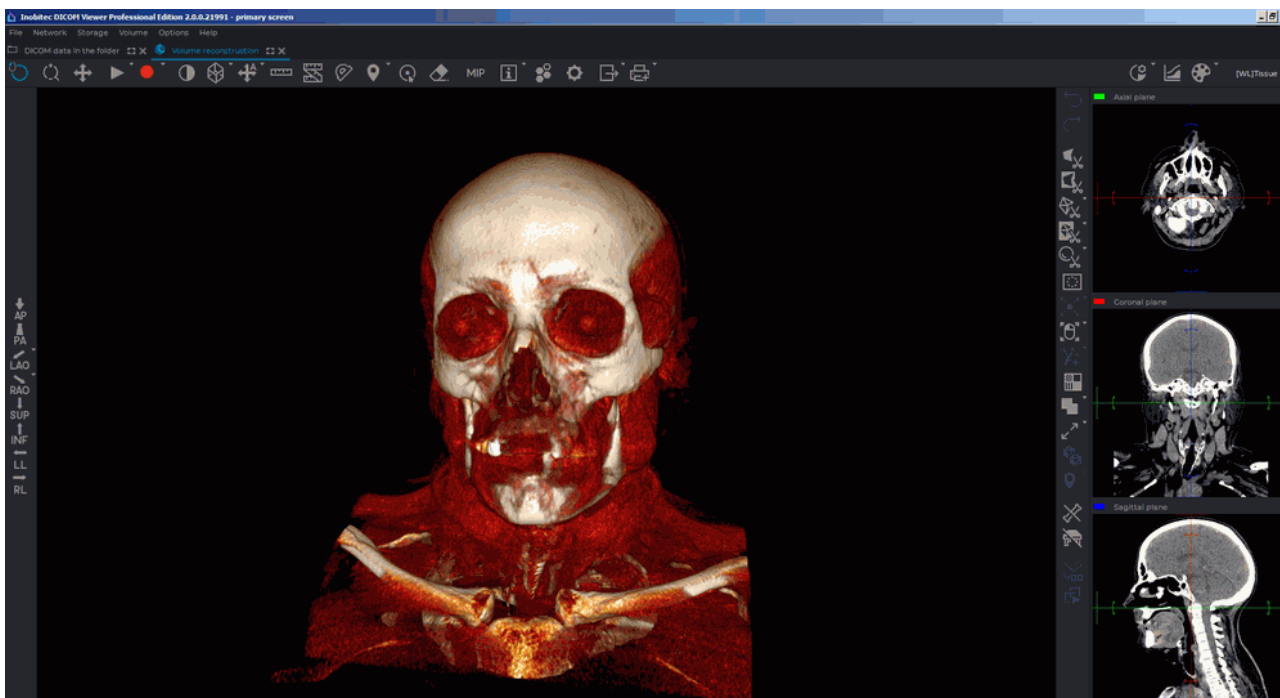



Figure 3.1: Volume reconstruction tab

The right side of the screen displays the toolbar with the volume edit tools and the windows for viewing the axial, frontal and sagittal sections. You can work with the sections in the 3D cursor mode described in Section 5.5.1.



The volume reconstruction of tissues is located on the left side of the screen.

To move the cursor in **MPR reconstruction** windows, to move the cursor to a point on the model, activate the  **Select model point** tool and click the mouse button to select the desired point. To deactivate the tool, click the  button again. For details on setting and operating the **Select model point** tool, see in Section 3.5.

The tool is also available in the **Volume** section of the main menu.

## 3.2 Model Projection

The DICOM Viewer creates an opportunity to show the model in the perspective (Fig. 3.3) and parallel (Fig. 3.2) projection. The button will look different depending on the projection selected:

	<b>Switch to parallel projection.</b> The perspective projection is now selected (selected by default)
	<b>Switch to perspective projection.</b> The parallel projection is now selected

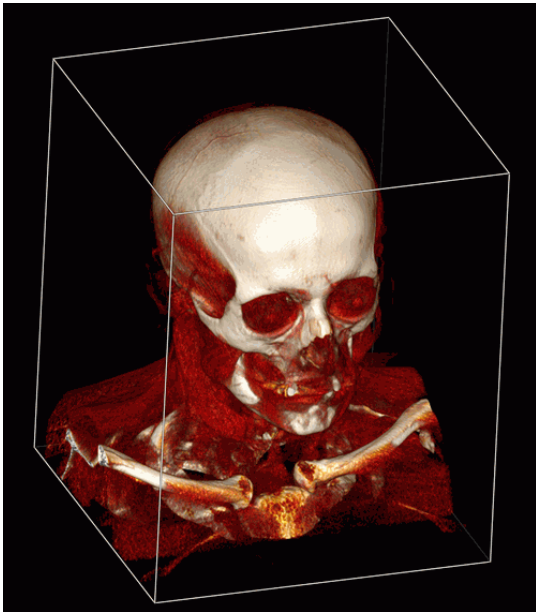

Figure 3.2: Parallel projection of the 3D model

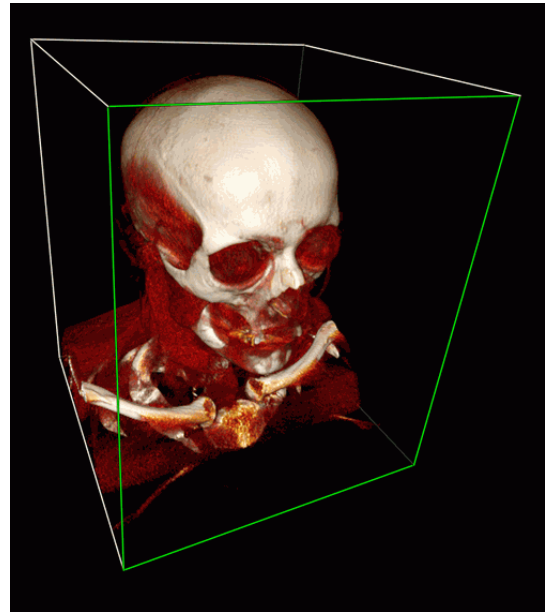





Figure 3.3: Perspective projection of the 3D model

The **Clipping Box** tool in Fig. 3.2 and Fig. 3.3 is included for clarity and described in detail in Section 3.10.

### 3.3 Actions with Model

The DICOM Viewer allows you to perform the following actions with a model:

- Pan leftward and rightward using the   keys.
- Zoom the 3D image by rolling the mouse wheel or using the   keys.
- Rotate by moving the mouse holding the wheel or using the **Rotate** tool (see Section 3.4.2).

On the left-hand side of the window, you can see a standard space orientation panel (Fig. 3.4). To jump to a different space orientation option, click the buttons on the panel. To

open additional options for the «**LAO**» and «**RAO**» buttons, click the arrow on the right side of the corresponding button. By clicking the buttons on the panel, you can only work with the window in which the panel is placed.



Figure 3.4: Space orientation selection buttons

The panel with space orientation selection buttons (Fig. 3.4) is available in the **Volume reconstruction** and **3D view** windows of the **MPR reconstruction**, **Vessel analysis** and **Coronary artery analysis** tabs. You can set the visibility of the standard space orientation panel in the **UI** tab. To do that, go to the **3D reconstruction** and **Vessel analysis** module settings (see Sections 16.7.3 and 16.7.4).

## 3.4 Model Positioning Tools

### 3.4.1 Model Shift

There are two ways to move the model in the volume reconstruction window:

1. Move the mouse holding the wheel and the **Shift** key on the keyboard. This key combination is set by default. You can disable or change the setting in the **3D controllers** tab of the **3D reconstruction** module (see Section 16.7.3).
2. Activate the **Pan**  tool on the toolbar by clicking the left/right/middle mouse button. To continue work with this tool, use the button with which the tool was activated. To learn more about tool control, see Section 1.14. To move a model, move the cursor around the screen while holding down the mouse button.

This tool is also available from the image context menu.

### 3.4.2 Model Rotation

Activate/deactivate the **Rotate**  tool by clicking the left/right/middle mouse button. By default, the tool is active. To continue work with this tool, use the button with which the tool was activated. To learn more about tool control, see Section 1.14.

Note that the initial point of the cursor does not affect the rotation. If the cursor is moved vertically, the image is rotated round the horizontal axis. If the cursor is moved horizontally, the image is rotated round the vertical axis. That is, the image follows the cursor. If the cursor moves along a slanting line, the image slants the same way.

This tool is also available from the image context menu and from the **Volume** main menu item. Activation is only possible with the left mouse button.

### 3.4.3 Model Scaling

The tool allows you to zoom the model with the mouse, holding the button. Move the cursor up to zoom in or down to zoom out.

Activate/deactivate the **Zoom**  tool by clicking the left/right/middle mouse button. To continue work with this tool, use the button with which the tool was activated. To learn more about tool control, see Section 1.14.

This tool is also available from the image context menu and from the **Volume** main menu item.

## 3.5 «Select Model Point» Tool

The **Select model point**  tool is available on the toolbar in the **Volume reconstruction** and **MPR reconstruction** tabs. In the **MPR reconstruction** tab, the tool becomes available when the **3D view** mode is chosen. Besides, the tool is available in the **Volume** section of the main menu of the **Volume reconstruction** tab.

Activate the **Select model point**  tool by clicking the left/right/middle mouse button. To continue work with this tool, use the button with which the tool was activated. To learn more about tool control, see Section 1.14.

Mouse over the volume model and choose a point. The point of intersection of the cutting planes in the MPR Reconstruction windows is moved to the specified point on the volume model. The point specified may be used as the initial point for measuring and editing the model volume.





**Attention! For more precise choice of the point on the volume model, provide the correct value of the opacity threshold for the «Render settings» tool (see Section 3.14).**

## 3.6 The Play Tool

The DICOM Viewer allows you to automatically rotate a volume model around one of the three orthogonal axes relative to the center, or play phases. The center of the model can be changed using the **Center** tool (see Section 3.9). To configure playback, click the arrow on

the right side of the **Play**  button and specify the necessary parameters in the button context menu.

1. If the series contains several phases, then the DICOM Viewer allows you to switch between the model rotation and the phase playback. To switch between these modes, select the **Play phases** or the **Volume rotation** item from the **Play** button context menu. The selected item is marked with a flag. Only items suitable for this series are available on the context menu.
2. Select the speed (5, 10, 20 or 25 frames per second only for the phase playback). If you want to set a different playback speed, select the **User defined...** item and in the dialog that opens set the value from 1 to 100. The selected speed will be marked with a flag.
3. If you want to play phases cyclically, select the **Loop** item. The item will be marked with a flag. To disable the cyclic playback, select this command again. The flag will be removed.
4. To select the rotation axis of the model, select the **Settings...** command; in the dialog that opens, select the axis from the **Axis** drop-down list and click **OK** to apply the setting or **CANCEL** to cancel.
5. To adjust the rotation speed of the model select the **Settings...** command; in the dialog that opens, enter a value in the **Degrees per second** field and click **OK** to apply the setting or **CANCEL** to cancel.

To start playback, click on the  **Play** button on the toolbar. During playback, the button looks like  . To end playback, click the  button.

## 3.7 Video recording

---

Functionality is available in the **Pro** edition

---

The DICOM Viewer allows you to record video for the volume model view window. The following objects will be recorded:

- base volume and segmented structures tissues;
- measurements;
- annotations;
- markers;
- clipping box;
- tags;
- orientation cube;
- the **Select model point** tool label.

Other features of the tool are similar to those described in Section [2.15](#).



## 3.8 Cutting Tools

There are several cutting tools on the right toolbar.

### 3.8.1 Polygon Cut

The **Polygon Cut**  tool allows you to build a polygon or an area with smooth borders that the cut area is projected on.

To build a polygon:

1. Activate the **Polygon Cut** tool by clicking the left/right/middle mouse button. To continue work with this tool, use the button with which the tool was activated. To learn more about tool control, see Section 1.14.
2. Click the mouse button to set the apices of the polygon marking the figure to be cut, except the last point.
3. Fix the last point by double-clicking the mouse.
4. To cancel an incomplete building, press **Esc**.

To build an area with smooth borders (Lasso mode):

1. Activate the **Polygon Cut** tool by clicking the left/right/middle mouse button. To continue work with this tool, use the button with which the tool was activated. To learn more about tool control, see Section 1.14.
2. Press and hold the **Shift** key on the keyboard.
3. Circle the area to be cut, holding down the mouse button.
4. To complete the building, release the mouse button or click another mouse button.
5. To cancel an incomplete building, press **Esc**.

The part of the model to be projected on the area will be cut.

### 3.8.2 Inverse Polygon Cut

The tool is similar to the previous one, except that the part of the model not to be projected on the area will be cut. To activate/deactivate the tool, use the  button on the toolbar.

### 3.8.3 Cut object

The tool allows you to delete an area of a 3D model not associated with its other parts.

Activate/deactivate the  tool by clicking the left/right/middle mouse button. To continue work with this tool, use the button with which the tool was activated. To learn more about tool control, see Section 1.14.

### 3.8.4 Cut all except object

The tool is similar to the previous one, except that all areas excluding the selected area are deleted. To activate/deactivate the tool, use the  button on the toolbar.

### 3.8.5 Cutting Tools Parameters



For the **Cut object** and **Cut all except object** tools, the following parameters can be set:

1. **Grow from surface (mm)**. The tissue surrounding the deleted area will be deleted too. This parameter specifies the distance from the surface on which the tissue will be deleted. If this parameter is set to zero, the model surface may look rough, so use a value of zero only if necessary.
2. **Min object thickness (mm)**. If the value is greater than zero, the tissue with a thickness less than the set value will be ignored during deletion.



The parameters for each tool are set separately.

To set these parameters, click on the arrow on the right side of the appropriate tool button and select the **Parameters...** item and in the dialog box that appears, specify the required values.

### 3.8.6 Sphere Cut, Sphere Restore and Restore by Mask Tools

The **Brush cut** , **Brush restore**  and **Restore by mask**  tools allow to remove tissue within a sphere or cylinder and restore the tissue deleted by cutting tools. To select one of these tools (**Brush cut**, **Brush restore**, **Restore by mask**) and modes (**Sphere**, **Cylinder**), click the arrow on the right side of the tool buttons. The button will look different depending on the tool that was used last:

The **Brush restore** and **Restore by mask** tools are assigned to the same button. To select a tool, click on the arrow on the right side of the tool selection button. The button looks different, depending on the tool selected:

	<b>Brush restore</b> (is selected by default)
	<b>Restore by mask</b>

To select one of modes (**Sphere**, **Cylinder**), click the arrow on the right side of the tool buttons. The same mode is chosen for **Brush restore** and **Restore by mask** tools.

The cursor will look different depending on the mode that is selected. The cursor for the **Sphere** mode is shown in Fig. 3.5, and the cursor for the **Cylinder** mode is shown in Fig. 3.6.



Figure 3.5: The cursor for Sphere mode

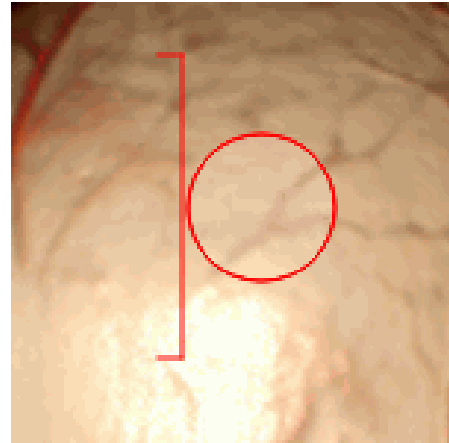





Figure 3.6: The cursor for Cylinder mode

To activate/deactivate the tool, click on the tool button. If any tool is activated, the button is highlighted.

To cut tissue:

1. Activate the  **Brush cut** tool by clicking the left/right/middle mouse button. To continue work with this tool, use the button with which the tool was activated. To learn more about tool control, see Section 1.14.
2. Set the tool diameter, moving the mouse while holding the **Alt** key. The **Brush cut** and **Brush restore** tools are set to the same diameter value.
3. For the **Cylinder** mode, set the height if it is necessary. To do it, click the arrow on the right side of the tool button and select the **Cylinder settings...** item. In the dialog box that appears, set the cut height.
4. Click the mouse button in the place where you want to cut tissue. Part of the tissue will be cut. The green dot indicates where the great circle of the sphere (the base area of the cylinder) touches the surface of the model. The great circle passes through the center of the sphere and is parallel to the plane of the screen.
5. Repeat steps 2 and 4 if necessary.







The **Brush restore**  tool allows you to perform the reverse process of brush cutting.

The **Restore by mask**  tool allows you to restore tissue by mask (this tool is used for segmentation). If mask is not set, this mode is analogous to the **Brush restore** mode. For details how to set mask, see Section 6.2.4.

### 3.8.7 Tools for intelligent volume editing

Functionality is available in the **Pro** edition

The **Grow (dilation)**, **Shrink (erosion)**, **Fill** and **Cut invisible volume** tools allow to edit tissue within special algorithms. The **Multi-segment growing (Voronoi diagram)** tool allows you to edit segmented structures. To select one of these tools, click the arrow on the right side of the tool buttons. The button will look different depending on the tool that was used last:

	<b>Grow (dilation)</b> (set by default)
	<b>Shrink (erosion)</b>
	<b>Remove noise (opening)</b>
	<b>Remove holes (closing)</b>
	<b>Multi-segment growing (Voronoi diagram)</b>
	<b>Fill</b>
	<b>Cut invisible volume</b>

The **Grow (dilation)** tool allows you to increase the volume by a certain value from the surface in one iteration. This value is specified in the **Settings** menu of this tool (parameter **Growing radius**). The increase is possible only within the original volume, for example, after the use of cutting tools. When you use this tool to edit a segmented structure, an increase is possible only within the mask. The tool is used to fine-tune the structure if, initially, the required volume was not obtained.

The **Shrink (erosion)** tool performs the opposite action. The reduction value is specified by the parameter **Growing/Shrinking radius**.

The **Remove noise (opening)** tool allows to remove noise from the volume. This tool is equivalent to the consistently applied tools **Shrink (erosion)** and **Grow (dilation)**.

The **Remove holes (closing)** tool allows to remove little holes from the volume. This tool is equivalent to the consistently applied tools **Grow (dilation)** and **Shrink (erosion)**.

Each time the **Grow (dilation)**, **Shrink (erosion)**, **Remove noise (opening)**, and **Remove holes (closing)** tools are used, a dialog box (Fig. 3.7), in which the operation radius should be set in millimeters or voxels is displayed.

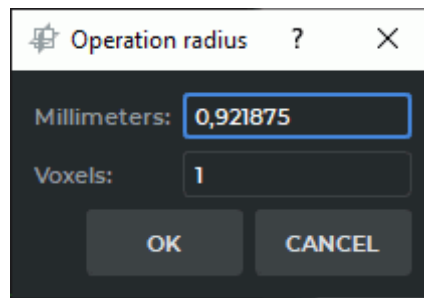



Figure 3.7: Operation radius dialog box

The **Multi-Segment Growing (Voronoi diagram)** tool allows you to simultaneously build several structures and base volume. It is used to edit segmented structures (see Section 6.8.6). If the tool is applied only to the base volume, then it works like the **Grow (dilation)** tool.

The **Fill** tool allows you to fill the voids in the volume. If you are working with segmented structures, the tool is used to improve structures, built on a «grainy» mask. Such masks are typical, for example, for kidneys.



The **Cut invisible volume** tool sets the mask according to the visible volume.

### 3.8.8 Remove Table

The tool allows you to delete areas resembling the medical equipment table. To delete, click the  button on the toolbar.





**Some objects that have been misrecognized as the modality table may be deleted by mistake.**

To undo or redo the last action associated with cutting, use the **Undo**  and **Redo**  buttons.

## 3.9 Center

The tool allows you to set the center point. The model rotates and scales with respect to this point. This may be necessary if the model is altered with cutting tools. The tool has two modes: auto and interactive (manual). To select mode, click on the arrow on the right side of the **Center**  button on the toolbar and select the mode. The current mode is marked with a flag.

Centering is performed in space. Depth centering can be disabled. To enable/disable depth centering, click on the arrow on the right side of the **Center**  button and select the **Center depth** item. If depth centering is enabled, the item is marked with a flag. Centering in a plane parallel to the screen plane is always performed.

To activate the tool, click on the **Center**  button. If the auto mode is selected, activate the tool by clicking the left/right/middle mouse button. To continue work with this tool, use the button with which the tool was activated. To learn more about tool control, see Section 1.14. If

the auto mode is selected, centering will be performed immediately after the tool is activated. If the interactive mode is selected, the cursor takes the form of a crosshair. Set the center point by clicking on it with the left mouse button.

To center the model without activating the tool, press **Alt + middle mouse button**. To do this, click the middle mouse button while holding the **Alt** key on the keyboard. When you click on a selected point, the visible model will be centered with respect to this point. When you click on the screen beyond the model, the model will be centered with respect to the center of the visible part.

### 3.10 Clipping Box

The clipping box allows you to cut off all tissues outside it. To build a box, click on the **Clipping Box**  button on the toolbar by clicking the left/right/middle mouse button. To continue work with this tool, use the button with which the tool was activated. To learn more about tool control, see Section 1.14.

To build a minimum box not cutting the model, click on the arrow on the right side of the **Clipping Box** button and select the **Fit to model** command.

To build a box by the image borders, click on the arrow on the right side of the **Clipping Box** button and select the **Reset clipping box** command.

To cut off parts of tissues, move the box face so that it intersects the 3D model. To do this, locate the cursor on the box face so that its borders are highlighted in green (Fig. 3.8).

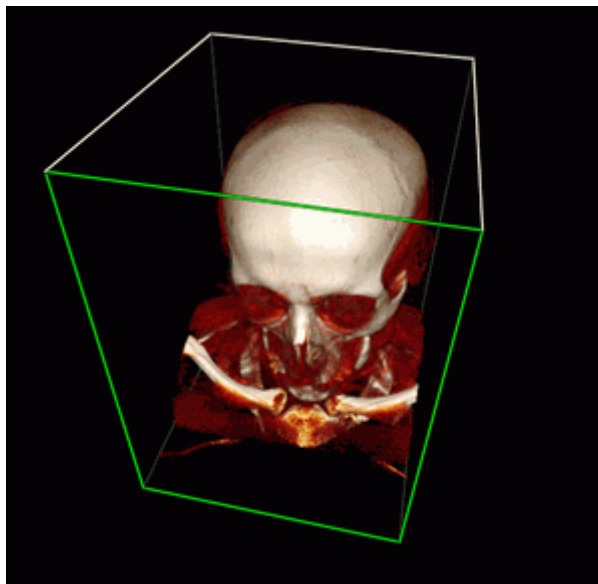

*Figure 3.8: Editing the Clipping Box. The active face ready for moving is highlighted in green*

Next, move the face using the mouse while holding the left button. Only the faces located in the foreground (highlighted in white) can be moved. The faces unavailable for moving are highlighted in grey. To be able to work with the faces that are unavailable for moving, rotate the image. The box is rotated synchronously with the image.

To zoom the box symmetrically, move the mouse, holding the mouse button with which the tool was activated and **Ctrl** key.

To pan the box, move the mouse, holding the mouse button with which the tool was activated and **Shift** key.

To rotate the box, move the mouse, holding the mouse button with which the tool was activated and **Alt** key.

If the **Clipping Box** tool is deactivated, the sections made using the tool will be saved. To restore the initial look of the model, use one of the following options:

1. Activate the **Clipping Box** tool and move the faces to make the model visible.
2. Click on the arrow on the right side of the **Clipping Box** button and select any of the building options. If the **Clipping Box** tool is inactive, the box will not be visualized, but the section will still be reset.

This tool is also available from the **Volume** main menu item.

## 3.11 Measurements

The tool allows you to make linear and polygonal linear measurements of distances in an image.



**The measurement accuracy is up to one screen pixel. As a screen pixel is smaller than a source image pixel, the true linear measurement accuracy is up to one source image pixel. Errors may also occur in density measurements. The most accurate measurements are performed with bilinear interpolation (see Section 2.5).**

### 3.11.1 Ruler

To make linear measurements:

1. Activate the  **Ruler** tool by clicking the left/right/middle mouse button. To continue work with this tool, use the button with which the tool was activated. To learn more about tool control, see Section 1.14.
2. You can measure the distance in two ways:
  - Mark the first point by clicking the mouse button. Drag the cursor over the screen. The distance from the first point to the current point will be displayed beside the line. To fix the current point, click the mouse button.
  - Click on the mouse button at the starting point and move the cursor to the endpoint while holding the mouse button. The distance from the first point to the current point will be displayed beside the line. To fix the endpoint, release the mouse button.
3. To cancel an incomplete measurement, press **Esc**.

To move the ruler border:

1. Locate the cursor on the point to be moved so that it would look like this  .
2. Drag the point, holding the left mouse button.
3. Release the left mouse button.

To delete a ruler:

1. Locate the cursor on the line to be deleted so that it would look like this  .
2. Press the **Delete** key on the keyboard or right-click the mouse and select the **Remove ruler** command.

This tool is also available from the model context menu and from the **Volume** main menu item. Activation is only possible with the left mouse button.

### 3.11.2 Polygonal Ruler

To perform polygonal linear measurement:

1. Activate the  **Polygonal ruler** tool by clicking the left/right/middle mouse button. To continue work with this tool, use the button with which the tool was activated. To learn more about tool control, see Section 1.14.
2. Mark the first point on the toolbar by clicking the mouse button.
3. Drag the cursor over the screen. The distance from the first point to the current point will be displayed beside the line.
4. To fix the current point, click the mouse button.
5. Repeat Steps 3 and 4 until the last but one point is fixed.
6. Fix the last point by double-clicking the mouse.
7. To cancel an incomplete measurement, press **Esc**.

To move the linear measurement point:

1. Locate the cursor on the point to be moved so that it would look like this  .
2. Drag the point, holding the left mouse button.
3. Release the left mouse button.

To delete a point:

1. Locate the cursor on the point to be deleted so that it would look like this  .
2. Right-click the mouse and select the **Remove point** command.

To insert a point:



1. Locate the cursor on the ruler where you want to insert a point so that it would look like this  .
2. Right-click the mouse and select the **Insert point** command.

To resume a completed polygonal linear measurement:

1. Locate the cursor on the point from which you want to continue the measurement, so that it would look as follows:  .
2. Right-click the mouse and select the **Resume ruler** command.
3. Perform the polygonal linear measurement.

To delete a completed polygonal linear measurement:

1. Locate the cursor on the measurement to be deleted so that it would look like this  .
2. Press the **Delete** key on the keyboard or right-click the mouse and select the **Remove ruler** command.

This tool is also available from the model context menu and from the **Volume** main menu item. Activation is only possible with the left mouse button.

### 3.11.3 Surface ruler

Functionality is available in the **Pro** edition

A distance on the surface of a visible volume may only be measured in the **Volume reconstruction** tab.

To measure a distance on the surface of a visible volume or a surface, proceed as follows:

1. Activate the  **Surface ruler** tool by clicking the left/right/middle mouse button. To continue work with this tool, use the button with which the tool was activated. To learn more about tool control, see Section 1.14.
2. Mark the first point on the toolbar by clicking the mouse button.



**There may be a delay before the first point is displayed as it takes some time to bind the first point to the segmented structure.**

3. Drag the cursor over the screen. The next point number is displayed next to the cursor.
4. To fix the current point, click the mouse button.
5. Repeat Steps 3 and 4 until the last but one point is fixed.
6. Fix the last point by double-clicking the mouse.

The line reflecting the change is built along the shortest path between the points on the surface of only one segmented structure. The distance is measured on the surface of the segmented structure where the first point is placed.

Selecting a segmented structure to place the first point is based on the **Point projection** setting of the **Render settings** tool. For details on render setting tool management, see Section 3.14.

If more than one segmented structure is created in the project that satisfies the criterion for placing the first point, the point is placed on the structure located in the foreground. You can measure the distance on the surface of the structure in the background in several ways:

- rotate the volume model so that there are no other structures in front of the selected structure;
- turn off the visibility of the structure in the foreground;
- change the opacity value of the foreground structure.

If the path cannot be built, an **Unable to find the path** message pops up, and the last path that was successfully built is restored. The measurement path is highlighted when you hover over it, and the numbers of the points are shown.



**It is impossible to measure a distance on the surface of a imported or copied surface.**

Imported and copied surfaces are structures without a 3D model. If the user attempts to make a measurement on the surface of an imported/copied surface, a warning message will pop up.

If a measurement path is built on the surface of a segmented structure (base volume, or surface) that is invisible, a warning will pop up if a user attempts to edit the path.

In the merged series opened in the **Volume reconstruction** tab, the distance on the surface of the segmented structure is measured in the same way. The first measurement point along the surface of the structure is placed on the layer that is in the foreground. To measure the distance on the surface of the structure located on the background layer, decrease transparency of the foreground layers.

In addition to commands, the context menu of the **Surface ruler** (Fig. 3.9) contains information concerning the layer and the segmented structure on which the measurement path to be edited was built. To open the context menu for the tool, right-click on a point, the path or the text describing the path length.

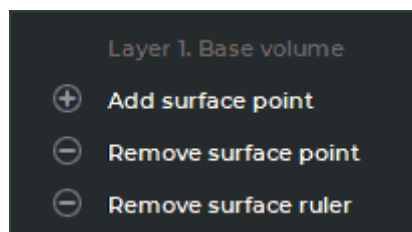



Figure 3.9: The **Surface ruler** context menu

To move a point of a measurement path, proceed as follows:

1. Locate the cursor on the point to be moved so that it would look like this  .
2. Drag the point, holding the left mouse button or the button, with which the tool is activated.

To add a point in order to proceed with building a measurement path, proceed as follows:

1. Locate the cursor over the first or the end point of the measurement path so that it would look like this  .
2. Right-click the mouse and on the context menu select the **Add surface point** command.
3. Proceed with building the measurement path.

To add a new point to a path between two existing points, proceed as follows:

1. Hover the cursor over the place on the path where you want to add a point so that it would look like this  .
2. Right-click the mouse and on the context menu select the **Insert surface point** command.
3. Drag the cursor over the screen. To fix the new point, click the mouse button.



To delete a point:

1. Locate the cursor on the point to be deleted so that it would look like this  .
2. Right-click the mouse and on the context menu select the **Remove surface point** command.

The deletion of a single point does not lead to rebuilding the measurement path completely. Only the segment between the two neighboring points will be rebuilt.

To rebuild the edited measurement path, hover the cursor over the path or the text describing the path length so that it would look like this  . Right-click and select the **Rebuild the entire ruler** option on the context menu.

There are several ways to delete a measurement:

1. To delete an incomplete measurement, press **Esc**.
2. To delete a measurement path, hover the cursor over the path, a point, or the text describing the path length so that it would look like this  . Press the **Delete** key on the keyboard or right-click and select the **Remove surface ruler** option on the context menu.
3. To delete all measurements, click the **Delete all Measurements**  button on the toolbar. In the dialog box that appears, Click **YES** to delete or **NO** to cancel. If you want the DICOM Viewer to always delete annotations and measurements without this confirmation, check the box **Don't show this dialog again** and click **YES**. If you want the DICOM Viewer to show the confirmation dialog, check the box **Ask before deleting all annotations and measurements** (see Section 16.7.1).

The **Surface ruler** tool is also available from the model context menu and from the **Volume** main menu item. Activation is only possible with the left mouse button.

### 3.11.4 3D Angle

To measure an angle on the model:

1. Activate the **3D Angle**  tool by clicking the left/right/middle mouse button. To continue work with this tool, use the button with which the tool was activated. To learn more about tool control, see Section 1.14.
2. Make two points on the model clicking the mouse button. The second point is the angle apex.
3. Move the cursor over the screen to set the other side of the angle.
4. Click the mouse button to fix the second side of the angle.
5. To cancel an incomplete measurement, press **Esc**.

To move the 3D angle point:

1. Locate the cursor on the point to be moved so that it would look like this  .
2. Drag the point, holding the left mouse button.

To remove the 3D angle:

1. Locate the cursor on the line of the 3D angle to be deleted so that it would look like this  .
2. Press the **Delete** key on the keyboard or right-click the mouse and select the **Remove 3D angle** command.

This tool is also available from the model context menu and from the **Volume** main menu item. Activation is only possible with the left mouse button.

### 3.11.5 Customizing the Text Size for Measuring Tools

To change the text size for a measurement that has already been displayed, right-click on the point, line or text referring to the measurement result. On the context menu that pops up, select the **Options...**

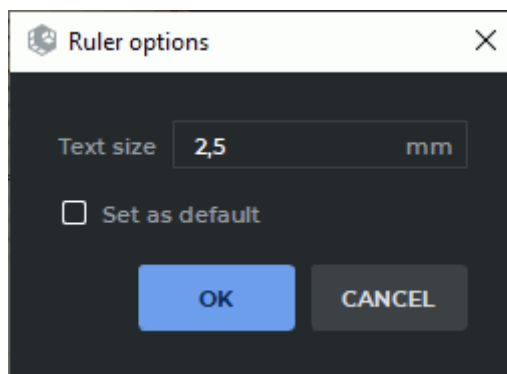

Figure 3.10: Dialog box for customizing the text size for a measuring tool

In the dialog box (Fig. 3.10), set the text size in millimeters. The minimum size is 1. If you want the new settings to be applied to all the new measurements by default, check the **Set as default** box.

Click **OK** to apply the settings or **CANCEL** to cancel.

## 3.12 Markers

Working with markers is mostly similar to the procedure described in Section 5.12. The differences are as follows:

- To drag a marker, locate the cursor on the circle in the middle of the marker. If the image scale is relatively small, the circle size may exceed the marker size.
- If the marker is on a surface currently hidden behind other tissues, only the circle in the middle of the marker will be visible, and the marker itself will be hidden. If you drag the marker, it will be moved to the model surface that is currently visible. The line marker in this situation is not visible.

## 3.13 Export Model

---

Functionality is available in the **Pro** edition

---

All the tabs may not fit in the box, in this case, scroll through the tabs, using the left and right arrows 

The export of a model to DICOM or to an image is similar to the image export described in Section 2.27.

### 3.13.1 Export Rotation to Series

To export a rotation to series:

1. Set the series description.
2. Specify the rotation axis (the default is Y).
3. Set the rotation angle (the default is 90 degrees).
4. Set the rotation step (the default is 5 degrees).
5. If you need to load the exported series to the server at once, check the option **Upload exported series to the default server**. If the default server is not specified in the DICOM Viewer this option will be inactive.
6. Specify the image size if necessary.
7. To export the rotation, click **OK**. To cancel, click **CANCEL**.

### 3.13.2 Export Rotation to Images

To export a rotation to images:

1. Set the path to the folder for export.
2. Enter the file name.
3. Select the file extension from the drop-down menu. Other parameters are described in the previous section.
4. To export the rotation, click **OK**. To cancel, click **CANCEL**.

This tool is also available from the **Volume** main menu item.

## 3.14 Render settings

The **Render settings**  tool allows for setting the rendering quality of the 3D model and the opacity threshold. The tool is available on the toolbar of the **Volume reconstruction** tab, **MPR reconstruction** tab, **Vessel analysis** tab, **Coronary artery analysis** tab and in the **Volume** section of the main menu. The tool allows you to set the quality of the model both in dynamic and static state.

The opacity threshold allows to ignore relatively transparent tissue when performing measurements and creating segments. That is, the tissue whose transparency level is below a predetermined value will be visible, but the points of the measuring tools will be projected on the tissue with a higher level of transparency. Such tissue will not be included in the segment.

To set quality:

1. Click on the **Render settings**  button on the toolbar. The dialog shown in Fig. 3.11 will be displayed.
2. Move the sliders to set the quality of the model in dynamic state (**Dynamic quality**) and in static state (**Static quality**). Move the slider to the right for maximum quality.
3. Provide the opacity threshold value for measuring tools as percentage (the **Point projection** parameter). The ability to change the threshold value makes it easier to work with linear and angular measurement tools, markers and **Select model point** tool (Section 3.5).

The tools for editing the volume (**Cut object**, **Cut all except object** and **Brush cut**) delete the tissues whose opacity is below the threshold value. For details on volume editing tool management, see Section 3.8.

4. Provide the opacity threshold value in the **Segmentation** field. The value provided in this field affects the voxel opacity level in the **Segmentation** mode.
5. Click the **CLOSE** button.

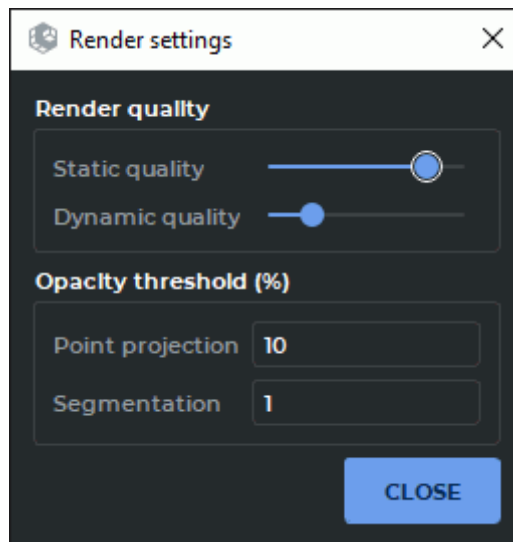

Figure 3.11: Render settings dialog box

If the quality is high, the update image may be delayed because of low computer resources.

## 3.15 Reconstruction by Series with Varying Distances between Slices

If a series contains images made with a varying step, volume reconstruction by the standard algorithm is impossible. There are two solutions to this problem.

1. The missing images are interpolated (recreated). In this case, the reconstruction will not be accurate. The DICOM Viewer will return a warning like **Series slice distance varies too much: most unique distance: 7.5 mm; min distance: 7.5 mm; max distance: 22.5 mm. Model may be inaccurate.**
2. The reconstruction is made within the part of the series where the distances between slices are the same. In this case the reconstruction will be incomplete. The DICOM Viewer will return a warning like **Series slice distance varies too much. Only slices 1-22 of 28 are used.**

The first method is used by default. For details on how to specify the preferable reconstruction method, see Section [16.7.3](#).

## 3.16 Subtraction of Volumes for Fused Series

Functionality is available in the **Pro** edition



**This function cannot be used for establishing a diagnosis**

The DICOM Viewer provides an opportunity to subtract the volume of one layer from the volume of another layer in a fused series. The result of subtraction is exported in the current study as a new series.

This function allows the user to perform subtraction for series with arbitrary relative position of slices, with or without contrast.

Fig. 3.12 shows the results of subtracting a series with contrast from a series without contrast for the same body part.

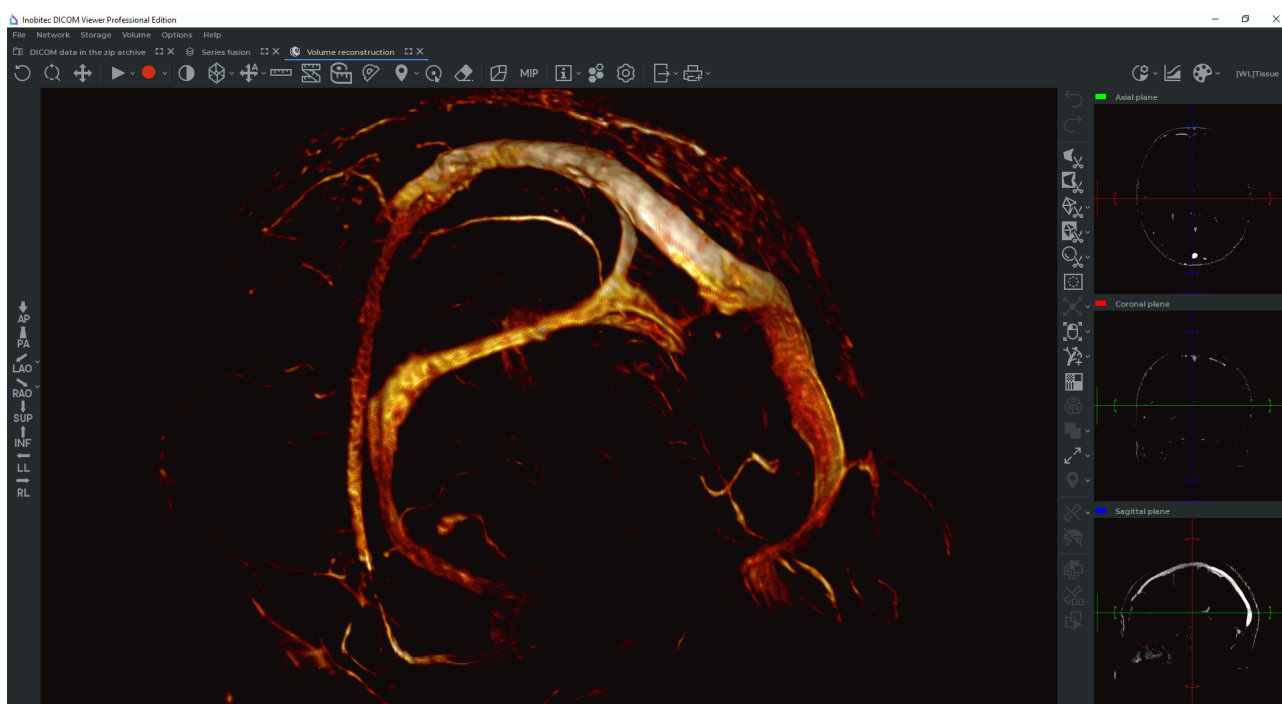

*Figure 3.12: Volume subtraction for a fused series has been performed*



**Some tissues may be deleted by mistake. This function should only be used as an auxiliary. The diagnosis should be established on the basis of the original images.**

To subtract the volume of one layer from the volume of another layer in a fused series, proceed as follows:

1. Open a fused series in the **MPR reconstruction** or **Volume reconstruction** tab. For this purpose, in the **Series fusion** tab, click the  or  button on the toolbar or select the respective command in the **View** section of the main menu.



2. On the segmentation panel, select the layer from which you want to subtract the volume. If the fused series comprises series for the same body part with and without contrast, select a layer with contrast as a layer from which the volume is to be subtracted.
3. Click the **Subtract volumes**  button on the toolbar with editing tools.
4. In the dialog box that pops up (Fig. 3.13), add the description of the created series. By default, the description is generated automatically on the basis of the following template: *<Name of the first layer>(subtracted)*. Check the information on the initial layer and select the layer to be subtracted.

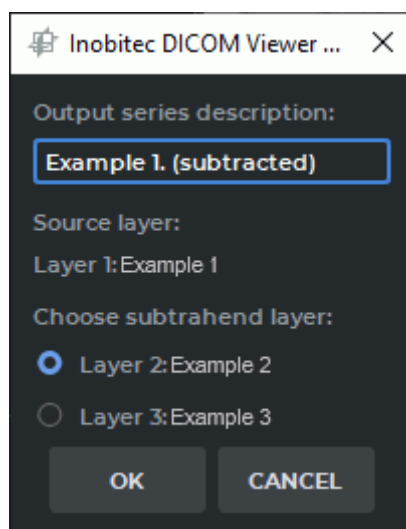





Figure 3.13: Creating a fused series for volume subtraction

5. Click **OK** to perform subtraction and export the new series to the current study or **CANCEL** to cancel. The subtraction and export procedure may take some time.  
The exported series is saved in the local storage as a new series. A thumbnail for the new series will be added to the series panel.
6. Go to the **Local storage** tab. In the current study, open the new series in the **Volume reconstruction** or **MPR reconstruction** tab. For this purpose, click the  or  button on the toolbar or select the respective command in the **View** section of the main menu.
7. If required, change the current CLUT on the rendering setup panel (see Section 2.22) and edit the image by deleting unwanted fragments with editing tools.



## 3.17 Remove Bone Tissue

### 3.17.1 Remove Bone Tissue Manually (Interactive)

Interactive bone tissue removal is performed by watershed method. To enable the interactive mode, click on the arrow on the right side of the **Remove Bones**  button on the toolbar

and check the **Interactive** box.

To remove bone tissue:

1. Open the series containing bone tissue in the volume reconstruction window.
2. Activate the **Remove bones**  tool by clicking the left/right/middle mouse button. To continue work with this tool, use the button with which the tool was activated. To learn more about tool control, see Section 1.14. The tool initiation process may take some time.
3. Set markers on the tissue that should not be deleted. To do that, click the mouse button with which the tool was activated on the tissue while holding the **Ctrl** button.
4. To delete bone and other tissue, click the mouse button with which the tool was activated on this tissue. The deletion process may take time.
5. To undo this action, click the **Undo**  button; to redo the action, click the **Redo**  button.

To set the tool parameters, click the arrow on the right-hand side of the **Remove bones**  button and select **Options....**

### 3.17.2 Removing Bone Tissue Manually (Automatic)

You can remove the bone tissue for any series specifying the required parameters manually. To do that, you need to disable the interactive mode of the tool. Click the arrow on the right side of the **Remove bones**  button on the toolbar and uncheck the **Interactive** box.

To remove bone tissue manually:

1. Open the series containing bone tissue in the volume reconstruction window.
2. Click the **Remove bones**  button on the toolbar. A dialog box (Fig. 3.14) will pop up.

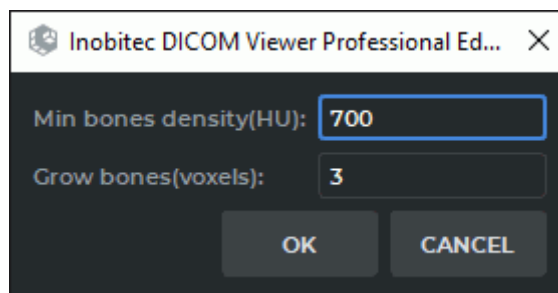



Figure 3.14: Configure bone remove parameters dialog box

3. Set the **Min bones density(HU)** value in the dialog box. All tissues whose density exceeds this value will be deleted. If you set the minimum bone density value equal to the surface layer density, some tissues other than bones may be removed as well.

4. Set the **Grow bones (voxels)** value. This value allows you to set the thickness of the soft bone surface layer in voxels.
5. Click the **OK** button to remove bones or **CANCEL** to cancel.
6. As a result of the operation, bone tissues are removed. Other tissues adjacent to bone tissue, such as vessels, are not deleted.

All these values should be adjusted experimentally. The default values are not optimum.

To remove bone tissues with a lesser density, click the **Remove bones**  button and reduce the minimum bone density value. If the value turns out to be too small, undo the last removal using the **Undo**  button, and increase the minimum bone density value during the next removal.



**Some tissues that are different from bone structures may be deleted by mistake. This function should only be used as an auxiliary. The diagnosis should be established on the basis of the original images.**



This tool is also available from the **Volume** main menu item.

### 3.17.3 Remove Bone Tissue for Fused Series

Functionality is available in the **Pro** edition

This tool is used for angiographic and other studies containing at least one series with contrast and one series without it for the same body area.

To remove the bone tissue:

1. Fuse the series with contrast and without it in the **Series fusion** tab (see Chapter 4). The series fusion is stored in the local storage in the same study.
2. Open the fused series in the **Volume reconstruction** or **MPR reconstruction** tab. To do this click the  or  button on the toolbar or select the corresponding command in the **View** section of the main menu.
3. In the layer list select the series with contrast. By default, the first series is selected.
4. Click the **Subtract bones (Choose layer to subtract from first)**  button on the toolbar.

In the dialog box (Fig. 3.15) that opens, enter the name of the new series. By default, the new series is named *<Name of the first layer>(Bones subtracted)*. Under the name of the new series, the names of the layers for the created series are displayed. Click **OK** to create a new series or **CANCEL** to cancel. The process may take some time. Upon completion, a series without bones will appear on the series panel for this study.

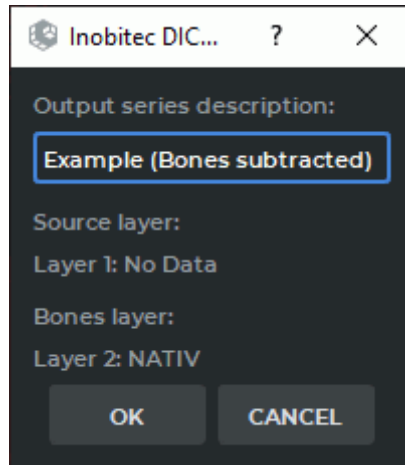



Figure 3.15: Creating a fused series for subtracting bones

5. Go to the **Local storage** tab. Open the new series in the **Volume reconstruction** or **MPR reconstruction** tab. To do this click the  or  button on the toolbar or select the corresponding command in the **View** section of the main menu.
6. Change the current CLUT to the **CT-Bones** on the visualization setup panel (see Section 2.22).

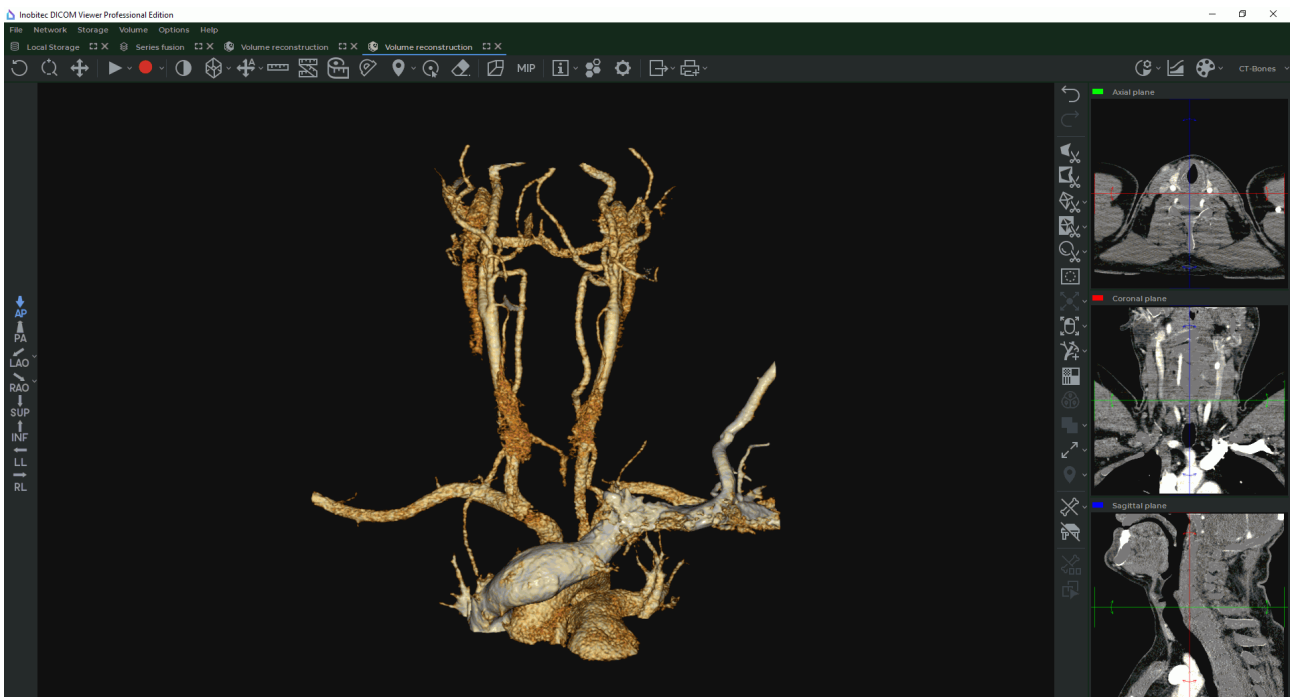

Figure 3.16: The bone tissue has been removed

If required, edit the image removing bone tissue with editing tools.



**Some tissues that are different from bone structures may be deleted by mistake. This function should only be used as an auxiliary. The diagnosis should be established on the basis of the original images.**

# Chapter 4

## Series Fusion

There are certain peculiarities associated with fused series depending on the type of the rendering device:

- On a CPU-based renderer, the display of merged series may not be accurate in the Volume reconstruction tab.
- For the CUDA renderer, no more than four fused series may be displayed in the Volume reconstruction tab.
- For OpenCL and Metal rendering devices, no more than four fused series may be displayed in the Volume reconstruction tab and no more than eight fused series may be displayed in the MPR reconstruction tab.



To be suitable for fusion, series must comply with the following requirements:

- the images in the series must be monochrome;
- there must be an opportunity to sort the images by the position and the phase;
- for multiphase series, the number of phases must be equal. Yet, it is possible to fuse a single-phase series with a multiphase series.



**The series obtained as a result of fusion cannot be fused again.**

## 4.1 Create Series Fusion

Functionality is available in the **Pro** edition

To create a series fusion:

1. Open the study.
2. Select the series.
3. Click the **Series fusion**  button on the toolbar or select the **View** menu and the **Series fusion** item.
4. In the **Available series** section of the **Series fusion** tab (Fig. 4.1), choose the series you want to fuse with the selected series.

In the **Available series** section, you can see the thumbnails for the series available for fusion. Each thumbnail provides the following information: the icon for the data source (in the left-hand top corner), the number of images (in the right-hand top corner), and the series modality (in the right-hand bottom corner).

5. To add a selected series, click the **Add series as a new fusion layer**  or select the **Fusion** menu and the **Add new layer** item. The added series is displayed on the panel **Layers list** (Fig. 4.1).

On the **Layers list** panel, you can see thumbnails for the series that have been fused. Each thumbnail provides the following information: the icon for the data source (in the left-hand top corner), the number of images (in the right-hand top corner), and the series modality (in the right-hand bottom corner).

If the fused series has already been opened in the **MPR reconstruction** or **Volume reconstruction** tab, a new layer will also be added to the series in such a tab.

6. To delete a slice from the **Layers list** panel select it and click the **Remove fusion layer**  button or select the **Fusion** menu and the **Remove layer** item. If the series fusion is already open in the **MPR reconstruction** or **Volume reconstruction** tab, then the series will also be removed in these windows.



**The first (base) layer on the Layers list panel cannot be deleted.**

7. If necessary, open the series fusion in the **Volume reconstruction**, **MPR reconstruction** or **Virtual endoscopy** tab by clicking the corresponding button on the toolbar.

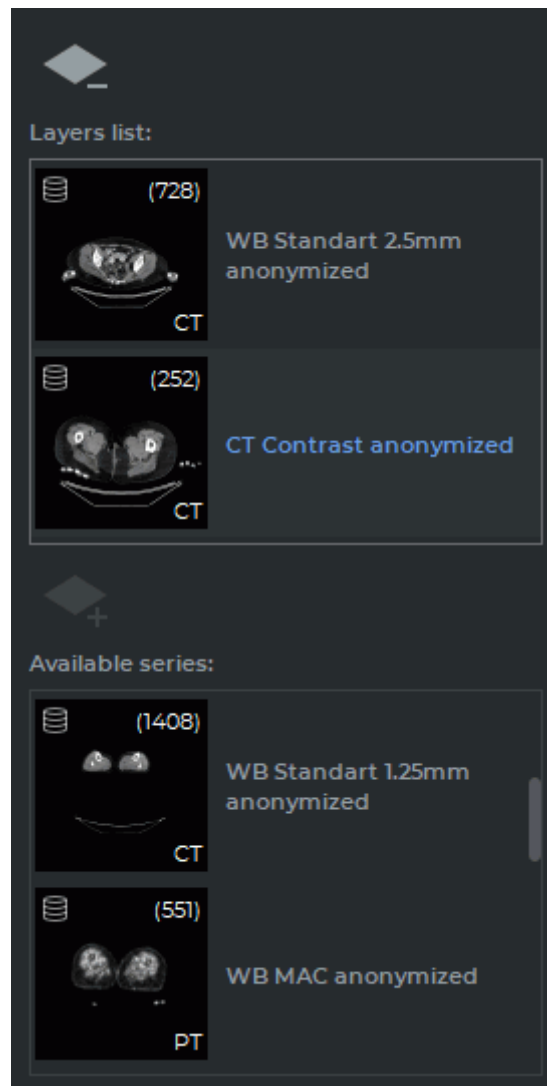

Figure 4.1: The layers list and the available series list

The series fusion will appear on the current study series panel and may as well be opened from there.

This tool is also available from the image context menu.

## 4.2 Merge Series from Different Studies

---



Functionality is available in the **Pro** edition

---

To merge series from different studies:

1. Select the first study from the study panel.
2. Select one of the series from this study.



3. Click the **Series fusion**  button on the toolbar or select the **View** menu and the **Fusion** item.
4. In the **Series fusion** tab, on the **Layers list** panel, you can see the selected series. The **Layers list** panel shows the series that have been fused.
5. Switch to the previous tab.
6. Select another study from the study panel.
7. Select the series to be merged with the selected series from the first study.
8. Drag the series to the **Series fusion** tab. The second series will be added to the Layers list (Fig. 4.1).
9. To delete a slice from the **Layers list** panel select it and click the **Remove fusion layer**  button or select the **Fusion** menu and the **Remove layer** item.



**The first (base) layer on the Layers list panel cannot be deleted.**

10. Set the visualization mode for the second slice (see Section 2.22.1).

The order of selecting series is important. The first (basic) series of images is located behind the second series in the flat image view window. The volume model is based on the first series, and even if the second series covers a larger volume of tissue, only those images are used in the reconstruction, the location of which is the same in both series, and the others are ignored.

Merged series can be opened in the Volume Reconstruction, Multiplanar Reconstruction and Virtual Endoscopy windows.

## 4.3 Merge layers



---

Functionality is available in the **Pro** edition

---

Fused layers do not always coincide, particularly in cases when two different studies are fused (Fig. 4.2). In this case, you need to merge layers.

To merge layers:

1. Open the fused series in the Multiplanar Reconstruction window by clicking the **MPR reconstruction**  button on the toolbar.
2. In the Multiplanar Reconstruction tab, open the segmentation panel by clicking the **Segmented structure panel**  button. There is the **Fusion of layers** panel at the bottom of the **Segmentation** panel (Fig. 4.3).

3. Select the layer which must be merged with the base one. If the selected layer has the same «FrameOfReferenceUID» tag value as any other layer, then you will see a  button on the **Fusion of layers**. You will find more information on merging layers with a locked system of coordinates in Section 4.3.1.
4. Merge layers automatically (see Section 4.3.2), manually (see Section 4.3.3) or by points (see Section 4.3.4).

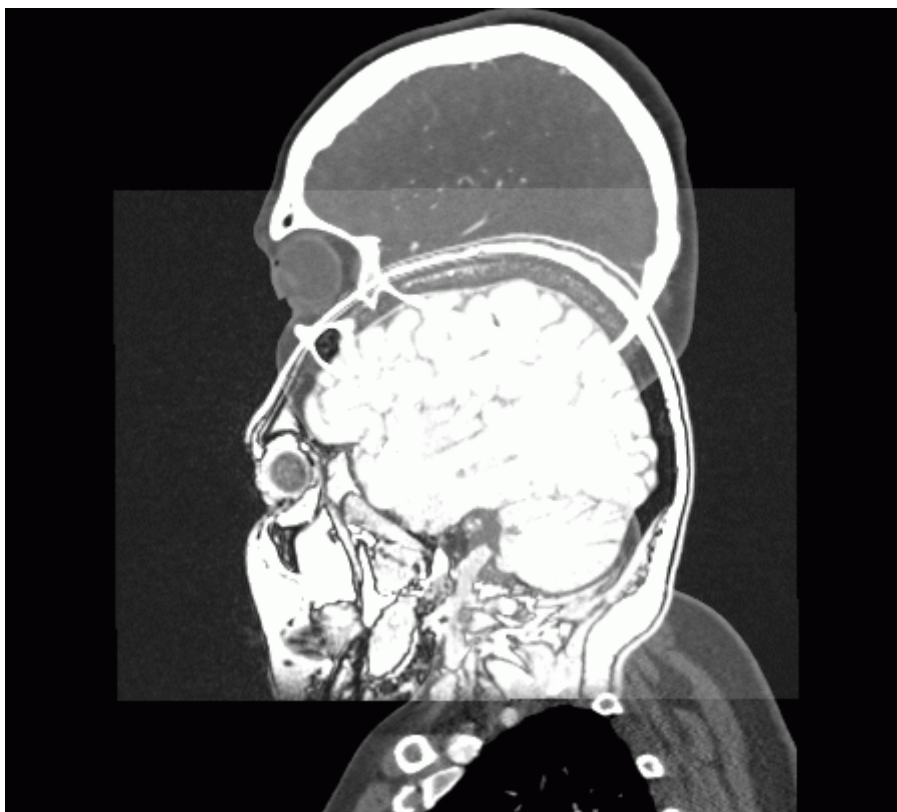

Figure 4.2: Not merged layers

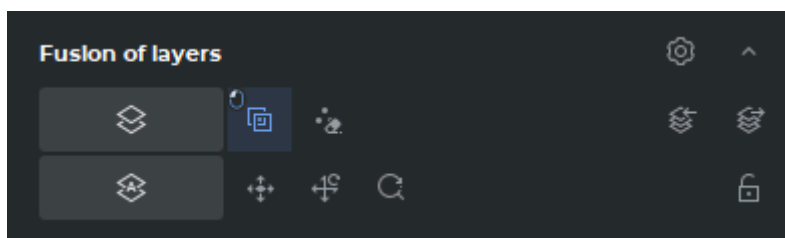





Figure 4.3: Fusion of layers panel

To reduce the **Fusion of layers** panel, click the **Hide**  button. To expand the reduced panel, click the **Show**  button.

To customize the fusion mode settings, click the **Options**  button on the **Fusion of layers** panel. The respective dialog box is shown in Fig. 4.4.

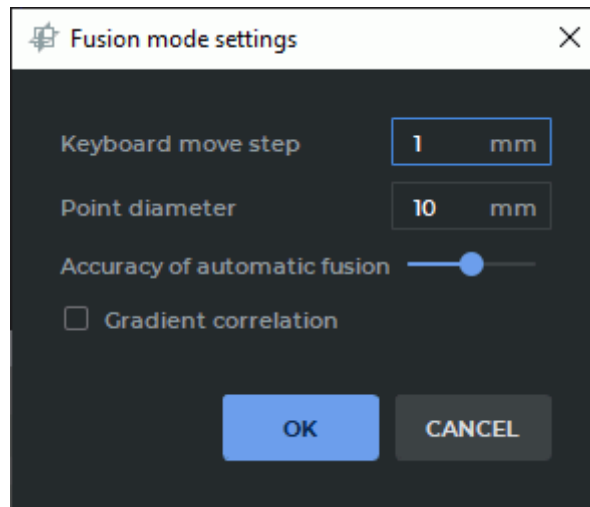



Figure 4.4: Layer fusion mode settings dialog

### 4.3.1 Locking the Frame of Reference for a Layer



Functionality is available in the **Pro** edition

The position of series of the same study is normally specified in the same frame of reference. The identifier of the frame of reference is provided in the «FrameOfReferenceUID» DICOM tag. Series with the same «FrameOfReferenceUID» tag value have the same frame of reference.

If the selected layer has the same frame of reference as any other layer, you will see the  button on the fusion of layers panel. This button is not shown for the first (basic) layer.



When layers are fused, layers with a locked frame of reference change their position simultaneously with the other layers that have the same frame of reference. If a layer with a locked frame of reference has the same frame of reference as the basic (first) layer, it cannot be merged without unlocking.

To merge layers with a locked system of coordinates, proceed as follows:

1. Select the layer whose coordinate system you want to unlock for merging. You will see a  button on the Fusion of layers panel.
2. Click the **Unlock layer frame of reference**  button on the Fusion of layers panel. The button for a layer with unlocked coordinate system appears as  .
3. Merge layers automatically (see Section 4.3.2), manually (see Section 4.3.3) or by points (see Section 4.3.4).

4. If needed, unlock the coordinate system of the other layers and merge again.

The frame of reference is locked and unlocked for each layer separately. Layers with an unlocked frame of reference can be moved independently. When you customize the position of layers with a locked frame of reference, it has no impact on the layers with an unlocked frame of reference.

To restore the original frame of reference for a layer, click the **Lock layer frame of reference**  button on the fusion of layers panel. After unlocking, the layer restores the position it had before the **Lock layer frame of reference**  button was pressed.

The settings concerning the position of layers and the information on locking are saved in the segmentation project (see Section 6.11.1) and when matrices are exported to DICOM (see Section 4.3.5).

### 4.3.2 Merge layers automatically

---

Functionality is available in the **Pro** edition

---

To merge layers automatically:

1. Click the **Merge layers automatically**  button on the **Fusion of layers** panel (Fig. 4.3). This starts the merging process, the **Optimizing correlation** dialog will open.
2. To cancel the merging process, click the **CANCEL** button in the **Optimizing correlation** dialog.
3. When the merging process is completed, click the **DONE** button.
4. Merging quality can be poor if the tissue density on the merged layers is very different. In this case, check the **Gradient correlation** box on the **Fusion mode settings** dialog (see Section 4.3, Fig. 4.4) and repeat steps 1-3.
5. To change the merge accuracy, move the **Accuracy of automatic fusion** slider on the **Fusion mode settings** dialog (see Section 4.3, Fig. 4.4). Move the slider to the right for maximum quality. High accuracy requires more time to merge.







To merge layers by part of their volume:

1. Choose a layer you need to merge with the base layer.
2. Create a segmented structure for this layer. The mask of the structure should conform to the volume to be merged. The merge is performed by mask rather than by the created segmented structure volume.
3. Click the **Merge layers automatically**  button.

### 4.3.3 Merge layers manually

Functionality is available in the **Pro** edition

To merge layers manually:



1. Activate the **Manual layer fusion**  tool by clicking the left/right/middle mouse button. To continue work with this tool, use the button with which the tool was activated. To learn more about tool control, see Section 1.14.
2. Match the images in three projections. To do this:
  - drag the selected slice, holding the left mouse button or pressing the cursor management keys , ,  and ;
  - rotate the selected slice, holding the **Alt** key and the left mouse button;
  - zoom the selected slice in and out, holding the **Ctrl** key and the left mouse button.
3. To cancel all transformations, click the **Reset layer transformations**  button.
4. To cancel zoom, click the **Reset layer zoom**  button.
5. To set the displacement step, set the desired value in the **Keyboard move step** field of the **Fusion mode settings** dialog box (see Section 4.3, Fig. 4.4).
6. When the slices are matched satisfactorily, close the **MPR reconstruction** tab. The **Series fusion** tab will reappear on the screen.
7. Browse the series fusion images to see the result. If the result is unsatisfactory, repeat the merging process.

### 4.3.4 Merge layers by control points

Functionality is available in the **Pro** edition

To merge layers by control points:

1. Make all the layers transparent except the base one. To do this, move the transparency slider for the MPR windows of the corresponding layer to the left. The transparency slider is highlighted in red in Fig. 4.5.
2. Select the base layer on the segmentation panel.
3. Activate the **Mark the points**  tool by clicking the left/right/middle mouse button. To continue work with this tool, use the button with which the tool was activated. To learn more about tool control, see Section 1.14.

4. Put at least three control points on the image. Each point has its own colour and number.
5. Select the layer that you want to fit with the base. Make all the layers transparent except this one.
6. Put on this layer the same number of control points in the same places as on the base layer. Point numbering starts over again. The colours of the corresponding points are the same.
7. If necessary, adjust the position of points on all three orthogonal planes. When you locate the cursor on a point, it is highlighted on all three orthogonal planes.
8. To delete point, locate the cursor on it, right-click the mouse and select the **Remove point** item.
9. To switch to slices containing a point, move the cursor to this point, right-click the mouse and select the **Go to point** item. The point on the current slice is brighter than others.
10. To delete all points, click on the **Remove all points**  button on the **Fusion of layers** panel. In the dialog box that opens, click **YES** to confirm the deletion, or click **NO** to cancel.
11. To change the point diameter, open the **Fusion mode settings** dialog (see Section 4.3, Fig. 4.4). Set the diameter of the points.
12. Click on the **Fit layers by points**  button on the **Fusion of layers** panel. The second layer will be moved in such a way that the corresponding points are as close to each other as possible.
13. If necessary, adjust the position of the points and repeat the previous step again.
14. If necessary, add the same number of points on all the layers.

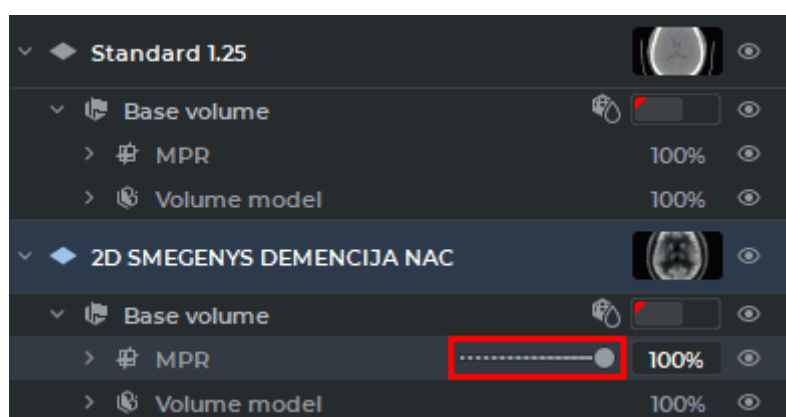

Figure 4.5: Control layer slider

Fig. 4.6 illustrates the example of control points location. Red dots (#1) are located on the tip of the nose, green (#2) on top, blue (#3) on the right eye.

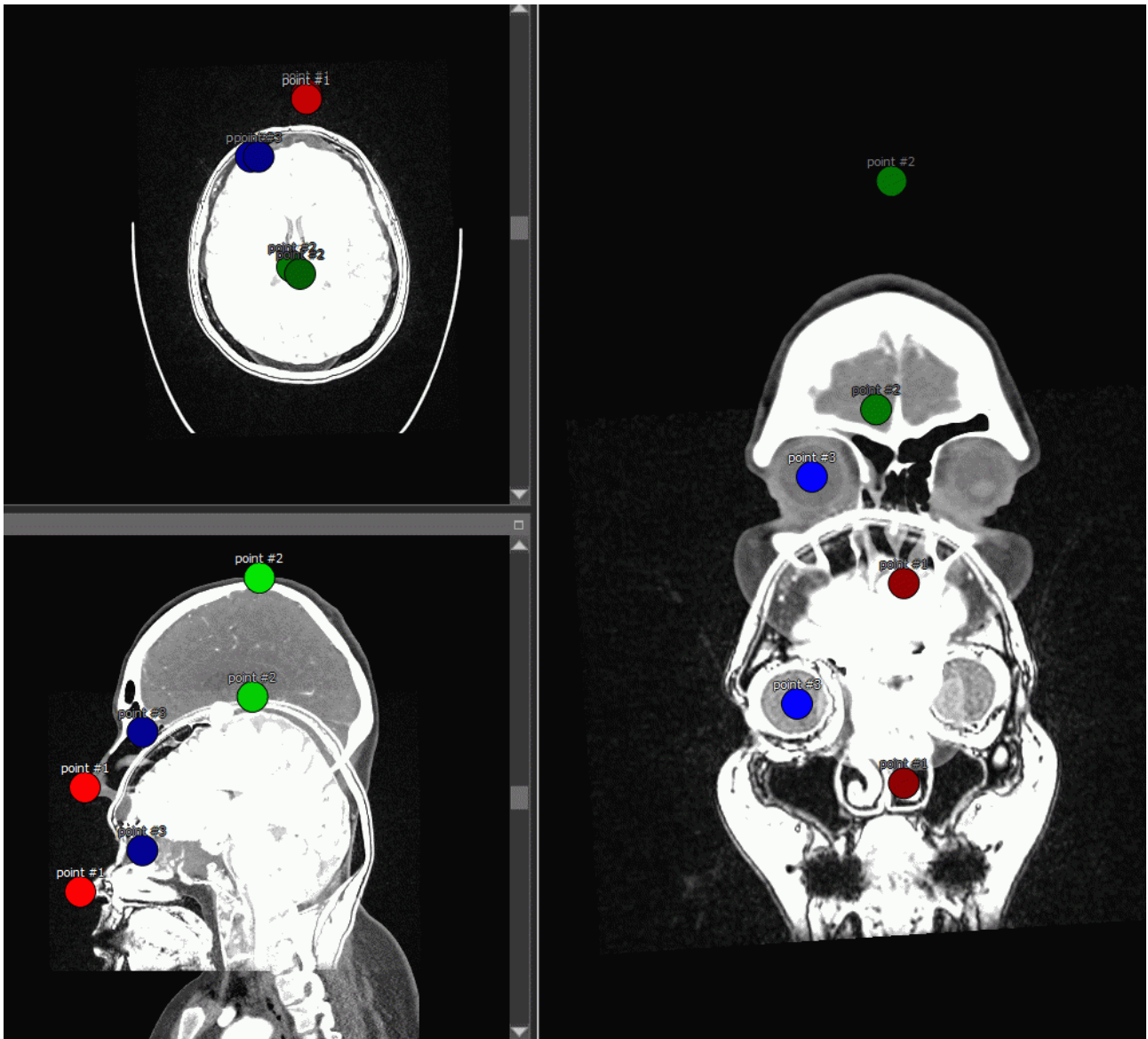

Figure 4.6: Control points

If the points are set correctly, they match with little margin of error. If the points are set inaccurately, the result looks something like in Fig. 4.7.

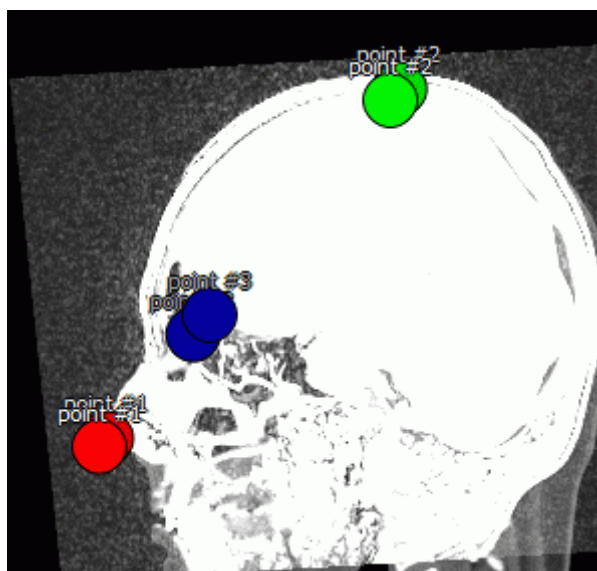



Figure 4.7: Control points are matched with a large margin of error due to location errors

### 4.3.5 Export and Import Matrices of Merge Layers

Functionality is available in a separate module which is activated in the Pro edition for an extra fee

The DICOM Viewer exports and imports matrices of merge of layers into DICOM Spatial Registration IOD (modality REG).

To export merge of series, click the **Export series registration to DICOM object**  button on the **Fusion of layers** panel (Fig. 4.3).

In the dialog box **Export to DICOM Registration** (Fig. 4.8) add the description of the exported merged series. By default, the series description is «Registration». Click **OK** button to export series or **CANCEL** to cancel.

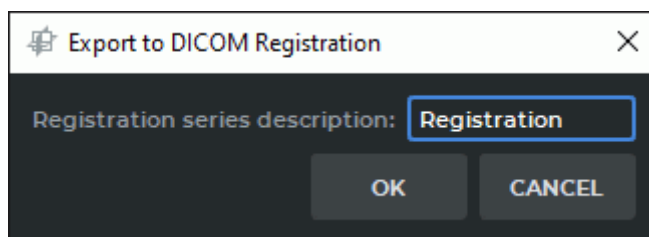



Figure 4.8: The dialog box «Export to DICOM Registration»

The exported merged series will be saved in the local storage as a new series with REG modality. A thumbnail for the new series will be added to the series panel in the study containing the base layer.



To import a matrix merged layers:

1. Make a series fusion from the series for which the object was exported **DICOM Registration**. Pay attention to the order of the series selection. Select the first (base) layer.
2. Click the **Import series registration from DICOM object**  button on the **Fusion of layers** panel (Fig. 4.3).
3. In the dialog box **Import from DICOM Registration** (Fig. 4.9) select a REG modality series to import. Click **OK** button to import series or **CANCEL** to cancel.

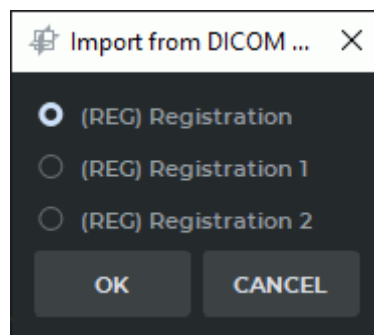

Figure 4.9: The dialog box «Import from DICOM Registration»

The layers are merged relative to the first (base) layer.

## 4.4 Image registration

Functionality is available in the **Pro** edition



### This function cannot be used for establishing a diagnosis

This tool allows you to deform the images so that their coincidence is maximal. If the inconsistencies of the series are too large (for example, the patient turned), you must first merge the layers manually or automatically (see Section 4.3) and then register the images.

Images can be registered for:

- series with the same modality;
- phases of one series.

If a study contains images with a varying density over time (for example, due to the introduction of contrast), then registration may not be performed correctly. To do this, exclude the tissue with varying density.

- Set the maximum value of the density for which registration is performed. In this case, the tissues with a density higher than the specified value do not participate in the registration, and their deformation is performed according to another algorithm.
- Check the **Use image gradient** in the Series registration settings dialog. This mode requires a large amount of video card memory. If the registration failed due to a lack of video card memory of the video card, turn off this mode or select a CPU(software) render device (see Section 16.7.3).

If the images contain air outside the patient's body, then the density of such areas for CT examinations is usually less than or equal to -1024. It makes no sense to register these sections of images. Hence, for CT studies, the default minimum density value is -1023.

If the registration failed due to a lack of video card memory, select a CPU(Software) render device (see Section 16.7.3). In this case, the registration takes more time, but it is performed regardless of the amount of GPU memory.



### 4.4.1 Series registration

---

Functionality is available in the **Pro** edition

---

To register two series:

1. Create a fused series of at least two series.
2. Open the fused series in the Multiplanar Reconstruction window.
3. If the inconsistencies between the series are too large (for example, the patient turned over), you must first merge the layers manually or automatically (see Section 4.3). More accurate merging of layers enables faster registration.
4. Open the segmentation panel by clicking the **Segmented structure panel**  button.
5. Select a base layer on the layers panel (fixed layer). Its images will not be changed.
6. Click the **Volumes registration**  button. The dialog shown in Fig. 4.10 appears. If more than two series are fused, then the list from which you must select one series for registration (**Choose moving series layer**).

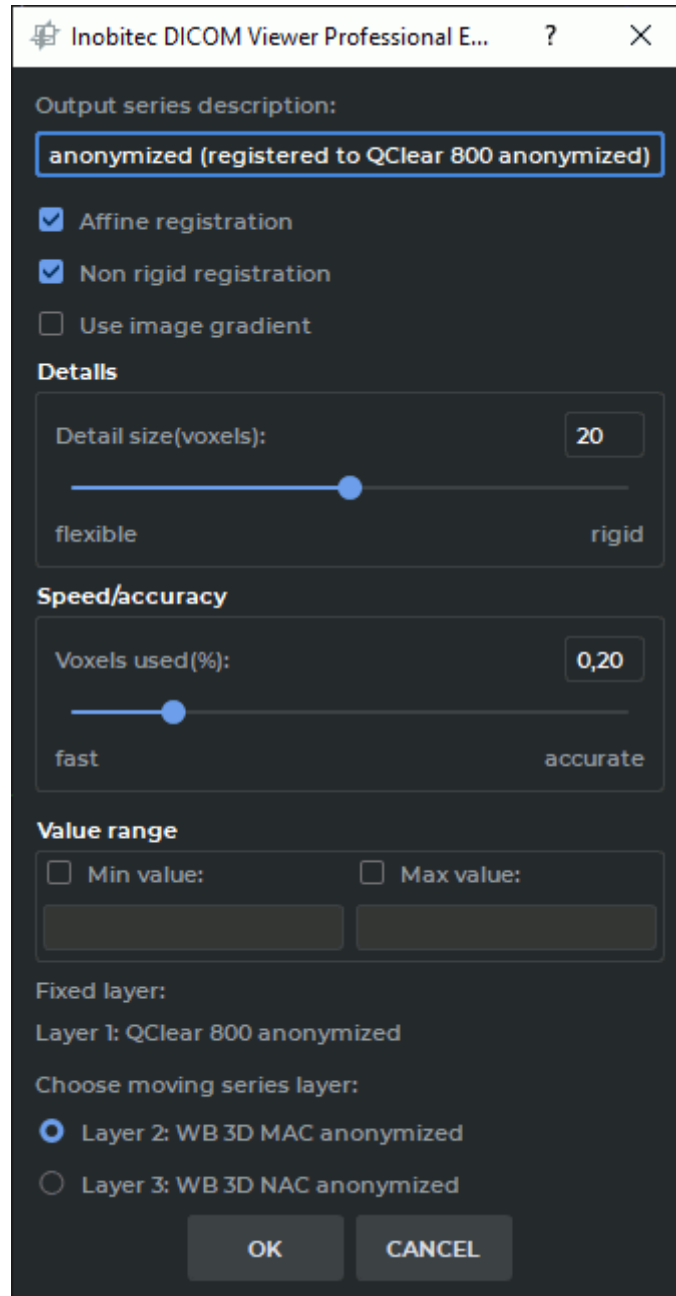

Figure 4.10: Series registration settings dialog

7. The **Output series description** field will be automatically filled in based on the name of the series being registered, and it will contain the «**registered**» mark. If necessary, change the description.
8. Select the desired registration options, checking the **Affine registration**, **Non rigid registration** and **Use image gradient** boxes.
9. Set the minimum size of the parts that will affect registration. The default size is 20 voxels. The smaller the value is, the more minor details are registered, but the risk of incorrect registration increases.

10. Set the percentage of voxels that are used during the registration. The larger the value is, the higher the accuracy is, but the lower the registration rate gets.
11. If it is necessary to perform registration for a specific range of densities, then set the minimum and/or maximum values. To do this, set the appropriate flag and enter a numeric value. If the flag is set, but the value is not set, then the **OK** button is unavailable. For CT series, the minimum default value is -1023.
12. Click **OK** to export the series or **CANCEL** to cancel. Registration may take a long time depending on the amount of RAM and the speed of the computer.



## 4.4.2 Phases registration

---

Functionality is available in the **Pro** edition

---

To register the [phases](#) of one series:

1. Open the [multiphase](#) series in the Multiplanar or Volume Reconstruction window.
2. Open the segmentation panel by clicking the **Segmented structure panel**  button.
3. Click the **Volumes registration**  button. The dialog shown in Fig. 4.11 appears.
4. The **Output series description** field will be automatically filled in based on the name of the series being registered, and it will contain the «**registered**» mark. If necessary, change the description.
5. Select the base phase that should not be changed (fixed phase).
6. Select the desired registration options, checking the **Affine registration**, **Non rigid registration** and **Use image gradient** boxes.
7. Set the minimum size of the parts that will affect registration. The default size is 20 voxels. The smaller the value the more minor details are registered, but the risk of incorrect registration increases.
8. Set the percentage of voxels that are used during the registration. The larger the value is, the higher the accuracy is, but the lower the registration rate gets.
9. If it is necessary to perform registration for a specific range of densities, then set the minimum and/or maximum values. To do this, set the appropriate flag and enter a numeric value. If the flag is set, but the value is not set, then the **OK** button is unavailable. For CT series, the minimum default value is -1023.
10. Click **OK** to export the series or **CANCEL** to cancel. Registration may take a long time depending on the amount of RAM and the speed of the computer.

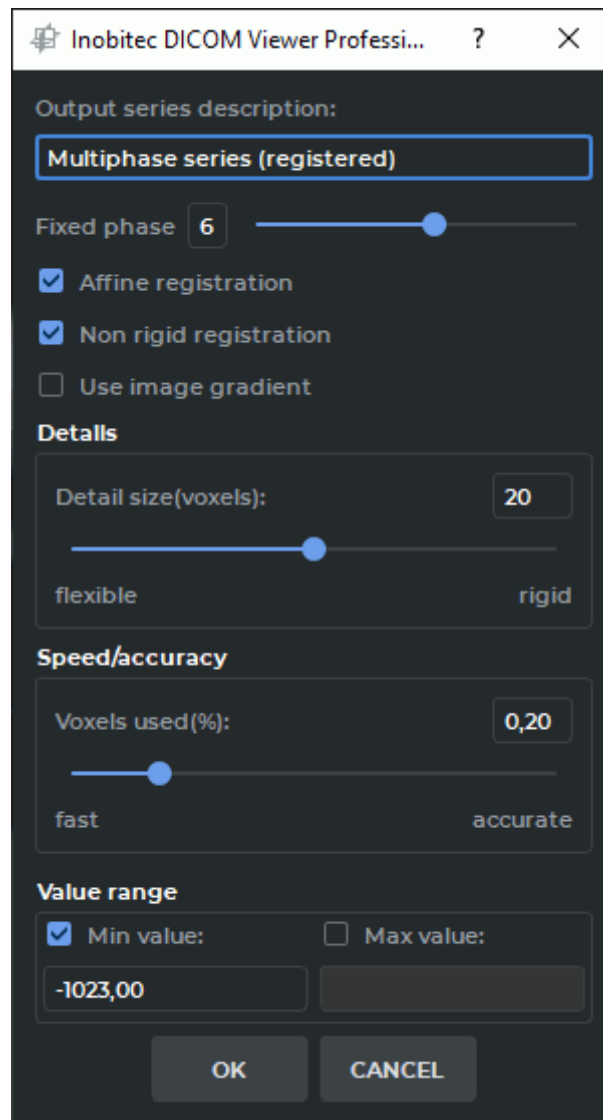















Figure 4.11: Phases registration settings dialog

## 4.5 Actions with the fused series

Functionality is available in the **Pro** edition

Action buttons on the toolbar:

	The <b>Rotate</b> tool is described in Section <a href="#">2.16</a>
	The <b>Zoom</b> tool is described in Section <a href="#">2.16</a>
	The <b>Pan</b> tool is described in Section <a href="#">2.16</a>
	The <b>Adjust W/L</b> tool is described in Section <a href="#">2.17</a>
	The <b>Ruler</b> tool is described in Section <a href="#">2.19</a>
	The <b>Angle</b> tool is described in Section <a href="#">2.19</a>
	The <b>Cobb angle</b> tool is described in Section <a href="#">2.19</a>
	The <b>Point value</b> tool is described in Section <a href="#">2.19</a>
	The <b>ROI rectangle</b> tool is described in Section <a href="#">2.19</a>
	The <b>ROI ellipse</b> tool is described in Section <a href="#">2.19</a>
	The <b>ROI polygon</b> tool is described in Section <a href="#">2.19</a>
	The <b>Delete all annotations and measurements</b> tool is described in Section <a href="#">2.19</a>
	The <b>Quick export images</b> tool is described in Section <a href="#">2.27</a>
	The <b>Add to print list</b> tool is described in Section <a href="#">19</a>

## 4.6 Image stitching mode

Functionality is available in the **Pro** edition

If a the study contains several series that are the results of scanning sections of an extended area, then such series can be fused into one in the «stitching» mode. The mutual arrangement of images from different series is determined automatically according to the scanner data.

To «stitch» images:

1. Open the study containing the series that need to be «stitched» in the series fusion window.
2. Make a series fusion. If the image does not fit in the window, use the image positioning tools **Zoom** and **Pan** (see Section 4.5).
3. Click the  **Image stitching mode** button on the toolbar. The image will change as shown in Fig. 4.12 (the right-hand image is the image after «stitching»).

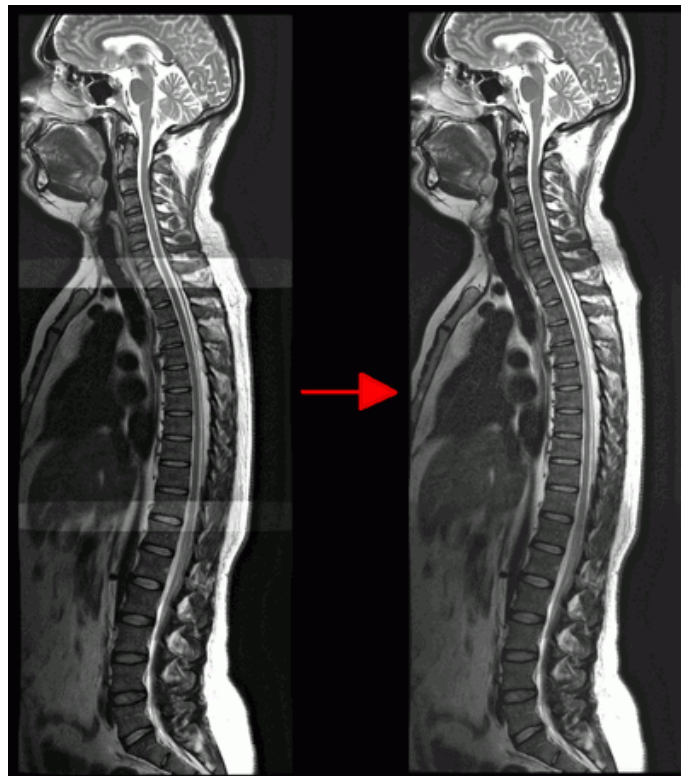

Figure 4.12: Changes in the «stitching» mode (the right-hand image is the image after stitching)

In the «stitching» mode, the **Adjust W/L** tool applies to the entire series.

## 4.7 Volume Stitching

Functionality is available in the **Pro** edition



**This function cannot be used for establishing a diagnosis**

The DICOM Viewer provides an opportunity to export several fused series to the current study as a new series. The fused series will be stitched as one layer.

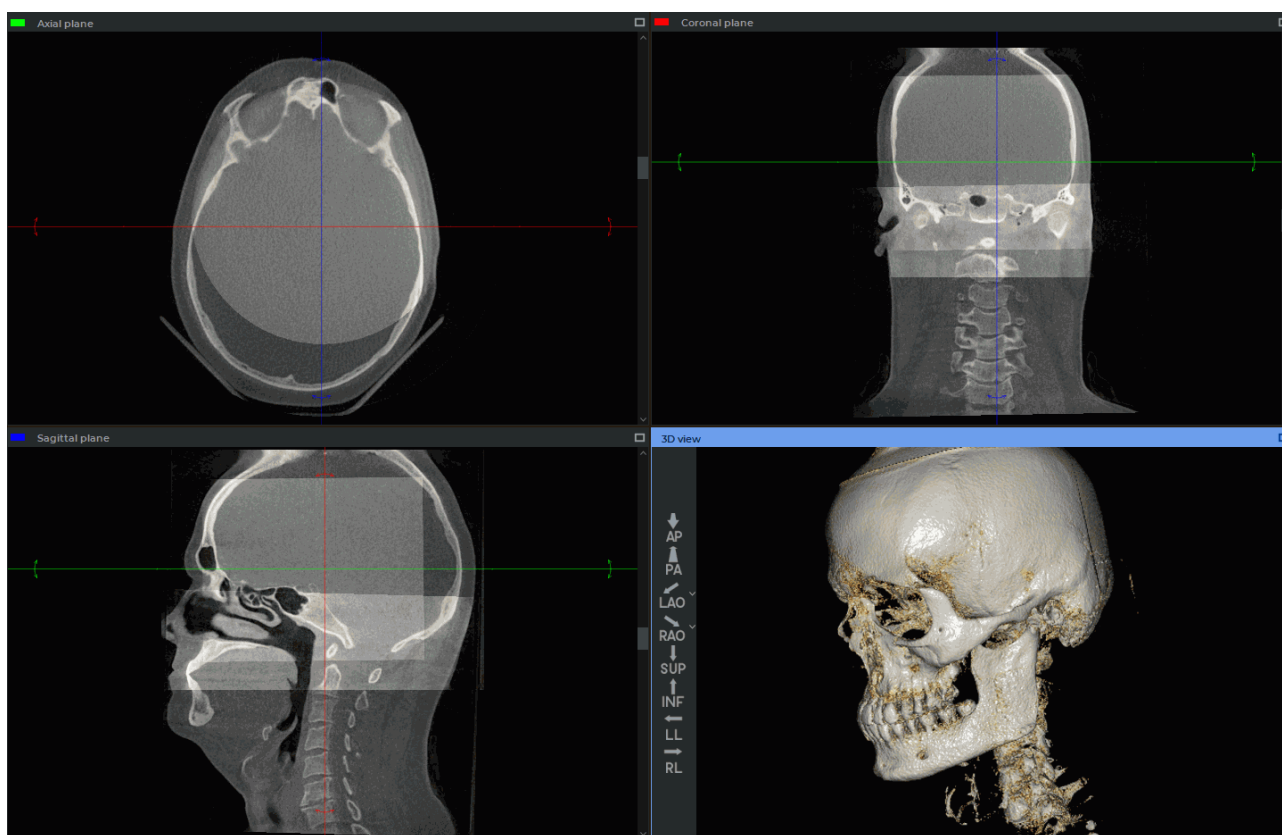

*Figure 4.13: The layers are fused, and the new series is ready for stitching*

To export a fused series to the current study as a new series, proceed as follows:

1. Open the series in the **MPR reconstruction** tab.
2. Click the **Export** button on the segmented structure panel and select the **Export volume stitching** option on the dropdown menu (Fig. 4.14).



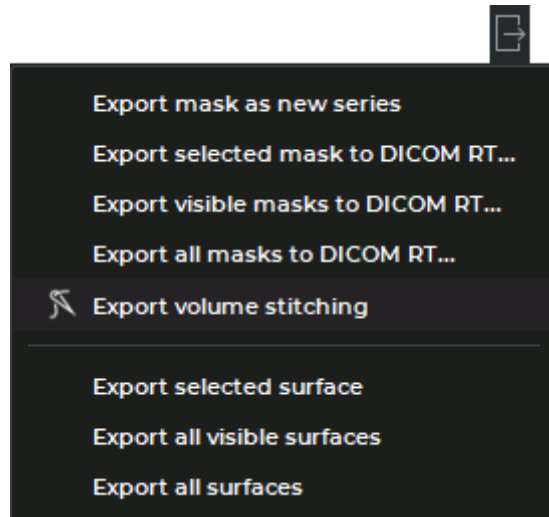

Figure 4.14: Export menu

3. In the **Volume stitching options** (Fig. 4.15) dialog box that pops up, add a description of the series created. By default, the description is generated automatically according to the following template:  
*stitching of <description of the 1st layer series> and ... <description of the N layer series>*

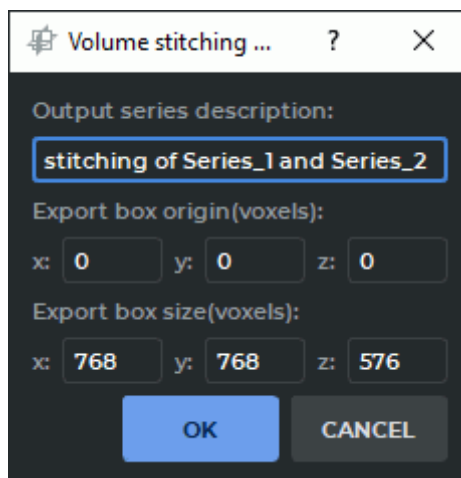

Figure 4.15: Dialog box for customizing the volume stitching parameters

4. Specify the position and the boundaries of the exported area in the coordinates of the voxel model of the first (basic) layer. The size of the exported area will be calculated automatically and may be changed by the user. The position and the boundaries of the exported area are shown in the windows of the **MPR reconstruction** tab and may be changed when editing the numeric values.

The acceptable range of values for the coordinates of the exported area position is from -8192 to 8192, for the coordinates of the boundaries — from 1 to 8192.



**The boundaries of the exported area along the X and Y axes are determined by the volume of the basic layer.**

5. Click **OK** to stitch the layers of the fused series and export the new series to the current study, or click **CANCEL** to cancel. The stitching and export procedure may take some time.



**Make sure that all the volume required has been exported.**

The exported series is saved in the local storage as a new series. A thumbnail for the new series will be added to the series panel.

If one or several original series are multiphase series, the stitching and export procedures are only performed for the current phase.

---

## Chapter 5

# Multiplanar Reconstruction (MPR)



In Multiplanar Reconstruction window, diagnosis can only be established on the basis of CT, MR, XA and MG series

### 5.1 Open Study in Multiplanar Reconstruction window

To open a study in the multiplanar reconstruction window:

1. Load the studies to the DICOM Viewer.
2. Select the target study from the study panel.
3. Click the **MPR reconstruction**  button on the toolbar. To select the tab location (in the current window, in a separate window or in the full screen mode), click on the arrow on the right side of the button. To open the multiplanar reconstruction window in a new tab in the current window, click on the button. The process may take some time.

Fig. 5.1 illustrates the multiplanar reconstruction window.

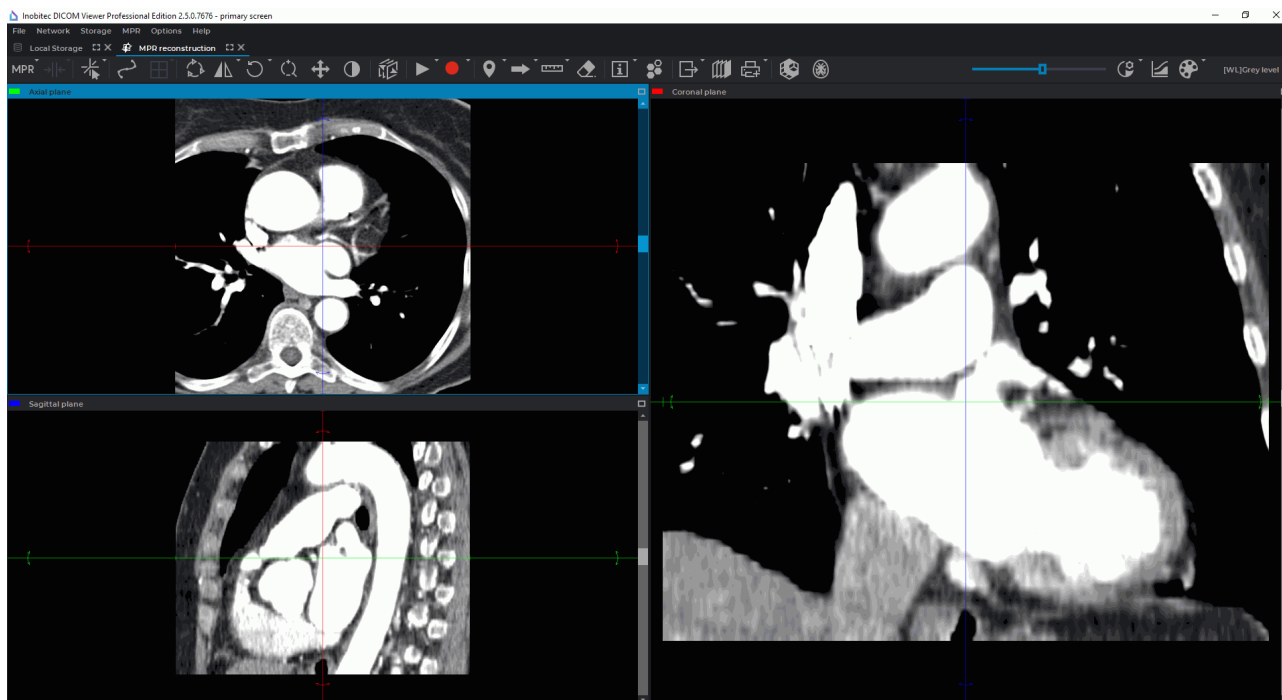

Figure 5.1: MPR reconstruction tab

## 5.2 MPR View Elements

The tab will display three image view windows. The top left window displays the axial section, the right window shows the coronal section, the bottom left window contains the sagittal section .



This template for the arrangement of section windows is activated by default. The information regarding the choice of other window arrangement templates is provided in Section 5.2.1.

You can maximize any of the sectional plane windows from the **MPR reconstruction** tab and restore its size in several ways:

- click on the  **Expand** button in the right-hand upper corner of the series window;
- double-click with the left mouse button on the title of the series window;
- if the measurement or graphical annotation tool is activated with the left button, double-click with the left mouse button inside the series window.

You can maximize and restore the size of the **3D view** window using the first or second method.

The DICOM Viewer provides the user an opportunity to swop section windows. To do that, choose the window you want to move, place the cursor on the window header, and press the left mouse button so that the cursor changes to  . While holding the left mouse button, drag the window to the spot you have chosen for it, and it will change places with the window that is currently in that spot.

The DICOM Viewer allows you to move the borders between the image view windows. To do it, locate the cursor on the border so that it would look like  or , and drag the border, holding the left mouse button.

For details, on how to save the image view window configuration, see Section 16.7.3.

The top part displays the toolbar on the left (Fig. 5.2) and the image setup panel on the right (Fig. 5.3).

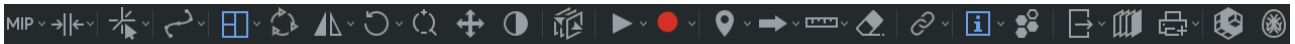



Figure 5.2: Toolbar



Figure 5.3: Image setup panel

To open a study in the **3D view** window of the **MPR reconstruction** tab, click the **3D**  button on the toolbar. A **3D view** window will pop up, in which you will see a 3D model and a standard space orientation panel (for details see Section 3.3).









## 5.2.1 Customizing the Section Windows Arrangement

---

Functionality is available in the **Pro** edition

---

The DICOM Viewer provides the user an opportunity to customize the section windows arrangement in the **MPR reconstruction** tab. You can choose the template from the menu of the button used for section windows arrangement customization.

Depending on the template chosen, this button may appear as: , , , , , , , , or .

To select a windows arrangement template, press the button for section windows arrangement customization or the arrow on the right-hand side of the button. On the drop-down menu (Fig. 5.4) select one of the following options:

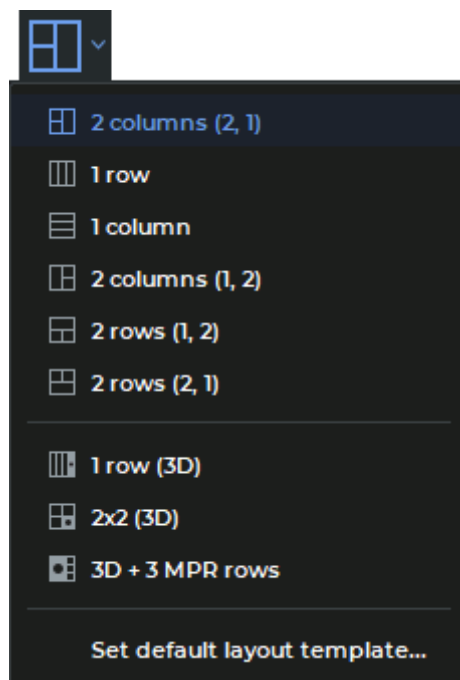













Figure 5.4: Choosing the windows arrangement template

-  **2 columns (2, 1)**. There are two columns for section windows. Two windows are placed in the left column and one in the right one. This template is chosen by default;
-  **1 row**. The three section windows are placed in a single row;
-  **1 column**. The three section windows are placed in a single column;
-  **2 columns (1, 2)**. There are two columns for section windows. One window is placed in the left column and two in the right one;
-  **2 rows (1, 2)**. There are two rows for section windows. One window is placed in the upper row and two in the lower one;
-  **2 rows (2, 1)**. There are two rows for section windows. Two windows are placed in the upper row and one in the lower one;
-  **1 row (3D)**. The three MPR reconstruction section windows and the **3D view** window are placed in a single row;
-  **2x2 (3D)**. There are two columns for windows arrangement. In the left column, there are two section windows, and in the right column, there is one section window and the **3D view** window;
-  **3D + 3MPR rows**. The **3D view** window is placed in the left column. The three section windows are in the right column.

The current windows arrangement template is highlighted on the toolbar and the menu in blue.

To change the current windows arrangement template for **2x2 (3D)** , click the **3D**  button on the toolbar. To get back to the previous windows arrangement template, click the **3D** button on the toolbar again.

To set the default windows arrangement template, click the arrow on the right-hand side of the button for windows arrangement template selection, and then select the **Set default layout template...** option.

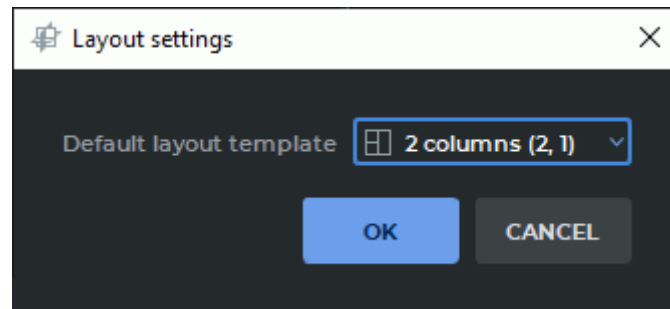

*Figure 5.5: Dialog box for selecting the default windows arrangement template*

In the dialog box that pops up (see Fig. 5.5), select the default arrangement option. Click **OK** to apply the settings or **CANCEL** to cancel.

Next time the series is opened in the **MPR reconstruction** tab, the default windows arrangement template will be applied.

If you switch to the curvilinear reconstruction mode, the windows arrangement templates will be replaced by the curvilinear reconstruction windows arrangement templates (see Section 5.7.6).

## 5.3 Resampling filter

To change the Resampling filter, open the **MPR** main menu, select the **Resampling filter** menu item and in the submenu that opens, select a filter. The active filter is marked with a flag.

The following filters are available:

- Bilinear;
- B-spline;
- Mitchel;
- Catmull-Rom;
- Lanczos3;
- Lanczos5;
- Lanczos7.

By default the Bilinear filter is active.



**When filters are used (except for the Bilinear filter), distortions may occur. If you see any dubious artifacts, select the Bilinear filter.**

## 5.4 Image Filters

Functionality is available in the **Pro** edition



**This function cannot be used for establishing a diagnosis**



Work with filters in the **MPR reconstruction** tab is similar to work in the **Image viewer** tab (see Section 2.6) with two exceptions:

- to apply a filter in the **MPR reconstruction** tab, on the main menu, select **MPR->Filters** and select the desired filter on the list of filters on the main menu. The current filter is highlighted with blue on the list of filters, and marked with a flag;
- in the **MPR reconstruction** tab, a filter is applied to all the cutting plane windows and the involute curve window.

## 5.5 Working with Orthogonal Planes

### 5.5.1 View Modes

Click the **Switch navigation mode** button and select one of the three view modes:

1. The 3D cursor mode. It allows you to drag and rotate orthogonal cutting planes using the mouse. The **Switch navigation mode** button will look as follows: .
2. The on click 3D cursor mode. It allows you to move orthogonal cutting planes similarly to the 3D cursor mode, but the plane lines are visible only during the dragging (while the left mouse button is pressed). The **Switch navigation mode** button will look as follows: .
3. The planes cursor mode. The cutting planes are displayed permanently. Their moving is described in the next section. The rotation of planes is similar to the 3D cursor mode and is described in Section 5.5.2. The **Switch navigation mode** button will look as follows: .

In all the view modes the current plane can be moved in several ways:

- Scroll the mouse wheel. If you scroll the wheel forward, the plane will withdraw, if you scroll it backward, the plane will move nearer. One click of the mouse wheel changes the plane position by the distance equal to the thickness of the slice from the initial series.



- By use the scrollbar on the right side of the section view window to move the section.
- Use the  **Scrolling** tool. Activate the tool on the toolbar by clicking the left/right/middle mouse button and move the cursor up to withdraw the plane or down to move it nearer, holding down the button with which the tool was activated. To learn more about tool control, see Section 1.14.

### 5.5.2 Working with Planes in 3D Cursor Mode

To move orthogonal planes, click the left mouse button at the point you want to move the planes to, or move the mouse, holding the left button. When the button is released, the position of the planes is fixed. To rotate a plane while maintaining orthogonality:

1. Locate the cursor on the radial bidirectional arrow on the plane line (see red arrows in Fig. 5.6). The bidirectional arrow will be highlighted.
2. Move the cursor, holding the left mouse button to rotate the plane by the required angle. The images on the other planes will change.
3. Release the left mouse button to fix the current position of the plane.

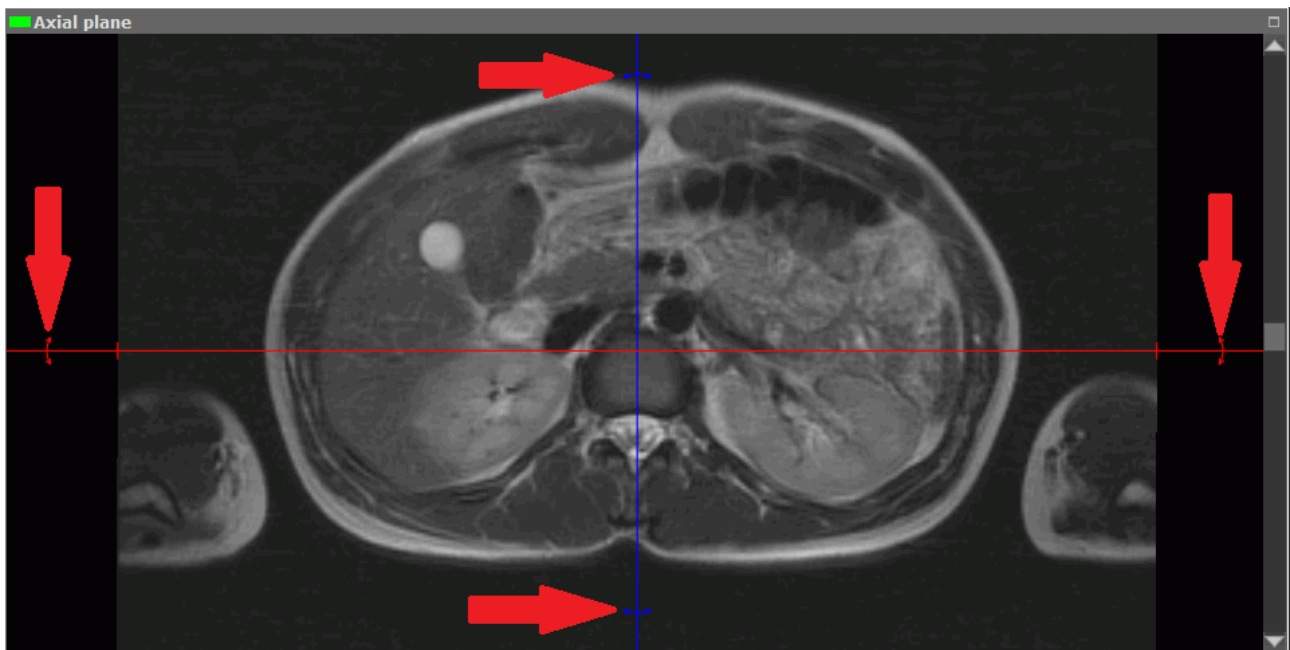

Figure 5.6: Rotate an orthogonal plane

To rotate a plane without maintaining orthogonality, follow the steps above, holding the **Shift** key while performing the step 2.

To undo the rotation of all planes, click the **Undo rotation** button on the toolbar .



**Note that all the other view changes will be undone as well.**

### 5.5.3 Working with Planes in the Cutting Plane Mode

The DICOM Viewer allows you to move planes one by one in the image view modes. To do this:

1. Locate the cursor on the plane line to highlight it.
2. Move the line, holding the left mouse button.

Scroll the images in some window to see how the target plane is moving in the other windows.

For convenience, zoom the image in and out by rolling the mouse wheel, holding the **Ctrl** key.

There are two ways to move images in the window for viewing cutting planes:

1. Move the mouse holding the wheel and the «**Shift**» key on the keyboard. This key combination is set by default. You can disable or change the setting in the **Controllers** tab of the **Image viewer** module (see Section 16.7.1).
2. Activate the **Pan**  tool on the toolbar by clicking the left/right/middle mouse button. To continue work with this tool, use the button with which the tool was activated. To learn more about tool control, see Section 1.14. To move an image, move the cursor around the screen while holding down the mouse button.

This tool is also available from the image context menu and from the **MPR** main menu item.

## 5.6 Series Synchronization in MPR Reconstruction Tabs

Series synchronization is used for viewing series of one or several studies simultaneously. The opportunity to compare series created at different times allows the user to evaluate the changes and improves diagnostic accuracy. Series can be compared in **MPR reconstruction** tabs.

To compare series, open them in **MPR reconstruction** tabs. The tabs may:

- be placed in the main program window or be unattached to it;
- be placed on the same or on different monitor screens. The monitors may be different in size and have different settings (e.g. scaling, resolution, brightness, contrast etc.).

To enable synchronization, click the **Sync series**  button. Synchronization provides the user an opportunity to change window width and level (W/L) settings, move, scale and scroll images from different series in section plane windows. Synchronization is disabled by default. If synchronization is enabled and the user opens a new tab, the new tab will be synchronized with the one that was opened earlier.

To set synchronization types and modes, proceed as follows:

1. Click the arrow on the right-hand side of the **Sync series**  button on the toolbar.

2. Select the synchronization types and modes from the drop-down menu (Fig. 5.7):

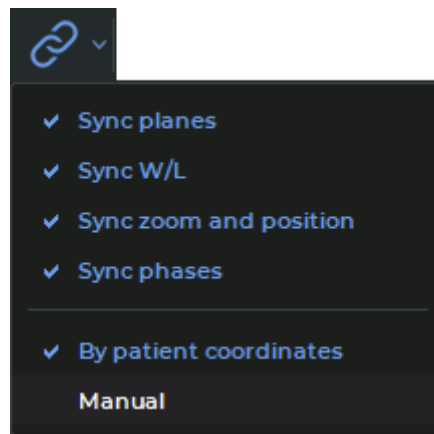

Figure 5.7: Sync series button menu

- **Sync planes.** Planes and rotation angles of orthogonal planes are synchronized in **MPR reconstruction** tab windows (Axial plane, Coronal plane and Sagittal plane). Other **MPR reconstruction** tab windows are not synchronized;
  - in the **By patient coordinates** mode, synchronization is only performed for series with the same *frameOfReferenceUid* tag value. If synchronization is enabled, the orthogonal planes of the new tab are synchronized with the planes of the tab that was opened earlier;
  - in the **Manual** mode, synchronization is performed for series with different *frameOfReferenceUid* tag values. In this case, the same changes regarding scrolling the synchronized and the synchronizing viewer window will be applied in the patient's coordinate system. Planes in synchronized windows will be turned around the line of intersection of orthogonal planes through the same angle;
- **Sync W/L.** Changes in the window width and level (W/L) will be synchronized for series with the **CT** modality. For series with other modalities, synchronization will only be performed if the modalities of the series and the recommended width and level (W/L) values are the same. Series with different modalities cannot be synchronized. The chosen mode has no impact on this synchronization type.
 

If synchronization has been enabled, the window width and level (W/L) values of the tab opened will be synchronized with those of the tab that was opened earlier. Merged series are synchronized layer by layer. Layers are synchronized by their respective numbers (the first layer is synchronized with the first one, the second layer is synchronized with the second one etc.);
- **Sync zoom and position.** The scaling and position changes are synchronized in **MPR reconstruction** tab windows (Axial plane, Coronal plane, and Sagittal plane). Other **MPR reconstruction** tab windows are not synchronized. Merged series are synchronized on the basis of the data for the first layers of the series. This synchronization type functions differently depending on the mode chosen.
  - in the **By patient coordinates** mode:

- \* synchronization is only performed for series with the same *frameOfReferenceUid* tag value;
  - \* the actual image size is taken into account. For sections of the same size, objects are displayed in the same way;
  - \* window centers are synchronized. In the window center, the user sees the projection of the center point of the synchronizing window on the synchronized window section;
  - \* if synchronization is enabled, the scale and the position of the image in the new tab will be synchronized with the scale and the position of the image in the tab that was opened earlier;
- in the **Manual** mode:
- \* the actual image size is taken into account. For sections of the same size, objects are displayed in the same way;
  - \* if the position of the synchronizing window center is changed, the position of the synchronized window center is changed accordingly;
  - \* if synchronization is enabled, the scale of the new tab will be synchronized with the scale of the tab that was opened earlier. The position will be synchronized in compliance with the changes in the synchronizing section position;
- **Sync phases.** The image phases are synchronized by number. If the phase number for the synchronizing series is greater than the total number of phases in the synchronized series, then the phase with the greatest number will be selected for the synchronized series. This synchronization type does not depend on the chosen mode.

## 5.7 Curvilinear Reconstruction



### 5.7.1 Build Surface

---

Functionality is available in the **Pro** edition

---

Curvilinear reconstruction is a section of tissues by a curvilinear surface whose configuration is set by the trajectory passing through the middle of this surface. This trajectory is called a **curve**.

To activate the Curvilinear reconstruction mode, click the **Curve mode** . To get back to the **Multipanar reconstruction** mode, click the **Curve mode**  button again. The curve built in the **Curvilinear reconstruction** mode is not shown in the **MPR reconstruction** mode.

To build a surface:

1. Select the plane in which it would be convenient to start building a curve.
2. Roll the mouse wheel to select the slice where the first point will be located.
3. Fix the first point on the image by clicking the left mouse button.

4. If necessary, move to another slice by rolling the mouse wheel.
5. Move the mouse to select the location of the next point. Fix the point by clicking the left mouse button. The point will appear in the current slice.
6. Repeat Steps 4 and 5 until the last but one point is fixed.
7. Fix the last point by left-clicking the mouse twice. While building the curve, the current section will be displayed in the bottom right-hand window. The other windows will display the projections of the curve on the corresponding planes (Fig. 5.8).
8. If necessary, correct the projections of the curve on the two other planes. For details on how to correct, see the section 5.7.4.

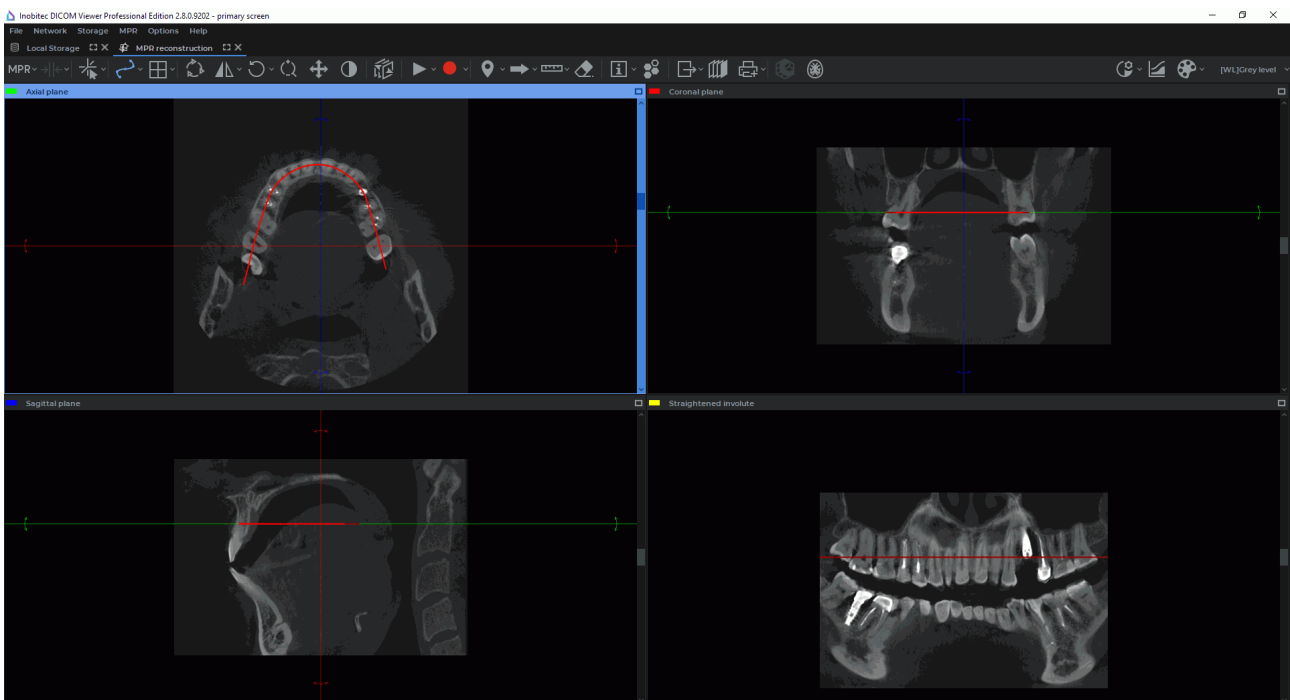

Figure 5.8: Reconstruction by a curve

You can maximize any of the sectional plane windows from the **MPR reconstruction** tab and restore its size in several ways:

- click on the  **Expand** button in the right-hand upper corner of the series window;
- double-click with the left mouse button on the title of the series window;
- if the measurement or graphical annotation tool is activated with the left button, double-click with the left mouse button inside the series window.

You can maximize and restore the size of the **Involute** window using the first or second method.

## 5.7.2 Choosing a Display Mode for an Involute of a Curve

Functionality is available in the **Pro** edition

Click the arrow on the right-hand side of the **Curve mode**  button and choose the display mode for the involute of the curve from the button menu (Fig. 5.9). The current mode is ticked.

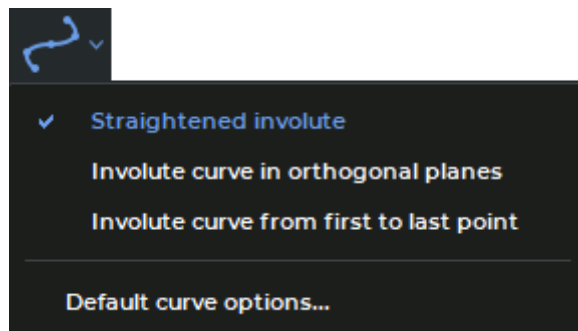

Figure 5.9: Curve mode button menu

- **Straightened involute.** The mode is set by default. In the straightened involute curve window (Fig. 5.10), the curve built by the user is transformed into a straight line. The distortions of space along the curve are marginal and increase with distance from the curve. We recommend this mode when the region of interest is placed near the curve. This option provides for the highest possible level of detail along the curve.

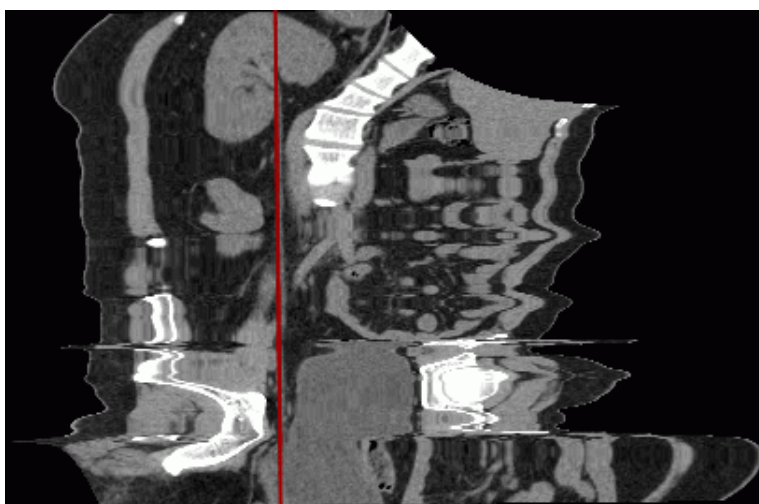

Figure 5.10: Straightened Involute curve mode

- **Involute curve in orthogonal planes** (Fig. 5.11). Unlike the **Straightened involute** mode, this mode provides for a lower distortion degree at a distance from the curve, but the

level of detail along the curve is also lower. Unlike the **Involute curve from first to last point**, this mode is less dependent on the position of points on the curve. It is used when you need an involute similar to an orthogonal projection. The orthogonal projection is chosen automatically to provide for the highest possible level of detail along the curve. Still, the level of detail along the curve is lower compared to other curve modes.



*Figure 5.11: Involute curve in orthogonal planes*

- **Involute curve from first to last point** (Fig. 5.12). Compared to the **Straightened involute** mode, the distortion degree at a distance from the curve is lower, but the level of detail along the curve is also lower. The involute is highly dependent on the position of the first and the last point on the curve. The level of detail along the curve is greater than in the **Involute curve in orthogonal planes** mode.

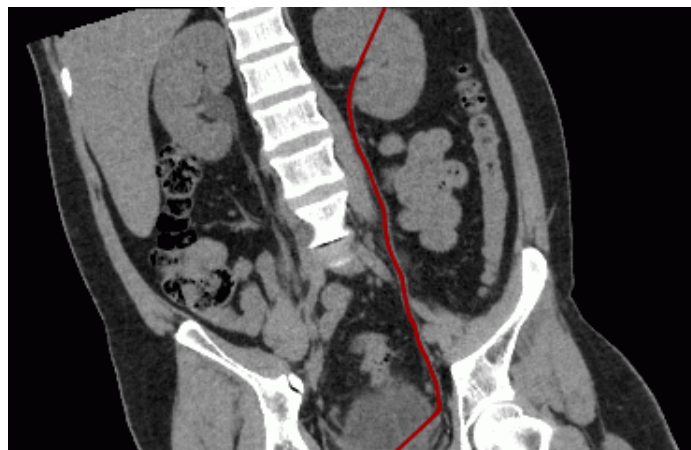

*Figure 5.12: Involute curve from first to last point*

The selected curve mode will be applied the next time the **Curvilinear Reconstruction** mode is activated.

In the **Straightened involute** mode, the **Ruler**, **Polygonal Ruler**, **Angle**, and **Kobb angle** tools cannot be used in the window with the involute.

### 5.7.3 Curve settings

Functionality is available in the **Pro** edition

The parameters of the curve can be set in the **Curve options** dialog box (Fig. 5.13). The appearance and the functions of the **Curve options** dialog box depend on the way you call for it. There are two ways to call for the **Curve Options** dialog box:

1. Click the arrow on the right-hand side of the **Curve mode** button on the toolbar and then select **Default curve options...** from the button menu. You will see the dialog box shown in Fig. 5.13a.
2. Right-click on the curve or a point on the curve and select **Curve options...** from the menu that pops up. You will see the dialog box shown in Fig. 5.13b.

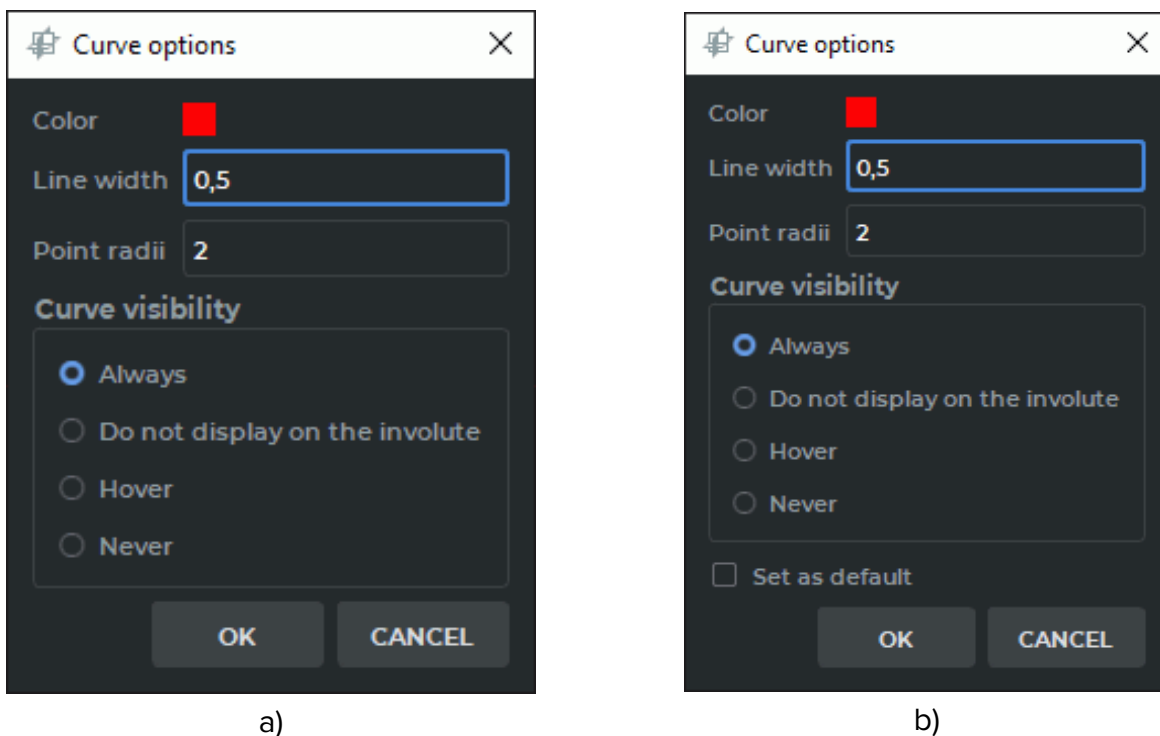

Figure 5.13: Curve options dialog box

You can set up the following parameters:

- **color**;
- **line width in pixels**;



- **point radius** in pixels.

Setting the curve visibility mode:

- **Always.** When the curve is being built, it is shown in all the windows of the tab with plane projections, as well as in the involute window. After the curve has been built, it is always shown in all the windows of the tab with plane projections, as well as in the involute window. This mode is set by default.
- **Do not display on the involute.** When the curve is being built, it is shown in all the windows of the tab with plane projections, except for the involute window. After the curve has been built, it is always shown in all the windows of the tab with plane projections, except for the involute window.
- **Hover.** When the curve is being built, it is shown in all the windows of the tab with plane projections, as well as in the involute window. After the curve has been built, it is shown in all the windows of the tab with plane projections, as well as in the involute window if the cursor is placed on the curve.
- **Never.** When the curve is being built, it is shown in all the windows of the tab with plane projections, as well as in the involute window. After the curve has been built, it is hidden. Choose another visibility mode to see the curve.

If you open the **Curve options** window from the **Curve mode** button menu (Fig. 5.13a), the settings will always be applied to the curve by default.

If you tick the **Set as default** box in the **Curve options** dialog window opened from the curve context menu (Fig. 5.13b), the settings will be applied by default when a curve is built.

To apply the settings, click **OK**. To cancel, click **CANCEL**.

## 5.7.4 Actions with a Curve

---

Functionality is available in the **Pro** edition

---

Actions with a curve can be performed only if the curvilinear reconstruction mode is active. The following actions are available:

- Drag a point. Locate the cursor on the point so that it enlarges, and drag the point holding down the left mouse button or the button to which this tool is assigned. Then release the mouse button.
- Add a point. Locate the cursor on the curve where the point should be added. Right-click the mouse and select the **Add point** item.
- Delete a point. Locate the cursor on the point. Right-click the mouse and select the **Remove point** item.
- Continue a curve. Locate the cursor on one of the border points of the curve. Right-click the mouse and select the **Resume curve** item. Then, perform Steps 3 and 4 of the curve building algorithm.
- Delete a curve. Locate the cursor on any position on the curve or on a point. Right-click the mouse and select the **Remove curve** item.

### 5.7.5 Position of a Curve, Its Nodes and Surface in Space

Functionality is available in the **Pro** edition

By the color of the curve, you can determine which part of the curve is located in front of the current image in space. This part of the curve is brighter than the part behind the image.

In Fig. 5.14, the central part and the third point are a brighter color. This means they are located in front of the current section.

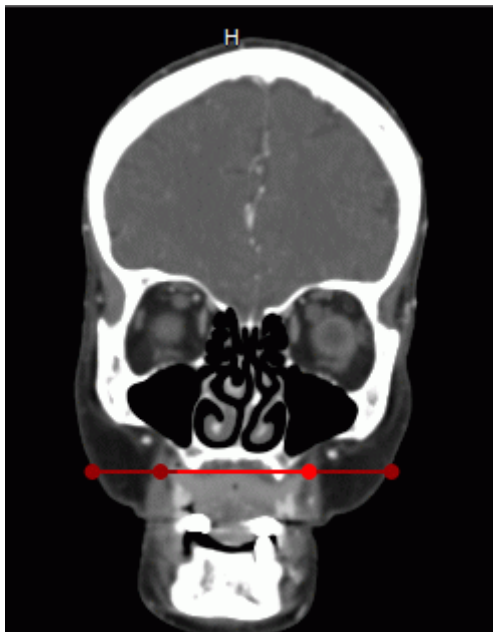

Figure 5.14: Reconstruction by a curve

To make it easier to find a node on the curve on all the projections, locate the cursor on this node. The node will be magnified on all the projections.

To rotate the surface relative to the curve, move the cursor to the bottom right-hand window (**Surface by curve**) and roll the mouse wheel.

To move the cutting planes to the selected point of the curve, move the mouse cursor to the selected point on the curve in the selected window. Left-click while holding down the Ctrl key on the keyboard. The point of intersection of the cutting planes is moved to the specified point on the curve in all the windows.

### 5.7.6 Curved Reconstructions Cross Sections Mode

Functionality is available in the **Pro** edition

The curved reconstruction cross section mode is aimed for viewing the planes that are perpendicular to the curve and evenly spaced.

You can view curve slices if **Curvilinear reconstruction** mode is activated and a curve has been built. To activate the **Curvilinear reconstruction** mode, click the **Curve mode** button .

To select the window arrangement template, click the arrow on the right-hand side of the button or the **Switch layout template** button  and choose one of the options provided (see Figure 5.15):

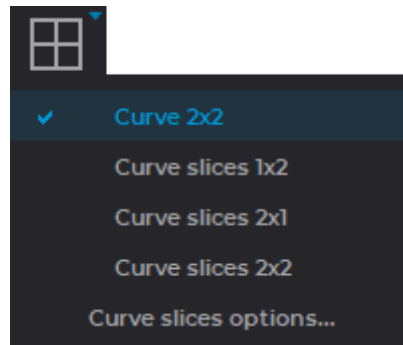







Figure 5.15: Switch layout template

-  **Curve 2x2**. In the **MPR reconstruction** tab, you see three windows with multiplanar reconstruction cutting planes and a **Involute** window. This mode is selected by default.
-  **Curve slices 1x2**. The tab is divided into two windows. The **Involute** window is placed at the top, and the **Curve slices** window is at the bottom.
-  **Curve slices 2x1**. The tab is divided into two windows. The **Involute** window is placed on the left-hand side, and the **Curve slices** window is on the right-hand side.
-  **Curve slices 2x2**. The tab is divided into four windows. The **Axial projection** and the **Volume reconstruction** windows are placed on the left-hand side, while the **Involute** and the **Curve slices** windows are placed on the right-hand side.

The window arrangement template settings will be applied next time you choose the **Curve mode**.

You can maximize any of the sectional plane windows from the **MPR reconstruction** tab and restore its size in several ways:

- click on the  **Expand** button in the right-hand upper corner of the series window;
- double-click with the left mouse button on the title of the series window;
- if the measurement or graphical annotation tool is activated with the left button, double-click with the left mouse button inside the series window.

You can maximize and restore the size of the **Involute**, **3D view** and **Curve slices** windows using the first or second method.

If you see the **Volume reconstruction** window or the segmentation panel in the tab, the volume editing tools are available.

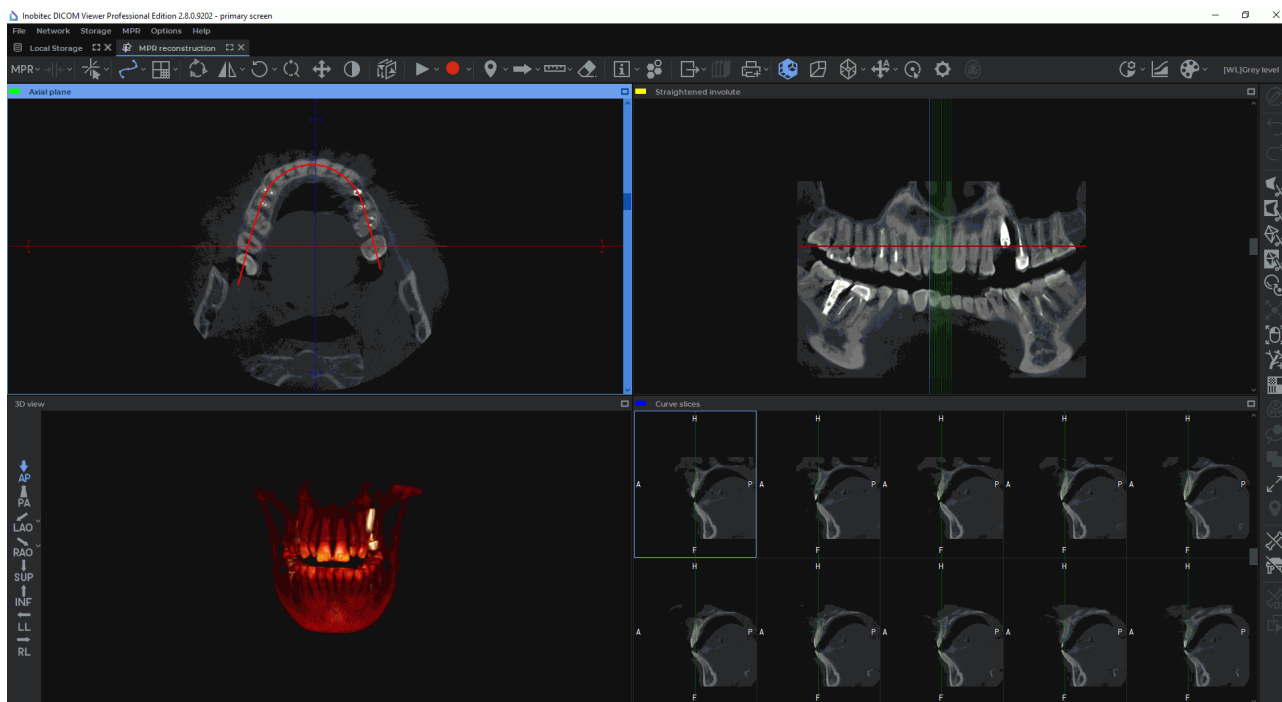



Figure 5.16: Curve slices 2x2 mode

In the **Involute** window, a straightened curve and perpendicular cutting planes projections are shown. When you mouse over a cutting plane in the **Involute** window, the respective plane and projection will be highlighted. The point in which the cutting plane crosses the curve will be marked with a crosshair in the slices window.

To rotate the surface round the curve, mouse over the **Involute** window and scroll the mouse wheel or move the slider in the slices window.

To move the cutting planes along the curve, mouse over the slices window and scroll the mouse wheel or move the slider in the slices window.

To move the cutting planes automatically, activate the **Play** ► tool (see Section 5.10).

To set the curve slices parameters, click the arrow on the right-hand side of the button or the **Switch layout template** button  and choose the **Curve slices options...** (Figure 5.17).

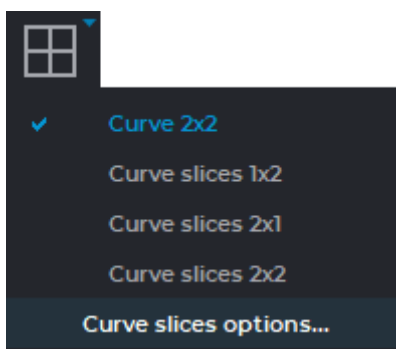

Figure 5.17: Activating the dialog box for curve slices properties

A dialog box will pop up (Fig. 5.18), in which you can set the following parameters:

- the size of the slices window grid. Choose the suitable number of rows and columns (5x2 or 3x3);
- the distance between slices (in millimeters);
- the scrolling increment. Choose one of the two variants: **Auto** (the increment is equal to one voxel) or specify the increment in millimeters;
- the color of the cutting plane lines;
- the thickness on the cutting plane line and the crosshair in pixels;
- the color of the selected cutting plane line and the frame of the slices window;
- the crosshair space in pixels. Set the distance from the lines forming the crosshair to its virtual center;
- the size of the crosshair in pixels.

If you have checked the **Set as default** box, these settings will be used by default when you switch to the Curve slices mode.

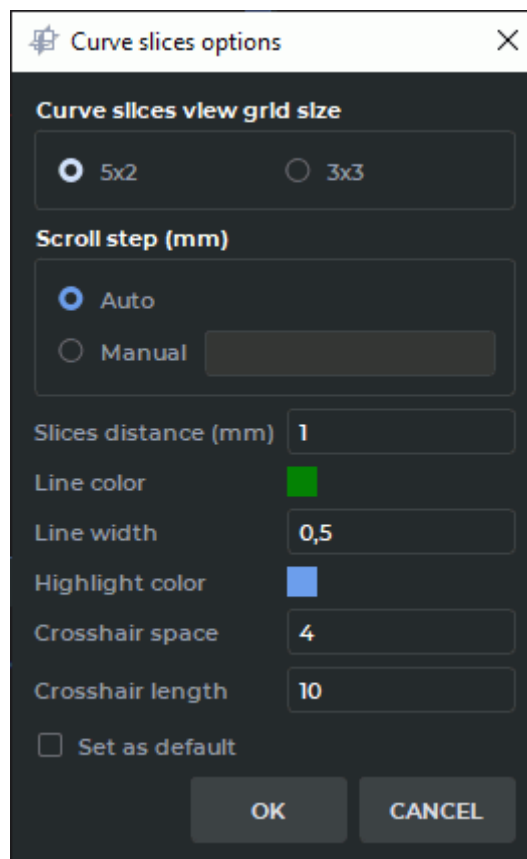

Figure 5.18: Curve slices options

There are two ways to activate the **Curve slices options** dialog box from the right-click menu:

1. Mouse over one of the cutting planes in the **Involute** window. Right-click and choose **Set curve slices options...**
  
2. Mouse over the crosshair of one of the slices in the slices window. Right-click and choose **Set curve slices options...**

**Rotate, Zoom, Pan** and **Adjust W/L** tools are simultaneously activated for all the slices.

DICOM Viewer records videos, exports and prints images from the **Involute** window or the slices window, whichever is active.

In the slices window, only the image from the top left-hand cell will be printed. To print or export the slice you need, move the cutting planes along the curve, so that the slice you need appears in the top left-hand cell. You can move the cutting planes by scrolling your wheel or moving the slider in the slices window.

In the slices window, video is recorded for the top left-hand cell. To record a video for the slice you need, move the cutting planes along the curve, so that the slice you need appears in the top left-hand cell.

To record a video, activate the **Start video record** tool  (see Section 5.11).

To escape from the curve slices mode, click the **Curve mode** button.

## 5.8 Displaying Section Planes on 3D Models

The **MPR planes on 3D view**  tool is used for setting up and displaying section planes on 3D models in the **3D view** window.

The tool is available on the toolbar in **MPR reconstruction, Vessel analysis** and **Coronary artery analysis** tabs only when a 3D reconstruction is displayed in the **3D view** window. In the Fig. 5.19, , you can see an example of section planes displayed on a 3D model in the **3D view** window of the **MPR reconstruction** tab.

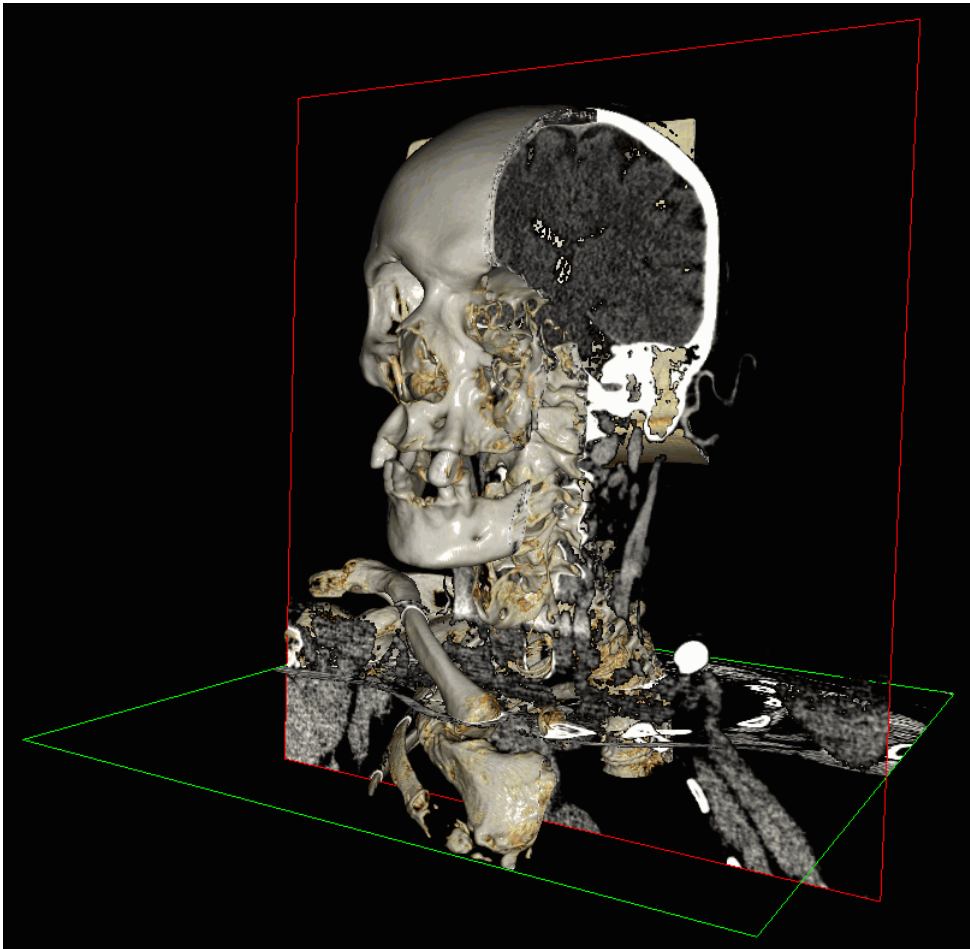



Figure 5.19: Section planes displayed in the **3D view** window

To enable the mode for displaying section planes, click the **MPR planes on 3D view**  button on the toolbar.



**The tool is only available when a 3D reconstruction is displayed in the 3D view window. To enable the 3D reconstruction display mode, click the 3D  button on the toolbar.**

To enable the planes display, click the arrow on the right-hand side of the **MPR planes on 3D view**  button and select the display mode on the button menu (see Fig. 5.20):

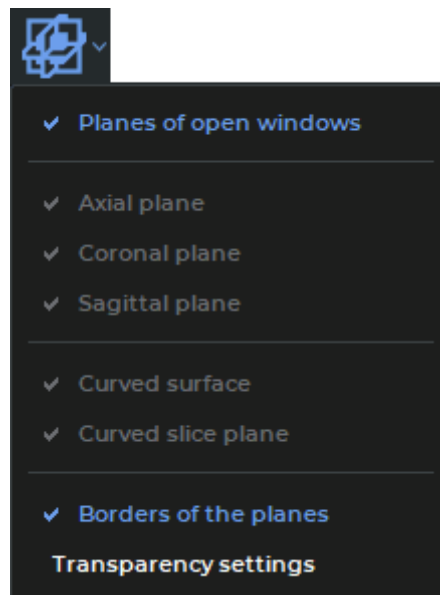

Figure 5.20: MPR Planes on the 3D View button menu

**Planes of open windows.** In the **3D view** window, the section planes that are shown in the open windows of the tab are displayed. This mode is enabled by default.

To enable the display of certain cutting plains, disable the **Planes of open windows** mode. You can enable the display of the following planes:

- **Axial plane;**
- **Coronal plane;**
- **Sagittal plane;**
- **Curved surface<sup>PRO</sup>.** A curvilinear surface may be displayed in the **3D view** window after a curve is built (see Section 5.7.1). On the curvilinear surface plane, the centerline is shown in dark red;
- **Curved slice plane<sup>PRO</sup>.** The curve slices are displayed when the curve slices window is opened for the first time (see Section 5.7.6). In the **3D view** window, the plane of the first slice is displayed.

All the planes are displayed by default.

**Borders of the planes.** The mode is used to enable/disable the display of borders of the cutting planes on a 3D model. The display of borders of the planes is enabled by default.

**Transparency settings.** In the dialog box that pops up (Fig. 5.21), move the slider to set up the planes transparency. The extreme right position equals maximum opacity. The maximum opacity level is set by default.



**Planes transparency is not supported:**

- if the CPU has been chosen as the visualization device;
- if the program is installed on Linux;
- if the program is installed on macOS and any device different from Metal is used as the visualization device.

To make the background visible, uncheck the **Transparent background** box. The box is checked by default. To close the transparency settings dialog box, click the **CLOSE** button.

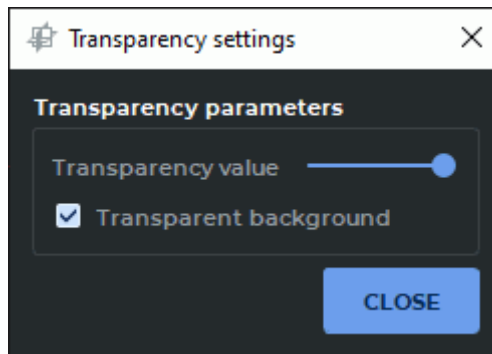

Figure 5.21: Dialog box for setting cutting planes transparency

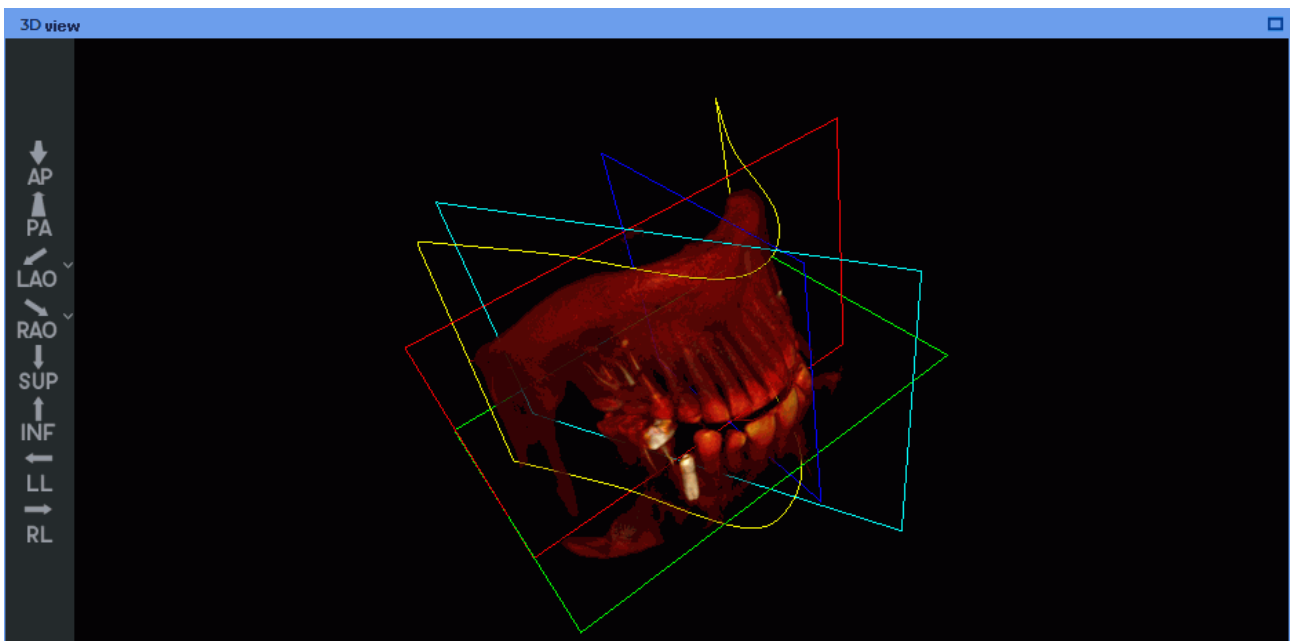



Figure 5.22: Displaying cutting planes on a 3D model in the 3D View window

The colors of the plane borders are the same as the colors of the windows of the respective

cutting planes. On the curvilinear surface plane, the centerline is shown in dark red. The borders of the curve slice plane are shown in blue.

## 5.9 «Render settings» Tool



The **Render settings**  tool allows for setting the rendering quality of the 3D model and the opacity threshold in the **3D view** window. The tool is available on the toolbar only when a volume reconstruction is displayed in the **3D view** window. The operation of the tool is described in Section 3.14.

To enable the volume reconstruction mode, click the  **3D** button on the toolbar of the **MPR reconstruction** tab.

## 5.10 The Play Tool

The DICOM Viewer allows you to automatically play slices and phases in the MPR View windows and the Volume Reconstruction window. To configure the playback, click the arrow on the right side of the **Play**  button and specify the necessary parameters in the button context menu.

1. If the series contains several phases, then the DICOM Viewer allows you to switch between the slice and phases playback. To switch select the **Play phases** or the **Play slices** item from the **Play** button context menu. The selected item is marked with a flag. Only the items suitable for this series are available on the context menu.
2. Select the speed (5, 10, 20 or 25 frames per second). If you want to set a different playback speed, select the **User defined...** item and in the dialog that opens set the value from 1 to 100. The selected speed will be marked with a flag.
3. If you want to play phases and slices cyclically, select the **Loop** item. The item will be marked with a flag. To disable the cyclic playback, select this command again. The flag will be removed.

To start playback, click on the  **Play** button on the toolbar. During playback, the button looks like . To end playback click the  button.

## 5.11 Video recording

---

Functionality is available in the **Pro** edition

---

The DICOM Viewer allows you to record video for the volume model view window. The following objects will be recorded:

- tissues;

- measurements;
- annotations;
- markers;
- tags;
- orientation cube;
- the **Select model point** tool label.



The other features of the tool in the MPR View windows are similar to those described in Section 2.15 and the features in the Volume Reconstruction window are similar to those described in Section 3.7.

## 5.12 Markers

### 5.12.1 General

A marker is a point, line or polygonal line in space, associated with a model. The DICOM Viewer allows you to display the length of the marker line and the polygonal marker line and the angles of the polygonal marker line.

The following tools are used to add markers: **Marker**, **Line marker** and **Polygonal Line marker**. To select one of these tools, click on the arrow on the right side of the tool selection button. The button will look different depending on the selected tool:

	<b>Marker</b> (selected by default)
	<b>Line marker</b>
	<b>Polygonal Line marker</b>

Activate/deactivate the currently selected tool by clicking the left/right/middle mouse button. To continue work with this tool, use the button with which the tool was activated. To learn more about tool control, see Section 1.14.

The added markers are located in the displayed slice.

### 5.12.2 Add Markers

To add a marker as a point:

1. Activate the **Marker** tool by clicking the  button on the toolbar.
2. Mark a place on an image by clicking the left mouse button. The marker will appear in all three windows.

After adding all the markers, deactivate the **Marker** tool.

This tool is also available from the image context menu and from the **MPR** main menu item. Activation is only possible with the left mouse button.

### 5.12.3 Add Line Markers

To add a Line marker:

1. Activate the **Line marker** tool by clicking on the  button on the toolbar. To continue work with this tool, use the button with which the tool was activated. To learn more about tool control, see Section 1.14.
2. A marker line can be built in two ways:
  - Mark the first point by clicking the mouse button. If required, go to the next section by rotating the mouse wheel. Move the cursor over the screen to the second point of the marker line. To fix the current point, click the mouse button.
  - Click the mouse button at the first point of the marker line and move the cursor to the endpoint while holding the mouse button. To go to the next section, rotate the mouse wheel while holding the mouse button. To fix the endpoint, release the mouse button.
3. To cancel an incomplete addition, press **Esc**.

When building a marker line, the start and the end points are chosen on the selected sections. This allows for performance of measurements between the points placed on different sections. You can tell by the color of the marker line which part of it is in front of the current image. This part of the line will be brighter than the part placed behind the image (see Fig 5.23).

After adding all the line markers, deactivate the **Line marker** tool.

This tool is also available from the image context menu and from the **MPR** main menu item. Activation is only possible with the left mouse button.

Length measurements made with marker lines are saved in a file project.

### 5.12.4 Poilygonal Marker line

To add a Poilygonal Marker line:

1. Activate the **Poilygonal Line marker** tool by clicking on the  button on the toolbar.
2. Roll the mouse wheel to select the slice where the first point will be located.
3. Mark a point by clicking the mouse button.
4. If necessary, move to another slice by rolling the mouse wheel.
5. Move the mouse to select the location of the next point. Fix the point by clicking the mouse button.
6. Repeat steps 4 and 5 until the last but one point is fixed.

7. Fix the last point by double-clicking the mouse.
8. To cancel an incomplete addition, press **Esc**.

When building a polygonal marker line, the start and the end points, as well as the intermediate points, are chosen on the selected sections. This allows for performance of measurements between the points placed on different sections. You can tell by the color of the marker line which part of it is in front of the current image. This part of the line will be brighter than the part placed behind the image (see Fig 5.23).

After adding all the polygonal line markers, deactivate the **Polygonal Line marker** tool.



To continue the polygonal marker line, move the cursor to the end point of the line, right-click and select the **Continue line** item.

This tool is also available from the image context menu and from the **MPR** main menu item. Activation is only possible with the left mouse button.

The length and angle measurements made with polygonal marker lines are saved in the project file.

### 5.12.5 Actions with Markers

The following actions are available:

- Drag a point or line and polygonal line marker points. Locate the cursor on the marker or point so that it would look like  , and drag it, holding down the left mouse button or the button to which this tool is assigned. The location of the marker will change accordingly in all the windows. The marker will be moved parallel to the displayed slice.
- Remove. Locate the cursor on the marker so that it would look like  . Press the **Delete** key on the keyboard or right-click the mouse and select the **Remove marker** item.
- Remove all the markers. If you need to delete all the markers, locate the cursor on any marker so that it would look like this:  , right-click the mouse and select the **Remove all markers** item or select the corresponding item from the **Marker** tool menu.

### 5.12.6 Marker Properties

You can set the following properties:

- **Text**;
- **Text size**;
- **Diameter** or **Line width**;
- **Color**;
- **Show length** (for Line Markers);
- **Show angle** (for Polygonal Line Markers).

To set properties for previously added marker, locate the cursor over the marker, right-click and select the **Set marker properties...** item.

To set the default marker properties, click the arrow on the right side of the **Marker** button and select one of the **Default marker options...**, **Default marker line options...** or **Default marker polygonal line options...** items.

The parameters provided will be applied by default when new markers are added or new marker lines are built.

### 5.12.7 Position of Markers in Space

If the marker is in or near the current slice, it is displayed as a circle; otherwise, it is displayed as a ring with a dot in the center. The further the marker slice is from the current slice, the darker the marker is.

You can determine how the marker line is located relative to the plane of the current image, judging by the color of the marker line. The line (or its part) located in front of the plane is brighter than the line (or its part) behind the plane. In Fig. 5.23, the bottom part of the line is located behind the image.



Figure 5.23: Position of Line Marker in Space

## 5.13 Reconstruction Modes. Slice Thickness

### 5.13.1 Render Modes

To switch between modes, the **Switch render mode** button on the toolbar is used.

Four render modes are available:

1. The **MPR** mode. Sections are available for viewing. Set by default.
2. The **MIP** mode. A slice of a particular thickness is viewed instead of a section. A point with maximum intensity in the slice is projected on each point in the image. For details on how to set the thickness, see the next section.
3. The **MinIP** mode. Similar to the previous mode, but points with minimum intensity are projected on the image.

4. The **AIP** mode. Similar to the previous mode, but the intensity of each point equals the average intensity of the points projected on this point in the image.

This tool is also available from the **MPR** main menu item.

### 5.13.2 Slice Thickness

In the **MIP**, **MinIP** and **AIP** render modes, the slice thickness is set using the **Thickness**  button on the toolbar. Click the button and select the predefined values from the list, or click the **User defined** button to specify your own value. In the projection window, the slice borders are marked by lines (the red arrows in Fig. 5.24).

To set the thickness of solely the slice which is projected on a certain plane, move the cursor to any line, marked by the arrows in Fig. 5.24, for the corresponding slice and move it, holding the left mouse button.

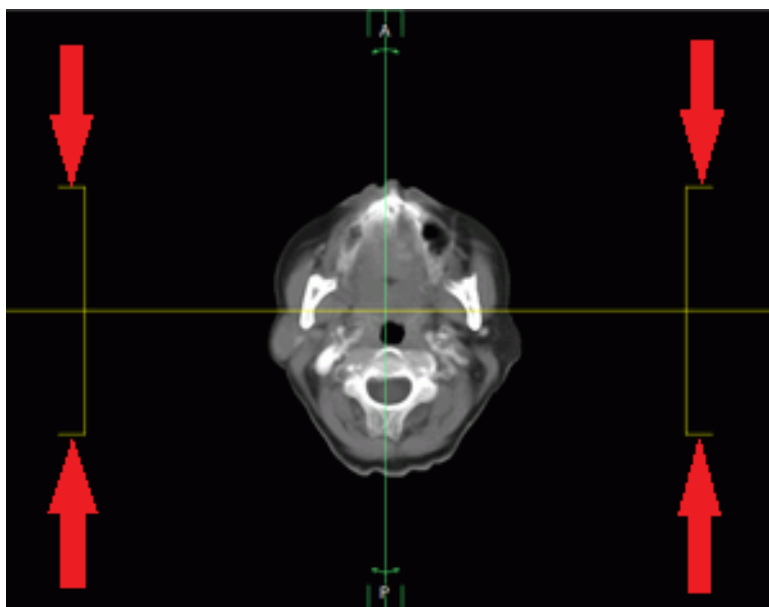



Figure 5.24: Slice borders

Setting the thickness is also available from the **MPR** main menu item.

## 5.14 Rotate Image in the Section Plane

To rotate an image by an angle multiple of 90 degrees:

1. Activate the window in which the target image is located. To do this, click the left mouse button on the window area or header (marked by the arrow in Fig. 5.25).
2. Click on the arrow on the right side of the **Rotate**  button and select the angle from the drop-down menu.
3. To restore the initial image position, select the **Set image rotation angle 0°** item.

- To rotate an image by an arbitrary angle, activate the **Rotate**  tool by clicking the left/right/middle mouse button. To continue work with this tool, use the button with which the tool was activated. To learn more about tool control, see Section 1.14. Rotate the image by moving the mouse while holding down the button that activated the tool.

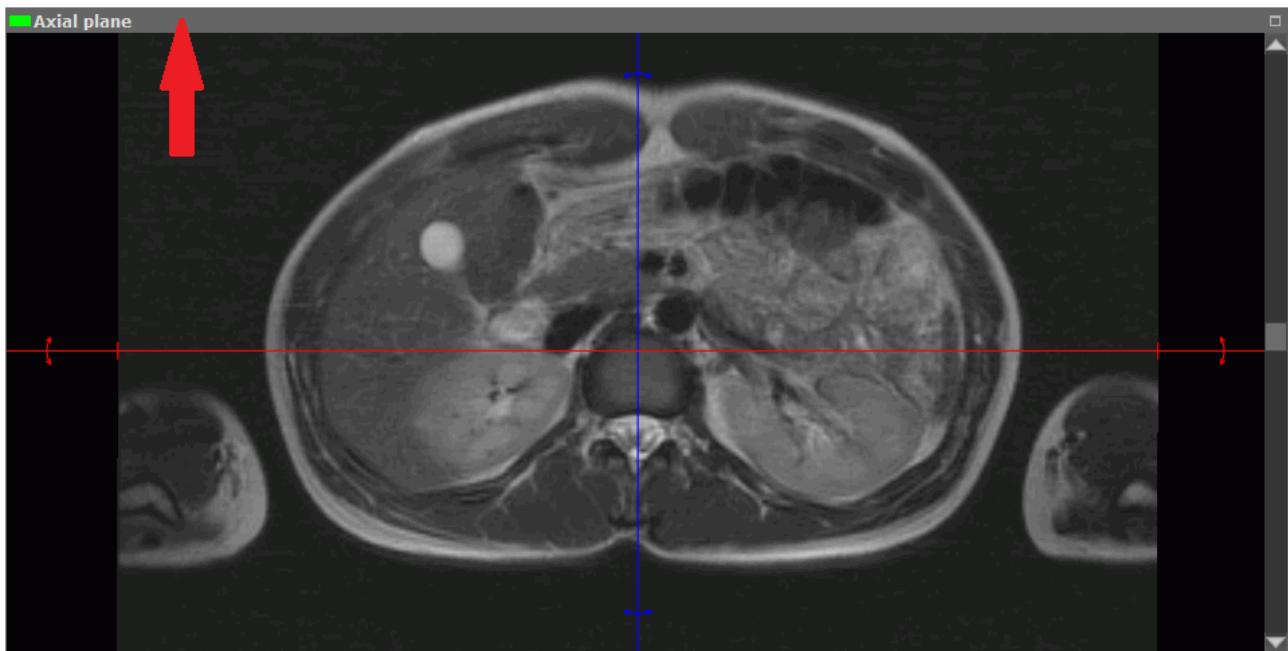



Figure 5.25: Window header

To cancel the rotation of all the images, click the **Reset views orientation** button on the toolbar .



**Note that all the other view conversions will be undone as well.**

This tool is also available from the image context menu and from the **MPR** main menu item.

## 5.15 Mirror Image Horizontally/Vertically

The tool is described in Section 2.35.

## 5.16 Show labels tool

The tool is described in Section 2.26.

On the **MPR reconstruction**, tab this tool has 3 menu items, which can be checked independently:

- **Show orientation cube;**



- **Show orientation letters;**
- **Show render annotations.**

This tool is also available from the image context menu and from the **MPR** main menu item.

## 5.17 Export Images

The export of a model to DICOM or to an image is similar to the image export described in Section 2.27.

## 5.18 Reslice

---

Functionality is available in the **Pro** edition

---

The reslice functionality allows you to export the series generated in the multiplanar reconstruction window, setting the area, size, step images and other parameters.



**The MPR window doesn't show the source data, it shows 3D structure slices. That is why tweening errors may occur. To avoid tweening errors, when creating a series, you should use the MPR reconstruction based on the series obtained from the modality, rather than the series that was created before.**

To reslice:

1. Select the plane whose sections should be exported to the series. To do this, click the left mouse button on the corresponding window.
2. Open the image export window by clicking on the **Reslice**  button. The window will look as shown in Fig. 5.26.

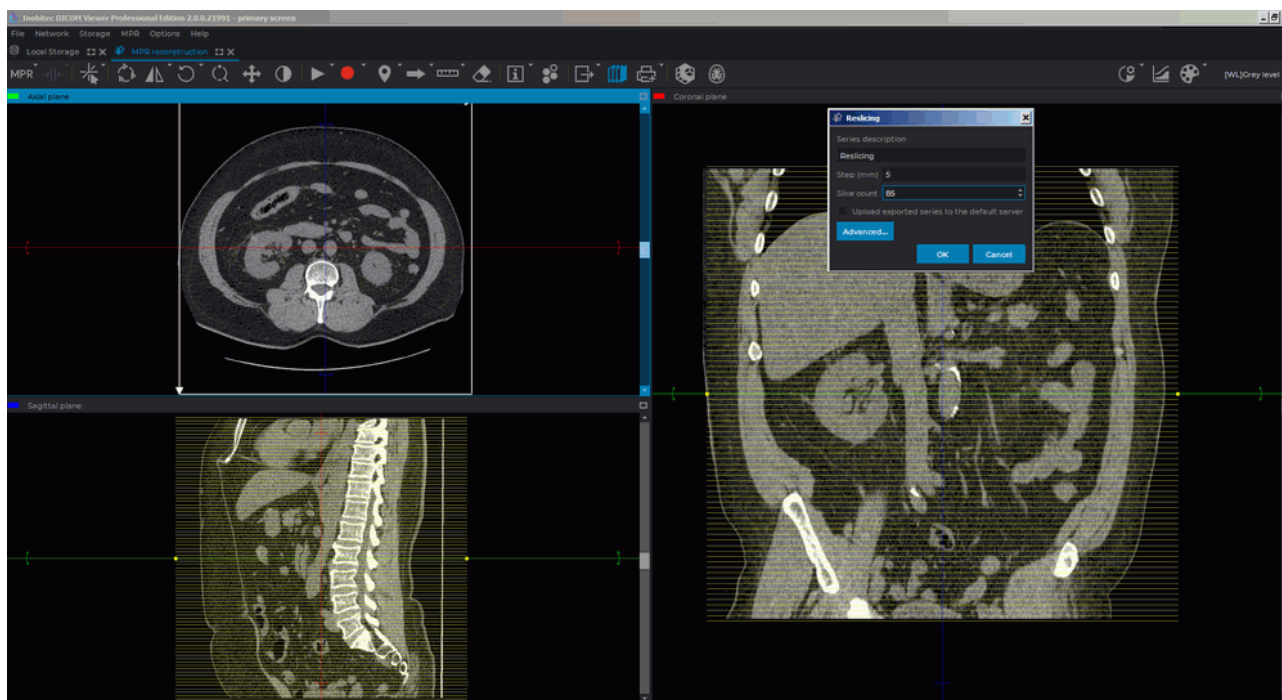

Figure 5.26: Reslice

3. Enter the series description in the dialog shown in Fig. 5.27.

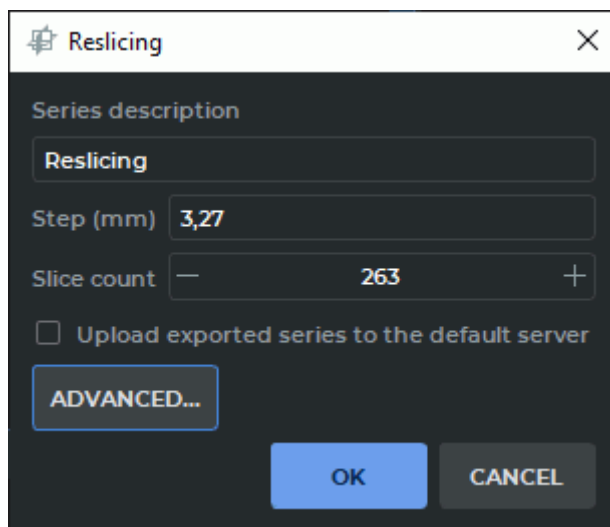

Figure 5.27: Reslice dialog box

4. Set the step to generate images in the series.
5. Set the images number.
6. If you need to load the exported images to the DICOM server at once, check the option **Upload image to the default server**. If the default server is not specified in the DICOM Viewer, this option will be inactive.

7. To set additional parameters for the series, click on the **ADVANCED...** button. The dialog box with additional parameters is shown in Fig. 5.28.

If you want the reconstruction mode and the slice thickness to be taken into account while capturing images, check the **Use MIP settings** box. For details on reconstruction modes, see Section 5.13.1.

8. Set the image size if necessary.
9. The image area that is to be exported is highlighted by a white frame positioned symmetrically with respect to the intersection point of the cutting planes. To resize the area, drag the white frame, holding the left mouse button.
10. To rotate the reslice area, rotate the cutting planes. The cutting planes are described in Section 5.5.2.
11. The other two planes display projections of the exported slices. If necessary, move or rotate them in the same way.
12. Click **OK** to export the series or **CANCEL** to cancel.

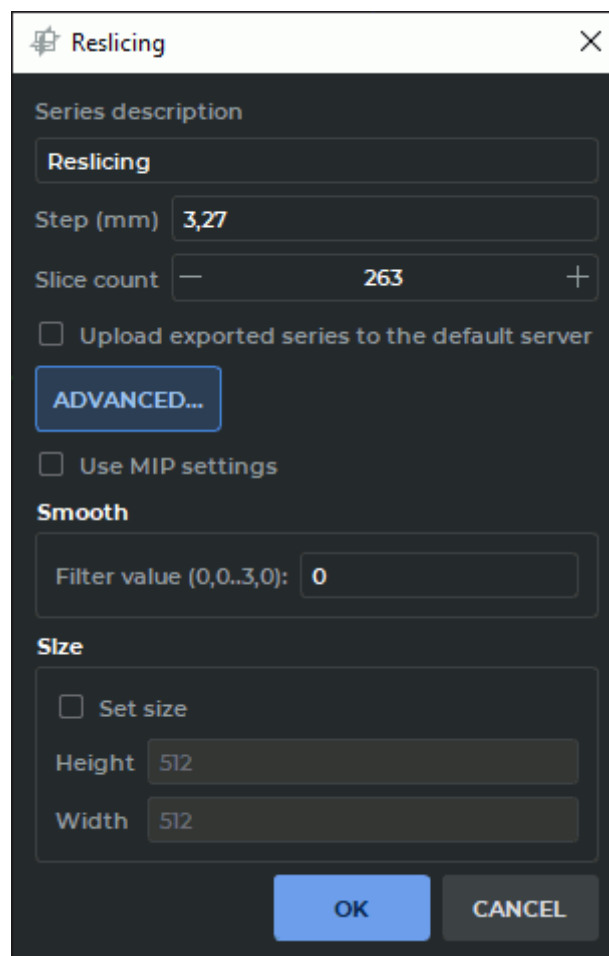



Figure 5.28: Reslice dialog box with additional parameters

This tool is also available from the **MPR** main menu item.

The **Reslice**  button is not available for the **Involute** and **Curve slices** windows in the **MPR reconstruction** tab.

## 5.19 Measurements



The MPR window doesn't show the source data, it shows 3D structure slices. That is why tweening errors may occur



As the images in MinIP, MIP, and AIP modes are the results of original images processing, tweening errors may occur. The measurements performed in these modes may be erroneous



The measurement accuracy is up to one screen pixel. As a screen pixel is smaller than a source image pixel, the true linear measurement accuracy is up to one source image pixel. Errors may also occur in density measurements. The most accurate measurements are performed with bilinear interpolation (see Section 5.3)



The MPR mode is not meant to be used for PET studies, use the specialized module (see Section 9).



Errors may occur when intensity is measured in a certain point. In this case, the intensity value will be marked by an asterisk. For accurate measurements, use the bilinear interpolation filter (see Section 5.3).

The measurements are conducted in the same way as for flat images (Section 2.19).

## 5.20 Annotations

Annotations are described in Section 2.32.

## 5.21 Volume Reconstruction window

In the Multiplanar Reconstruction window, you can view and edit a 3D model. To open it, click the **3D**  button on the toolbar. The model will be displayed in the bottom right-hand window. The following tools are available for working with the model:

- **Clipping box;**
- **MPR planes on 3D view;**
- **Center;**
- **Select model point;**
- **Ruler and Polygonal ruler;**

- all the tools for editing the model and creating segmented structures<sup>PRO</sup>.

The Volume Reconstruction window is described in Chapter 3.

## 5.22 Diffusion Tensor Imaging (DTI) Mode

Functionality is available in the **Pro** edition



### Tractography results cannot be used for establishing a diagnosis

The DICOM Viewer allows you to show the result of the fiber tractography for the series of Diffusion MRI. Fig. 5.29 shows tracks which are the result of brain tractography.

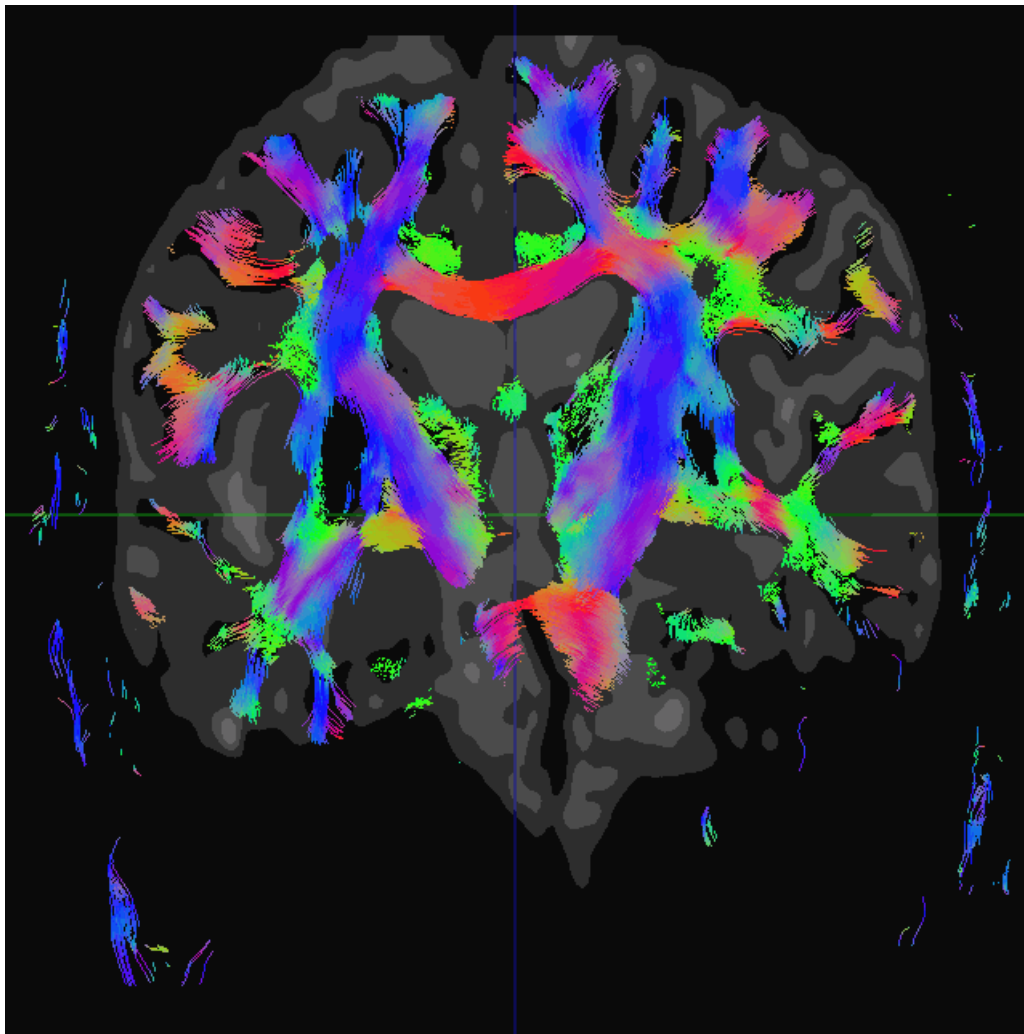



Figure 5.29: Result of brain tractography

The tracks which are the result of tractography are referred to as fibers in the DICOM Viewer interface and in the User Manual.

### 5.22.1 Open series in DTI Mode

Functionality is available in the **Pro** edition

The tractography will be performed automatically for the series made in the DTI mode when you open it in the Multiplanar Reconstruction Mode. To display fibers over the images not made in the DTI mode (for the same study):





1. Open the series not made in the DTI mode.
2. Click the **DTI**  button on the toolbar.
3. In the dialog that appears, select the series made in the DTI mode.
4. Click **SELECT** to display fibers over the images or **CANCEL** to cancel.

### 5.22.2 Select Visible Fibers

Functionality is available in the **Pro** edition

If you want to make only some fibers visible, specify the areas through which the fibers pass as visible or invisible. Use the ROI tools from the **Fibers** panel. The operation of these tools is similar to using ROI from the toolbar at the top of the window (see Section 2.19.6). Note that you cannot use the ROI tools from the top toolbar to adjust the visibility of the fibers.

To make some fibers visible:

1. Open the series made in the DTI mode or display fibers over the series not made in the DTI mode.
2. Select the plane and the image in which you want to specify the area through which the target fibers pass.
3. Open the Segmented Structure panel by clicking the **Segmented structure panel**  button. The **Fibers** panel will be located at the bottom.
4. Specify the desired area using the ROI tools (**Rectangle** , **Ellipse** , **Polygon** ) on the **Fibers** panel. The similar tools from the toolbar at the top of the window cannot be used to adjust the visibility of the fibers. After making the ROI, only the fibers passing through the region specified by the ROI will be visible. A new group appears on the **Fibers** panel. This group includes the new ROI.
5. To delete ROI select it and click the **Remove ROI**  button on the **Fibers** panel.

6. To make fibers which pass through the area invisible, check the **Inverse** box for this ROI on the **Fibers** panel.
7. To hide ROI, check the **Hide ROI** box for this ROI (marked with number «1» in Fig. 5.31). To hide all the ROIs in the group, check the **Hide ROIs** box for this group (marked with number «2» in Fig. 5.31). To hide all the ROIs, check the **Hide ROIs** box in the header of the table (marked with number «3» in Fig. 5.31). The visibility of the ROI does not affect the visibility of the fibers.
8. Make new ROIs until you see only the target fibers. Only the fibers which pass through all the ROIs are visible (or invisible if you check the **Inverse** box).

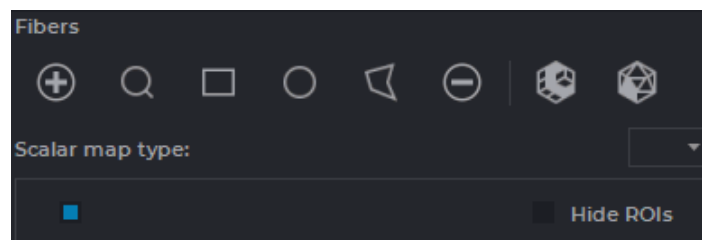

Figure 5.30: The Fibers Panel

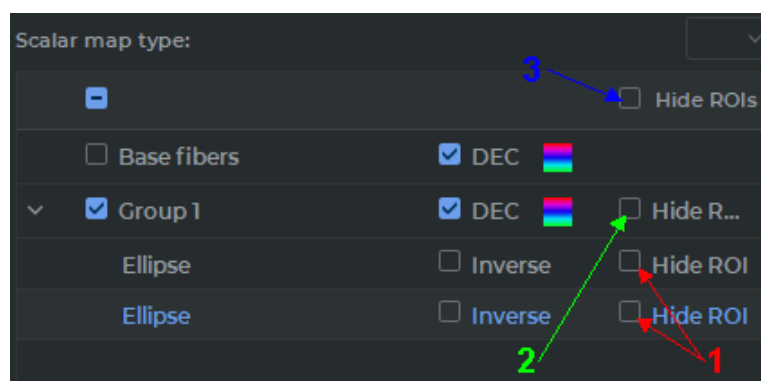



Figure 5.31: ROIs visibility

When you create the first ROI, a group is automatically created for it. New ROIs are added to the same group.

The flag to the left of the name of the ROI group and the **Base fibers** group allows you to display or hide the relevant fibers. If the box is checked, then the fibers are displayed. This flag does not affect the visibility of fibers, it only allows you to temporarily hide them, for example, to adjust the visibility of other fiber groups.

To make other fibers visible without changing the visibility of the fibers previously made visible:

1. If necessary, hide the previously displayed fibers by unchecking the box to the left of the fiber group name.

2. Show the base fibers by checking the box on the left of the **Base fibers** group.
3. Add a new group by clicking the **Add ROI group**  on the **Fibers** panel.
4. Add a new ROI to make only the target fibers visible. To ensure that the ROI is in the right group, this group must be selected before making a ROI.
5. If necessary, show some other fibers by checking the boxes to the left of the other group names.

To show the image containing a certain ROI, select this ROI in the table and click the **Find ROI**  button on the **Fibers** panel.

### 5.22.3 Fiber Color

---

Functionality is available in the **Pro** edition

---

By default, fibers are colored in accordance with the DEC (Direction Encoded Color) scheme. It means that the color of a fiber depends on its direction. You can set color for each group manually. Color is indicated by the  pictogram in the DEC mode and by the single-colored pictogram if the color is set manually.

To set color manually, uncheck the **DEC** box for the group, double-click the left mouse button on the color pictogram and in the dialog button that appears, select the color or leave the default color.

To switch to the DEC scheme, check the **DEC** box.

### 5.22.4 Scalar Maps

---

Functionality is available in the **Pro** edition

---

The DICOM Viewer allows to display scalar maps for series made in the DTI mode. The following types of maps are available:

- Fractional Anisotropy (FA);
- Mean Diffusivity (MD);
- Axial Diffusivity (AD);
- Radial Diffusivity (RD).

By default, the maps are not displayed. To display the map, select the target map on the drop-down list **Scalar map type** (Fig. 5.32). To hide the map, select an empty value from the list.



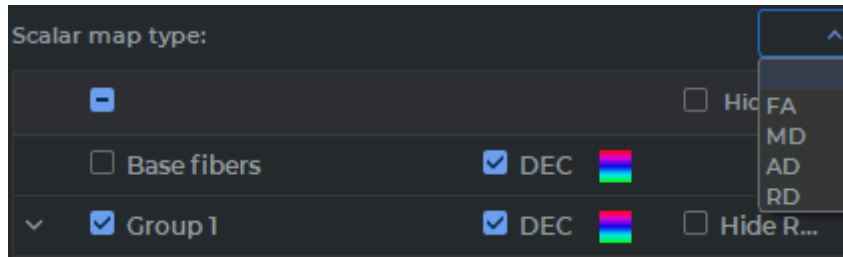



Figure 5.32: Select scalar map

### 5.22.5 Building a Surface

Functionality is available in the **Pro** edition

DICOM Viewer allows for building fiber surfaces in the **Multipanar reconstruction** window. Select a group of fibers or a ROI for the selected group of fibers. A polygon surface is built for a group of fibers. If you change the ROI visibility for the group of fibers, it won't have any impact on the surface to be built.

Each fiber is represented by a solid cylinder-shaped figure. The polygonal surface is built on the basis of such parameters as the cylinder diameter and the number of points on the cylinder circumference.

To set the parameters for the surface model surface, click the button **Convert tracks to polygonal mesh**  on the **Fibers** panel. In the dialog box for the surface model parameters (Figure 5.33), provide the following parameters:

1. **Fiber contour points**, from 3 to 360. In most cases, six points are enough to ensure decent accuracy. The accuracy of the model, the time required for estimation and the memory space required increases with the number of points on the contour.
2. **Fiber diameter**, from 0.01 to 10 mm.

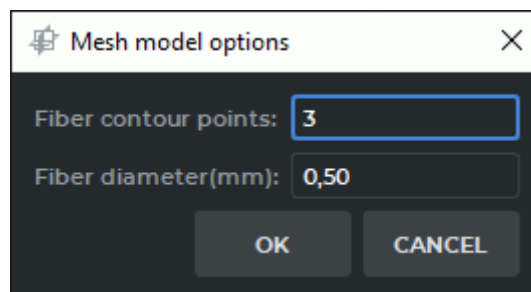



Figure 5.33: The dialog box for surface model options

Click **OK** to apply the settings or **CANCEL** to cancel.

A surface is created for the chosen group of fibers and added to the list on the **Segmented structure** panel. The name of the surface, as well as the name of any structure without a volume model, is shown in italics. The name of the surface is copied from the name of the group on the **Fibers** panel.

You can view the built surface in the **MPR reconstruction** tab. To open a volume reconstruction, click the **3D** button  on the toolbar. The volume reconstruction will be displayed in the right-hand bottom window.

The work with the structures from the segmented structure list is described in Section 6.4. The surfaces created can be exported or imported. For details on surface and structure export and import, see Section 6.7. The procedures of saving and opening segmentation projects and DTI projects are described in Section 6.11.

### 5.22.6 Creating a Voxel Model of Fibers

---

Functionality is available in the **Pro** edition

---

DICOM Viewer allows for building voxel models of fibers in the **Multipanar reconstruction** window.

Select a group of fibers or a ROI for the selected group of fibers. A voxel model is built for a group of fibers. If you change the ROI visibility for the group of fibers, it won't have any impact on the model to be built.

To build a voxel model, click the **Voxelize tracks** button  on the **Fibers** panel.

A voxel model is created for the chosen group of fibers and added to the list on the **Segmented structure** panel. The name of the structure is copied from the name of the group on the **Fibers** panel.

To create a voxel model based on all the fibers, select the **Base fibers** group and click the **Voxelize tracks** button  on the **Fibers** panel.

The voxel model is created for the chosen group of fibers (**Base fibers**) and added to the list on the **Segmented structure** panel under the name **DTI tractography**.

You can view the model built in the **MPR reconstruction** tab. To open a volume reconstruction, click the **3D** button  on the toolbar. The volume reconstruction will be displayed in the right-hand bottom window.

The work with the structures from the segmented structure list is described in Section 6.4. The surfaces created can be exported or imported. For details on structure export and import, see Section 6.7. The procedures of saving and opening segmentation projects and DTI projects are described in Section 6.11.

### 5.22.7 Saving data in a file

---

Functionality is available in a separate module which is activated in the Pro edition for an extra fee

---

The DICOM Viewer provides an opportunity to save ROI and groups in files with .spj extension. The procedure for saving and opening files is described in Section 6.11. When a file is opened, the data contained in it is added to the data from the **Fibers** panel.

## Chapter 6

# Segmentation

---

Functionality is available in the **Pro** edition

---

Segmentation is the division of an object into its component parts to facilitate research and modelling.

The tasks that segmentation solves:

- researching separate tissue parts with a certain density range. Usually, such parts have a complicated form and are hidden inside other tissues, hence it is impossible or difficult to highlight them with the cutting tools, e.g.: teeth and their roots, tumors, bones, vessels;
- calculating the volume of tissue, such as tumors;
- studying mutual disposition of tissues that cannot be visible simultaneously;
- fusing a segment and a whole model to see its location within the tissue;
- exporting the structure surface for further use, such as 3D-printing;
- importing the objects used in the treatment to simulate their location in the tissues;
- dividing tissues into separate fragments for better visualization.
- cutting tissue by a mask created from a segmented structure.

To solve these problems, the DICOM Viewer allows you to build segmented **structures** both automatically and manually.

The segmentation of tissues is possible in the Volume Reconstruction window and the Multiplanar Reconstructions window. In both modes you work with the same segmented structure (structures), thereby for its/their construction you can use the benefits of both modes, switching between them.

Fig. 6.1 illustrates the segmented root of a tooth highlighted in yellow. Fig. 6.2 illustrates segmented kidneys highlighted in red and blue. The base volume is highlighted with the CLUT so that the bones can be seen best and the other organs are not visible.

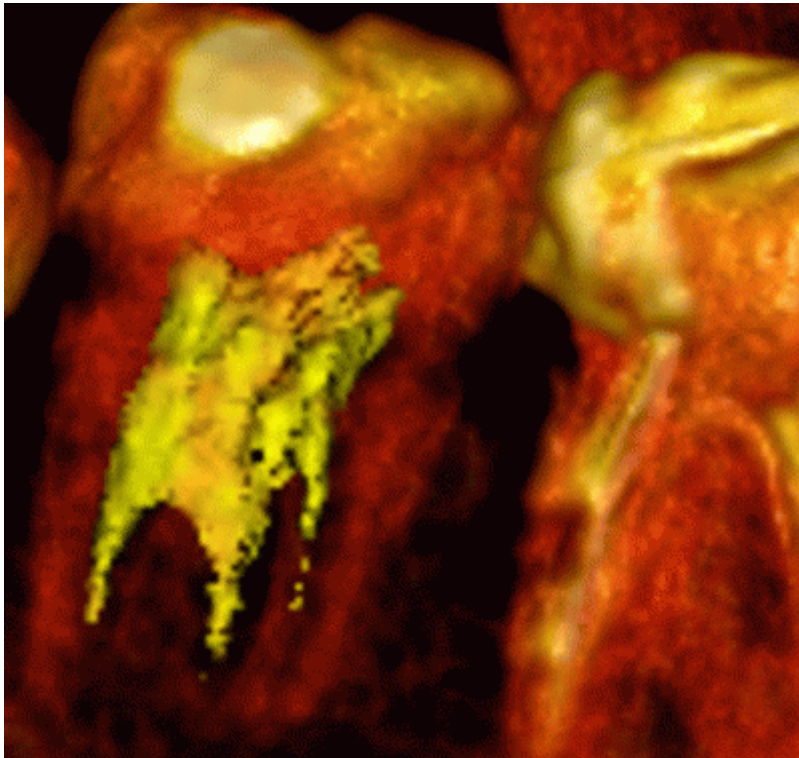

*Figure 6.1: Segmented root of tooth*

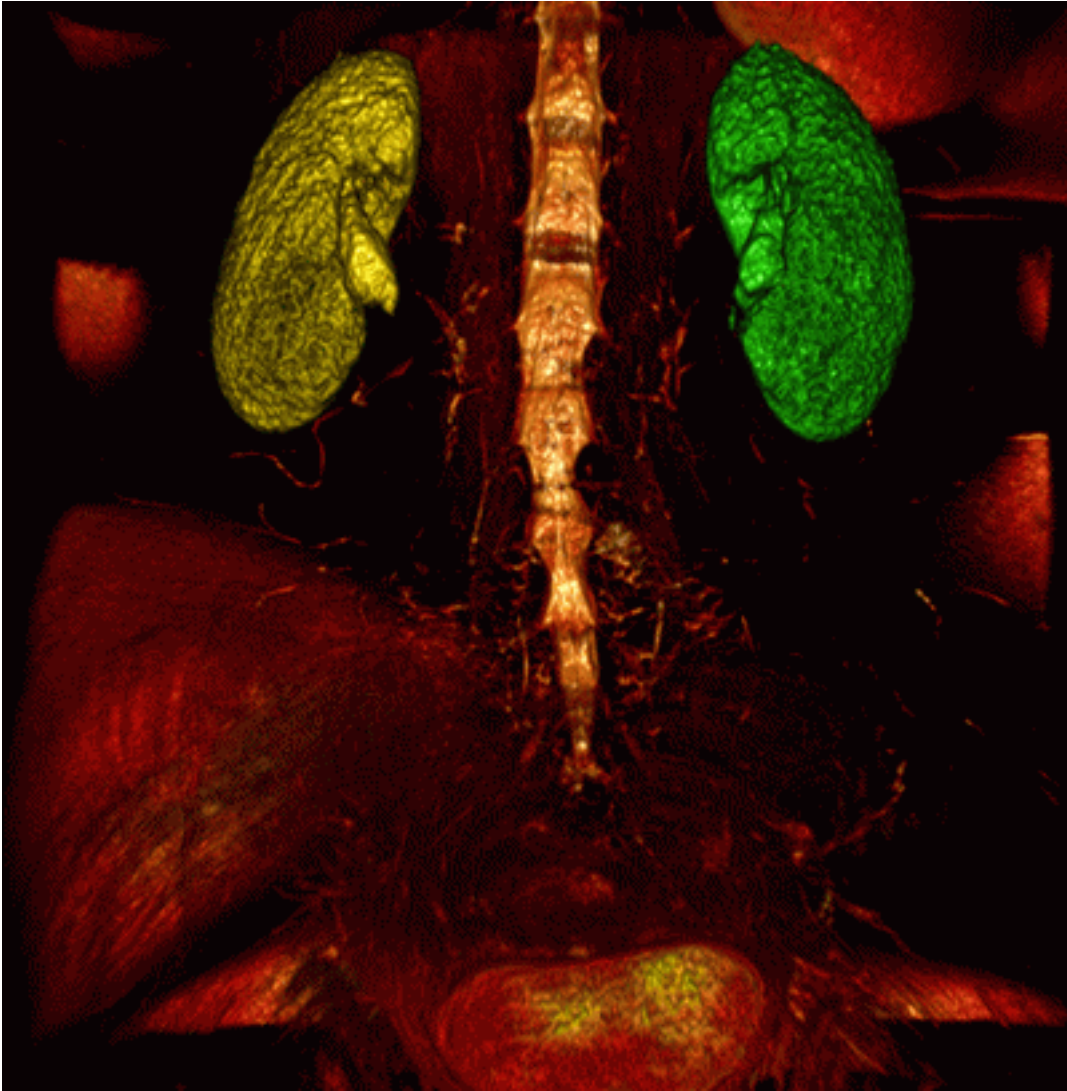

*Figure 6.2: Segmented kidneys*









## 6.1 The Segmented Structures Panel











Functionality is available in the **Pro** edition

To open the segmented structure panel in the **MPR reconstruction** and **Volume reconstruction** tabs, click the **Segmented structure panel**  button on the toolbar.

The segmented structures panel for the **MPR reconstruction** tab is shown in Fig. 6.3. This panel is identical in the **Volume reconstruction** tab, except that the **MPR MPR** nested element is not displayed for the base volume.

The panel contains the Control buttons:

	The <b>Parameters</b> button is used to call up the popup menu for surface creation parameters setup and export/import parameter setup (see Section 6.7).
	The <b>Save segmentation project to file</b> button is used to call up the dialog box for saving a segmentation project in a file (see Section 6.11).
	The <b>Open segmentation project from file</b> button is used to call up the dialog box for opening a segmentation project saved in a file (see Section 6.11).
	The <b>Add a new structure</b> button creates a new structure with an empty mask.
	The <b>Create surface for current segment</b> button creates a surface for a selected structure or for the base volume.
	The <b>Import masks from DICOM RT mask set...</b> button imports a mask of segmented structure from DICOM RT (see Section 6.7.5).
	The <b>Import surface(s)</b> button imports a segmented structure from ply, obj or stl file formats.
	<p>The <b>Duplicate structure/Duplicate mask/Duplicate surface</b> button, depending on the element selected on the segmentation panel, makes a copy of the whole structure, the mask of structure, or the surface in a separate structure (see Section 6.3.1).</p> <p>If the <b>Structure</b> or <b>Base volume</b> option has been selected, the structure <b>Mask</b> and the <b>Surface</b> (when built) are copied to the new structure.</p> <p>If the <b>MPR, Base volume</b>, or structure <b>Mask</b> option has been selected, only the structure mask is copied to the new structure.</p> <p>If the <b>Surface</b> option has been selected, only the surface is copied to the new structure.</p>
	The <b>Restore base volume by mask</b> makes the main volume the same as the selected segmented structure. For the <b>MPR reconstruction</b> tab, the <b>3D view</b> window must be activated.

	The <b>Remove structure/Remove surface</b> button deletes either the whole structure or the surface depending on the option selected on the hierarchical list. When a structure is deleted, a confirmation dialog box pops up.
	The <b>Export</b> button opens export menu for surfaces and masks.
	The <b>Hide all masks/Show all masks</b> button is used to hide/display the masks for the base volume and the structures on the segmentation panel. When all the masks are hidden, the icon is replaced by a crossed out version  .
	The <b>Hide all surfaces/Show all surfaces</b> button is used to hide/display all the surfaces for the base volume and the structures on the segmentation panel. When all the surfaces are hidden, the icon is replaced by a crossed out version  .
	The <b>Optimal view</b> button is used to display all the elements of the list up to the third nesting level and hide all the elements from the third nesting level.
	The <b>Collapse all</b> button collapses all the elements of the list on the segmentation panel except layer items.
	The <b>Expand all</b> button shows all the elements of the list on the segmentation panel.
	The <b>Surface positioning</b> button changes spatial orientation and scale of the imported surface. (only for the 3D reconstruction window). The tool may be activated with the left, right, or middle mouse button. To continue work with the tool, use the button with which the tool was activated. For details on tool control, see Section <a href="#">1.14</a> .



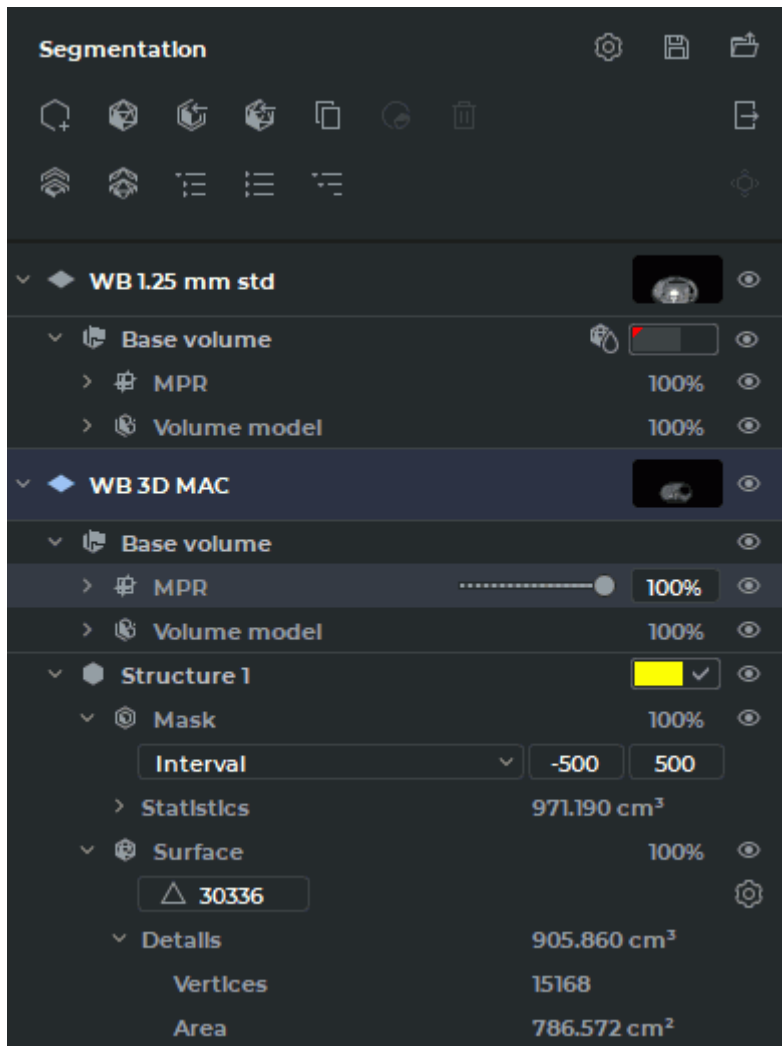





Figure 6.3: The Segmented Structures Panel

The hierarchical list of items on the segmented structures panel consists of the list of layers and the list of segmented structures for each layer.

By default, the optimal view of the list is presented (the items up to the third nesting level are shown). To see all the items, click the **Expand all**  button on the segmented structures panel. To see some particular items, press the arrow on the left-hand side of the name of the item.

In the line referring to the layer, you can see a description of the layer, a thumbnail for the layer series, and a button for customizing visibility  of the layer and all the child items for this layer. The layer includes the base volume and a list of segmented structures. The layer consists of:

- **Base volume.** In this line, the visibility  button for the base volume and all the child items is shown. If a surface has been created for the base volume, then the  symbol is shown in the line. The color of the surface is the same as the color of the initial model.

Alternatively, the user may select the color (see Section 6.4).

The **Base volume** item comprises the following elements:

- **MPR** (shown only in the **MPR reconstruction** tab). It comprises a visibility  button for the item and child items, as well as a field showing the current opacity value for MPR windows. When you mouse over the respective line, a slider is shown. To change the opacity value, move the slider or enter the required numeric value in a percentage.

The **MPR** comprises the following items:

- \* a CLUT settings control element for the **MPR reconstruction** tab;
- \* **Statistics**. This item provides for the results of base volume measurements. Besides the visible voxel volume, the minimum, maximum, and average intensity values are shown, as well as the standard intensity value deviation. When tissues are cut off with the **Clipping Box** tool, only the statistics for the base volume is affected. It has no impact on the statistics for segmented structures;
- **Volume model**. It comprises a visibility  button for the base volume, as well as a field showing the current opacity value for the **3D view** window and the **Volume reconstruction** tab. When you mouse over the respective line, a slider is shown. To change the opacity value, move the slider or enter the required numeric value in a percentage;

The **Volume model** comprises the following items:

- \* a CLUT settings control element for the **3D view** window and the **Volume reconstruction** tab;
- \* **Statistics**. This item provides for the results of base volume measurements. Besides the visible voxel volume, the minimum, maximum, and average intensity values are shown, as well as the standard intensity value deviation. When tissues are cut off with the **Clipping Box** tool, only the statistics for the base volume is affected. It has no impact on the statistics for segmented structures;
- **Surface** (if created). It comprises a visibility  button for the surface, as well as a field showing the current opacity value. When you mouse over the respective line, a slider is shown. To change the opacity value, move the slider or enter the required numeric value in a percentage.

The **Surface** comprises the following items:

- \* a field for changing the number of triangles forming the surface;
- \* the **Change surface creation parameters**  button used to call up the dialog box for customizing the surface parameters;
- \* **Details**. This item provides the information about the volume of voxels around which the surface was built, the number of vertices and the surface area.

In the **Structure** line for the segmented structure, you see the name of the structure, color control elements, and a visibility  button for the structure and its child items. The **Structure** comprises the following items:

- **Mask**. This element is used for control of the segmented structure voxel model, and its structure is similar to the **Volume model** element. It comprises a visibility  button for the structure mask. When you mouse over the respective line, you see the current

structure mask opacity value. To change the opacity value, move the slider or enter the required numeric value in a percentage.

- **Surface.** This element is used for customizing the surface settings, and its structure is similar to the **Surface** element for the layer.

## 6.2 The Mask

### 6.2.1 Creating a new structure and mask

Functionality is available in the **Pro** edition

1. Click the **Add a new structure**  button. The dialog shown in Fig. 6.4 appears.

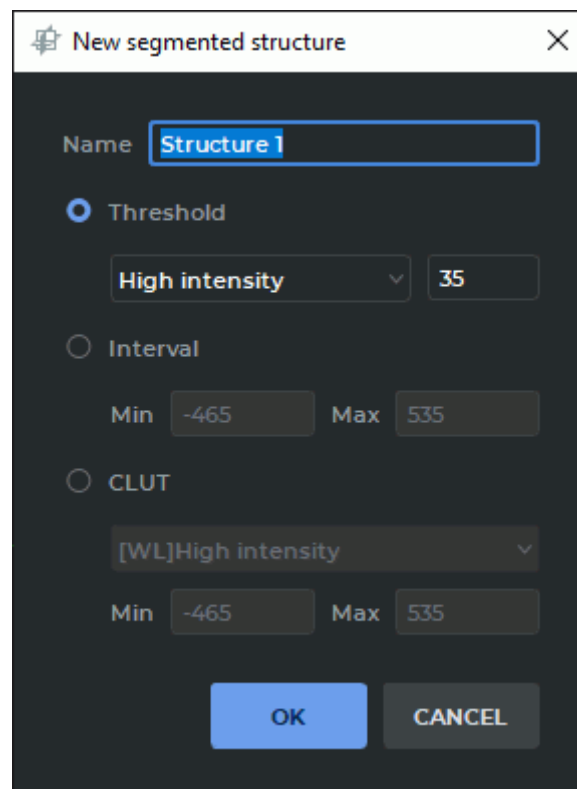

Figure 6.4: Set mask for a new structure

2. Enter the name of the new structure in the **Name** field. By default, the name of the structure is automatically generated by the <Structure X> template, where X is the counter with the increment of one point. The first value is 1.
3. Set the tissue density values for the mask. You can do it in one of the three ways:

- using the **Threshold** mode. In this mode the mask is set for the tissue whose density is greater or less than the specified threshold value. To set the mask for the tissue with a density less than the threshold, select the **Low intensity** setting, and vice versa. Set the threshold;
  - using the **Interval** mode. In this mode the mask is set for the tissue whose density is in the range from minimum to maximum;
  - using color tables. In this mode the mask is set for the tissue displayed for the selected color table.
4. Click **OK** to create a new structure and mask or **CANCEL** to cancel.



## 6.2.2 Changing the structure mask using CLUTs

---

Functionality is available in the **Pro** edition

---

You can change the [mask](#) of the current structure in several ways:

1. Using the **Adjust W/L** tool:
  - (a) Select the target structure on the panel of segmented structures.
  - (b) Click the **Adjust W/L**  button on the toolbar.
  - (c) Change the window width and level for the editing mask (see Section 2.17). The green editing mask changes in real time in the MPR window.
2. Selecting the color table from the dropdown list (see Section 2.22.1) or with the **Custom W/L**  tool (see Section 2.17).
3. For the properties tree on the Segmented structure panel (Figure 6.5):
  - (a) Unfold the list of the segmented structure properties.
  - (b) In the drop-down list, select the editing mask mode or the color table you need:
    - The **High intensity** and **Low intensity** mode provides the editing mask for tissues whose density is above or below the threshold value.
    - The **Interval** mode provides the editing mask for tissues whose density is within the set value range.
    - The **CLUT** mode provides the editing mask for the tissues displayed for the chosen color table.
  - (c) To change the interval or the density threshold, click with the left mouse button on the values (see the red box in Figure 6.5). Provide the values you need and press **Enter** key on the keyboard.

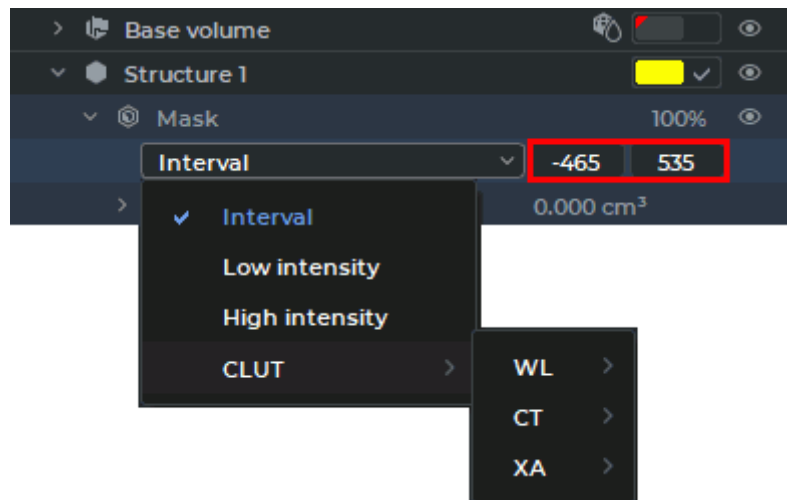

Figure 6.5: Editing the mask

The editing mask parameters (the color table, the intensity threshold value and the interval) are changed for each segmented structure separately. The color table type and the editing mask mode for the segmented structure selected is shown on the visualization setup panel.

4. For the Volume Reconstruction window only: using the **Set mask** tool (see Section 6.2.4).

You can change the editing mask visibility for the current structure using the editing mask setup panel (see Section 6.2.3).

### 6.2.3 The Editing mask

Functionality is available in the **Pro** edition

The **editing mask** is a pattern beyond which the structure mask is not visible.

The editing mask is not visible in the volume reconstruction window, and it is displayed in green in the MPR window. If necessary, the editing mask can be inverted. In this case, the tissues not under the editing mask are displayed in green. To invert the editing mask, set the flag **Invert edit mask on MPR** (see Section 16.7.3).

The editing mask can be changed at any time (see Section 6.2.2). If the editing mask is reduced and the structure goes beyond the editing mask, then this part of the structure becomes invisible and is not taken into account in the calculations. However, it is not removed and when the editing mask is increased, it becomes visible again.

You can change the editing mask visibility for the current structure using the editing mask setup panel (Fig. 6.6). The panel is placed at the bottom of the segmented structures panel and is only available in the **MPR reconstruction** tab.

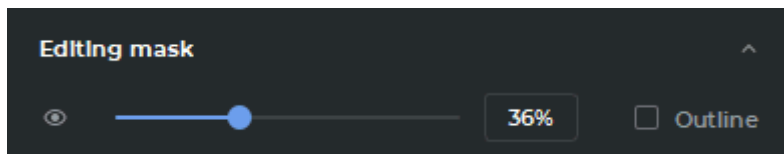

Figure 6.6: Editing mask panel

There are two ways to change the visibility of the editing mask:



- move the slider or roll the mouse wheel while the cursor is placed on the slider;
- enter the opacity value in the field on the right-hand side of the slider.

The editing mask opacity value is expressed as a percentage.

To see the outline of the editing mask, check the **Outline** box.

To conceal the editing mask, click the **Hide mask**  button on the editing mask setup panel. To display the editing mask, click the **Show mask**  button.

The **Hide mask**  button is unavailable if at least one tool for segmentation or volume editing has been activated.

To minimize the editing mask setup panel, click the **Hide**  button. To display the hidden panel, click the **Show**  button.

## 6.2.4 Set Mask Tool

---

Functionality is available in the **Pro** edition

---

The tool is only available for the **Volume reconstruction** tab. To set a structure as a mask for another structure or base volume, proceed as follows:

1. On the list of structures, select the structure (base volume) for which you want to change the mask.
2. Click on the **Set Mask**  button. The dialog shown in Fig. 6.7 will be displayed.
3. On the list of structures, select the structure (base volume) you want to set as the mask.
4. Click **OK** to confirm or **CANCEL** to cancel the action.

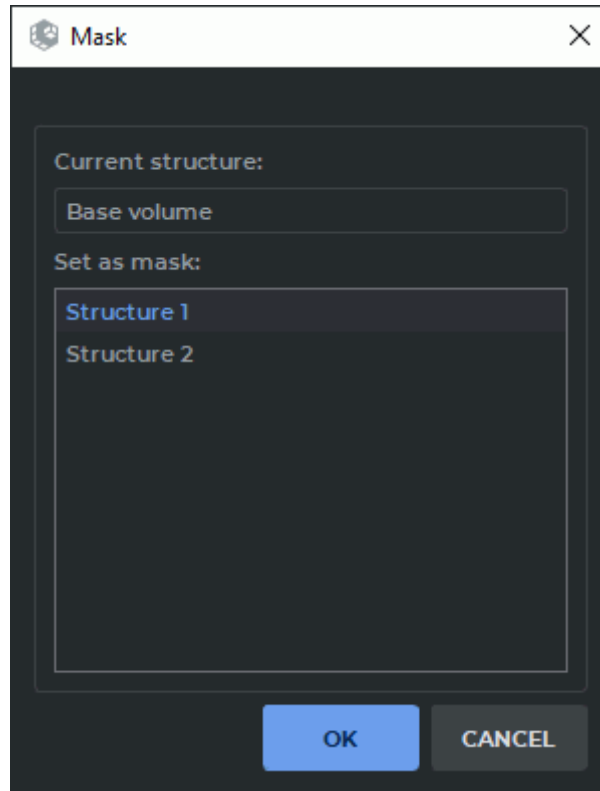

Figure 6.7: Select mask dialog

## 6.3 Creating segmented structure



### 6.3.1 Creating a structure by copying

---

Functionality is available in the **Pro** edition

---

When you create a structure by copying, a new structure is created. Depending on the selected element, the current structure is copied to the new structure as a whole (the mask of the current structure and the surface, if it was built), only the mask of the structure or only the surface. To create a structure:

1. Open the segmentation panel by clicking the **Segmented structure panel**  button.
2. Choose the base volume or the structure created earlier as the initial volume.
3. Click the **Duplicate structure**  button on the segmented structure panel or place the cursor over the structure, click the right mouse button and choose the **Duplicate structure** point in the right-click menu. Depending on the option selected, the whole structure or just the surface is copied to a separate structure.





If the **Structure** or **Base volume** option has been selected, the structure mask and the surface (when built) are copied to the new structure.  
 If the **MPR**, **Volume model**, or **Mask** option has been selected, only the structure mask is copied to the new structure.  
 If the **Surface** option has been selected, only the surface is copied to the new structure.

### 6.3.2 Creating a Structure with a Empty Mask

Functionality is available in the **Pro** edition



To create a structure with a empty mask, proceed as follows:

1. Open the segmentation panel by clicking the **Segmented structure panel**  button.
2. Click the **Add a new segmentation structure**  button. Set the mask in the dialog that opens (see Section 6.2.1). A structure is created with an empty structure mask and an editing mask with the specified parameters.
3. Fill out the structure using volume editing tools (see Section 6.8).

## 6.4 Actions with structure

Functionality is available in the **Pro** edition

The DICOM Viewer allows you to perform the following actions with structures:

- Renaming. Can be done in two ways:
  - double left-click the structure name. Enter a new name and press the **Enter** key on the keyboard;
  - place the cursor over the structure, click the right mouse button and choose the **Rename structure** point in the right-click menu. Enter a new name and press the **Enter** key on the keyboard.
- Disabling visibility. The visibility button  (Fig. 6.8) turn off visibility of structure mask and surface for this structure. This action is also available for the base volume. The button for the invisible element appears as .

If you change the visibility status for any element from the list, it will not affect the status of the visibility buttons of its parent elements. If you disable visibility for the parent element, the child elements will also become invisible. In this case, the visibility buttons for the child elements that were not switched off by the user will appear as .

When projects are saved, the visibility status is also saved on the segmentation list for:



- base volume;
- MPR;
- layers;
- structures.

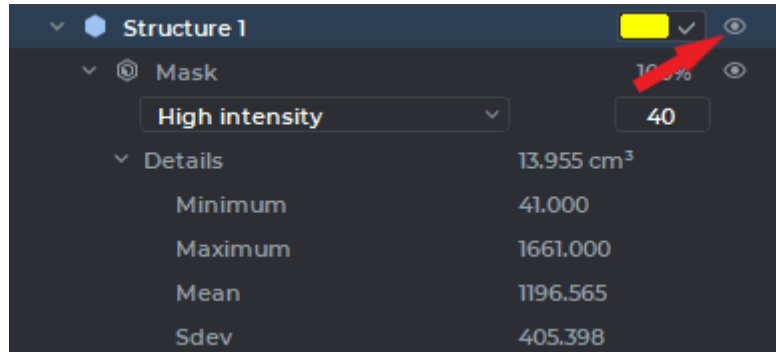



Figure 6.8: Button to change the visibility of mask and structure surface

- Color change. To do this:
  1. To set the user's color, check the box in the line representing the structure (see the red arrow in Fig. 6.9). To change the color, click the colored rectangle in the line representing the structure and choose the color you need.
  2. To use the color of the initial model, uncheck the box. The color of the mask and the surface of the structure takes on the color of the initial model.
- Deletion. Can be accomplished in two ways:
  - on the segmented structure panel, select the surface you want to delete. Click the **Remove structure/Remove surface**  button on the segmented structure panel;
  - place the cursor over the structure, click the right mouse button and choose the **Remove structure/Remove surface** point in the right-click menu. In the dialog box that pops up, click **REMOVE** to delete the structure or **CANCEL** to cancel.

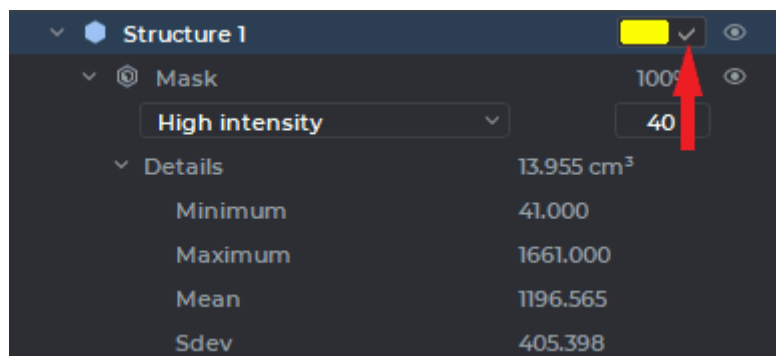

Figure 6.9: Custom color check box

If you want the DICOM Viewer to always delete structure without this confirmation, check the box **Don't show this dialog again**. If you want the DICOM Viewer to show the confirmation dialog, check the box **Confirm on the structure removing** (see Section 16.7.3).

## 6.5 Building surface

---

Functionality is available in the **Pro** edition

---

The DICOM Viewer allows you to create a surface for segmented structures and base volume in the Volume Reconstruction window and in the Multiplanar Reconstruction window. In multiphase series, you can build a surface for base volume of the each phase.

**Attention! Surfaces transparency is not supported if:**





- a CPU has been chosen as the render device;
- the software was installed on macOS lower operating system than 10.15.



**On macOS 10.15 and later, it is recommended to use a visualization device that supports Metal polygonal and voxel rendering. The settings are described in Section 16.7.3.**

On the segmented structures list, select the base volume or the structure for which you want to build a surface.

To customize the parameters used by default when building a surface, click the **Parameters**  button on the segmented structures panel and select the **Default surface parameters...** option. In the dialog box that pops up (Fig. 6.11), provide the required default parameters for building surfaces.

To build a surface, click on the **Create surface for current structure**  button on the segmented structures list. The surface is built according to the current settings.

To customize the parameters for each of the surfaces built, unfold the surface properties tree on the segmented structure panel (see Fig. 6.10). Click the  **Change surface creation parameters** button.

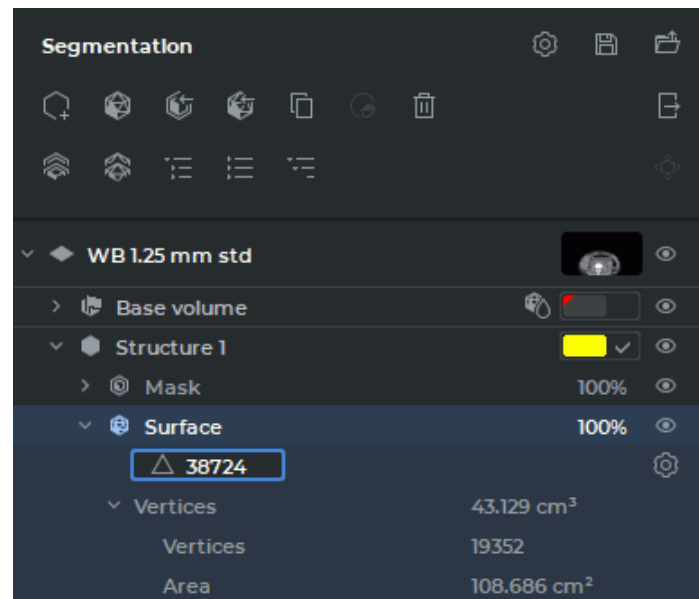

Figure 6.10: Surface parameters

Set the surface parameters in the dialog box that pops up (see Fig. 6.11).

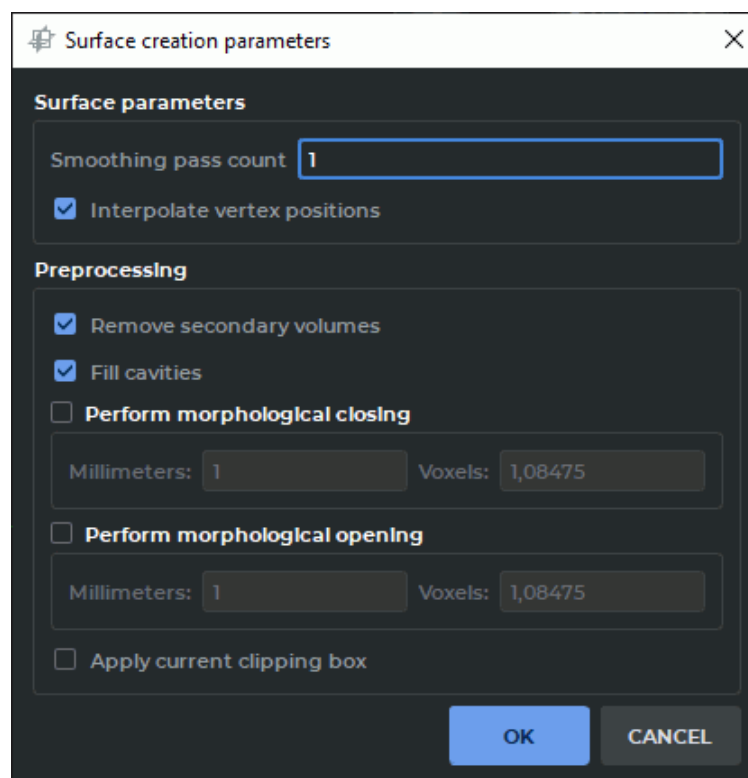





Figure 6.11: Surface creation parameters

- The smoothness of the surface is defined by the **Smoothing pass count** parameter. With this parameter set at zero value, the form of the surface is as close as possible to the

structure. With an increase in the value, the surface roughness disappears.

- If the **Interpolate vertex positions** box is checked (checked by default), the surface is smoothed at the border of the volume.
- To create the surface only for the largest structure, check the **Remove secondary volumes** box.
- To fill the cavities and hollows, check the **Fill cavities** box. As an alternative, you can use the  **Fill** tool (see Section 3.8.7).
- To fill small cavities, check the **Perform morphological closing** box. As an alternative, you can use the  **Remove holes (closing)** tool (see Section 3.8.7). The volume of the model is first increased and then decreased by the operation radius provided (in millimeters or voxels). The shape of the surface and the external dimensions are not changed.
- To eliminate visual surface defects, check the **Perform morphological opening** box. As an alternative, you can use the  **Remove noise (opening)** tool (see Section 3.8.7). The volume of the model is first decreased and then increased by the operation radius provided (in millimeters or voxels). The shape of the surface and the external dimensions are not changed.
- If the **Apply current clipping box** box is checked, then the surface is built only for that part of the structure which is inside the cube.

To apply the settings, click **OK**. To cancel, click **CANCEL**.

When the segmentation project is saved, all the surface building parameters are saved in the file. For details on saving projects, see Section 6.11.

The surface is represented by a polygon model made of triangles.

The program automatically determines the maximum possible number of triangles required for creating a surface imitating the volume surface. The number of the triangles making up the surface may be changed on the Segmented structure panel.

To change the number of the triangles making up the surface, unfold the surface properties tree on the Segmented structure panel (Figure 6.10).

Double-click with the left mouse button on the value in the field with a triangle icon. Change the value showing the number of triangles and press **Enter** key on the keyboard.

If the number of triangles entered is too small or too large to build a surface, the DICOM Viewer will use the value from the permitted range which is the closest to the value provided by the user.

If the entered value equals 0, the program will build a surface using the maximum possible number of triangles which will be shown in the field with a triangle icon.

If visibility for this structure or surface is disabled, you cannot use the cutting tools, as well as the **Segmentation from point by mask**, **Region growing** and **Vessel tree segmentation** tools.

You can only edit hidden structures with intelligent volume editing tools, such as **Grow (dilation)**, **Shrink (erosion)**, **Remove noise (opening)**, **Remove holes (closing)** (for details see Section 3.8.7), as well as with the **Union**, **Subtract**, **Subtract dilated**, and **Intersect** tools (for details see Section 6.9). In this case, the following message pops up: «**The target structure**

is hidden. **Are you sure you want to apply the operation to it?»** Click **Yes** to proceed or **No** to cancel.

## 6.6 Copying a Surface

Functionality is available in the **Pro** edition

The DICOM Viewer provides for copying segmented structure surfaces in the **MPR Reconstruction** and **Volume Reconstruction** windows. You can copy a segmented structure surface:

- in one study series;
- in a merged study series.

To make a copy of a segmented structure surface in a single study series, proceed as follows:

1. On the segmented structure panel, select the surface you want to copy.
2. Click the **Duplicate surface**  button on the segmented structure panel or place the cursor over the structure, click the right mouse button and choose the **Duplicate surface** point in the right-click menu.

On the segmented structure list, you will see a copy of the surface with a «*surface copy*» note. The name of the surface copy, as well as the name of any structure without a structure mask, is shown in italics.

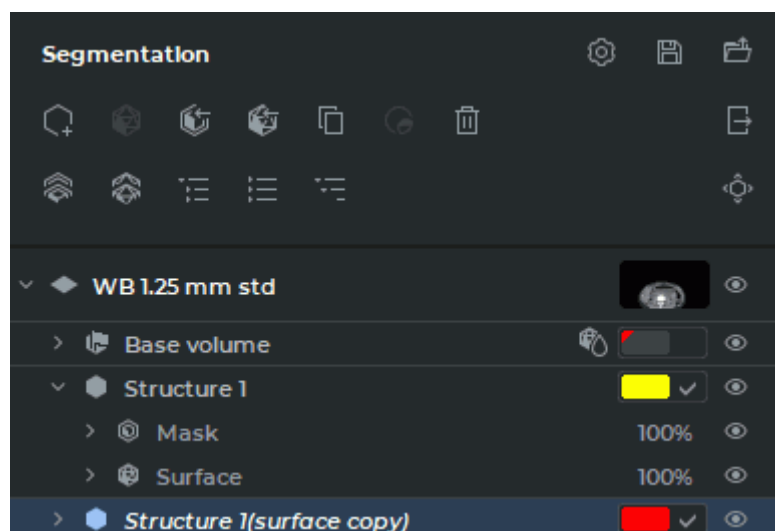



Figure 6.12: Surface copy

To make a copy of a segmented structure surface in a merged series, proceed as follows:

1. On the segmented structure panel, select the surface you want to copy.
2. Click the **Duplicate surface**  button on the segmented structure panel or place the cursor over the structure, click the right mouse button and choose the **Duplicate surface** point in the right-click menu.
3. In the **Layer selection** (see Fig. 6.13), select from the drop-down list the layer where you want to place the surface copy.

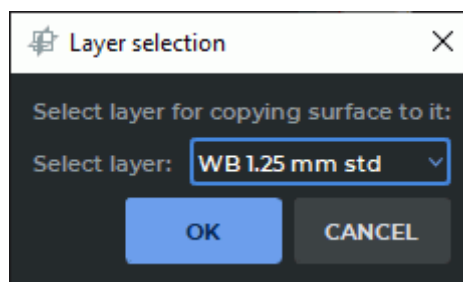



Figure 6.13: Layer selection dialog box

4. Click **OK** to copy the surface to the selected layer or **CANCEL** to cancel.

On the segmented structure panel for the layer selected, you will see a copy of the surface with a «*surface copy*» note. The name of the surface copy, as well as the name of any structure without a structure mask, is shown in italics.

To move the copied surface manually, activate the tool **Surface positioning**  by clicking the left/right/middle mouse button. To continue work with this tool, use the button with which the tool was activated. To learn more about tool control, see Section 1.14. Move the surface on the plane of the screen, holding the mouse button with which the tool was activated.

To scale the surface, move the mouse up and down while holding the **Ctrl** key and the button with which the tool was activated.

To rotate the surface around its center, move the mouse while holding the **Alt** key and the button with which the tool was activated.

To create a segmented structure for a surface, place the cursor over the copy of the surface, click the right mouse button and choose the **Create mask by surface** point in the right-click menu.

The things you can do with the surfaces and structures on the segmented structure list are described in Section 6.4. The surfaces you have built or copied may be exported or imported. For details on export and import of surfaces and structures, see Section 6.7. The procedures of saving and opening segmentation and DTI projects are described in Section 6.11.

## 6.7 Import and Export

### 6.7.1 Export surface

Functionality is available in the **Pro** edition

To customize the parameters used by default when exporting a surface, click the **Parameters**  button on the segmented structures panel and select the **Export/Import parameters...** option. In the dialog box that pops up (Fig. 6.14), provide the required default parameters for exporting surfaces.

- to move the reference point (the point relative to which the model can be deformed in the Vector graphics editors) to the geometrical center of the surface, in the dialog box check the **Center surface** box. The option is disabled by default;
- to use the patient's coordinates when exporting, check the **Import and export surfaces using patient coordinates** box. Check box is set by default;

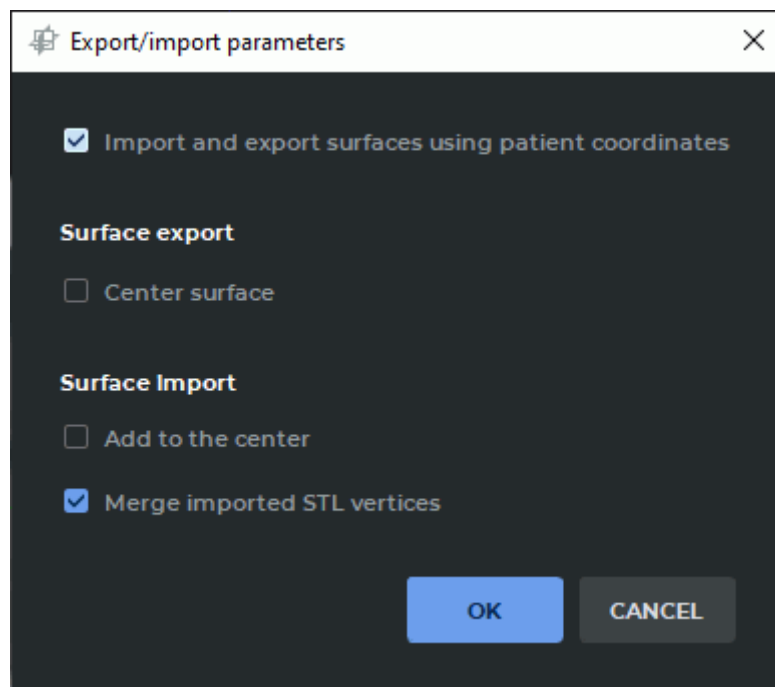



Figure 6.14: Surface export and import parameters

To apply the settings, click **OK**. To cancel, click **CANCEL**.

To export a segmented structure surface, proceed as follows:

1. On the segmented structures panel, select the surface to be exported.
2. Call up the popup menu with the export options in one of the following ways:

- click the **Export**  button on the segmented structures panel and choose the type of export from the popup menu;
- mouse over the structure on the list, right-click and choose the **Export** option from the right-click menu. Then select the type of export.

There are three options for exporting a surface:

- **Export selected surface.** Only the surface that is currently chosen is exported. It may be exported in *.ply*, *.obj*, *.stl* or *.glb* format. In the dialog box that appears, select the file type and save the surface;
- **Export all visible surfaces.** All the visible surfaces for which visibility in the segmented structures panel is enabled are exported. They may only be exported in *.glb* format;
- **Export all surfaces.** All the surfaces on the segmented structure panel are exported. They may only be exported in *.glb* format.

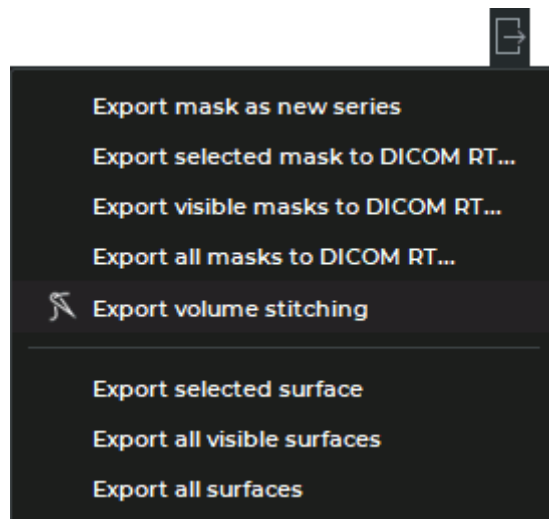

Figure 6.15: Export menu

If export is performed for several layers, the hierarchy is retained: layers (with the name of the respective series) occupy the first level, while the second level is occupied by surfaces. When surfaces are exported from the same layer, only one hierarchy level (surfaces) is retained.

The name, the color of the apices and the transparency are retained for each surface. When several surfaces are exported, their relative position which is the same as the relative position in the DICOM Viewer at the time of export is retained.



You need to be aware that when the surface is printed by a 3D printer, errors may occur for the following reasons:



1. The surface accuracy depends on the voxel size; the margin of error cannot be higher than the voxel size.
2. The boundaries of the structure mask for which the surface is created depend on the color palette for the initial volume. If a wrong palette is chosen, some tissues that are needed may become invisible, while some negligible tissues may become visible.
3. The boundaries between tissues characterized by different density values may be blurred because of the physical principles behind the tissue scanning technology. The margin of error may be up to several voxels.
4. The surface accuracy is subject to antialiasing and depends on the triangles count.

## 6.7.2 Import surface

---

Functionality is available in the **Pro** edition

---

To customize the parameters used by default when importing a surface, click the **Parameters**  button on the segmented structures panel and select the **Export/Import parameters...** option. In the dialog box that pops up (Fig. 6.16), check the following boxes:

- to use the patient's coordinates, check the **Import and export surfaces using patient coordinates** box;
- to align the centers of the imported surface and the model when importing, check the **Add to the center** box;
- to merge the vertices of the triangles when importing a surface in (stl) format, check the **Merge imported STL vertices** box. This box is checked by default.

Click **OK** to apply the settings or **CANCEL** to cancel.

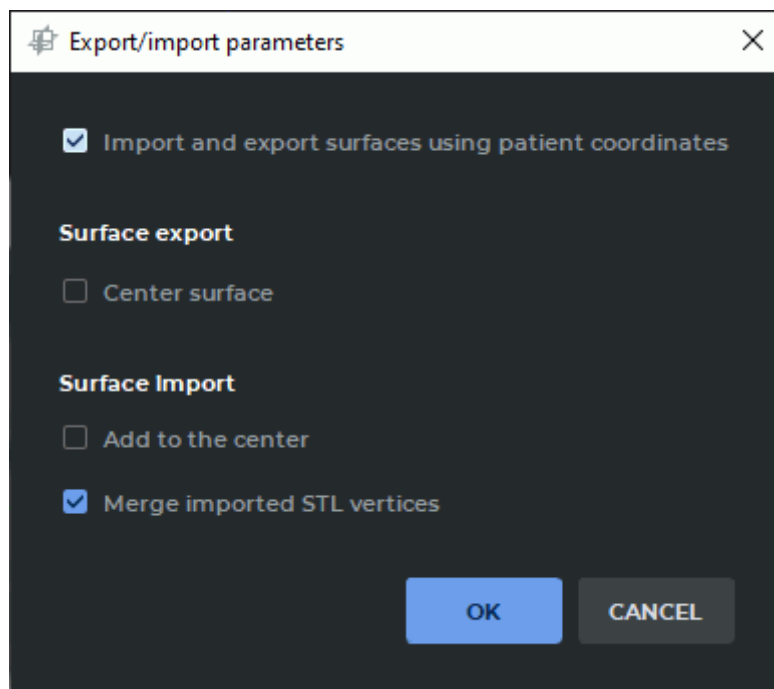



Figure 6.16: Surface export and import parameters

There are two ways to import surfaces:

- click the **Import surface(s)**  button. In the dialog box that pops up, select the files and click **Open**;
- mouse over the structure on the list, right-click and choose the **Import->Import surface(s)...** option from the right-click menu. In the dialog box that pops up, select the files and click **Open**.

The name of the imported surface, as well as the name of any structure without a structure mask, is shown in italics. In Figure 6.17 you see an imported surface *Surface\_example-1*. You cannot change the number of triangles for the imported surface.

To move the imported surface manually, activate the tool **Surface positioning**  by clicking the left/right/middle mouse button. To continue work with this tool, use the button with which the tool was activated. To learn more about tool control, see Section 1.14. Move the surface on the plane of the screen, holding the mouse button with which the tool was activated.

To scale the surface, move the mouse up and down while holding the **Ctrl** key and the button with which the tool was activated.

To rotate the surface around its center, move the mouse while holding the **Alt** key and the button with which the tool was activated.

To create a segmented structure for a surface, place the cursor over the copy of the surface, click the right mouse button and choose the **Create mask by surface** point in the right-click menu.

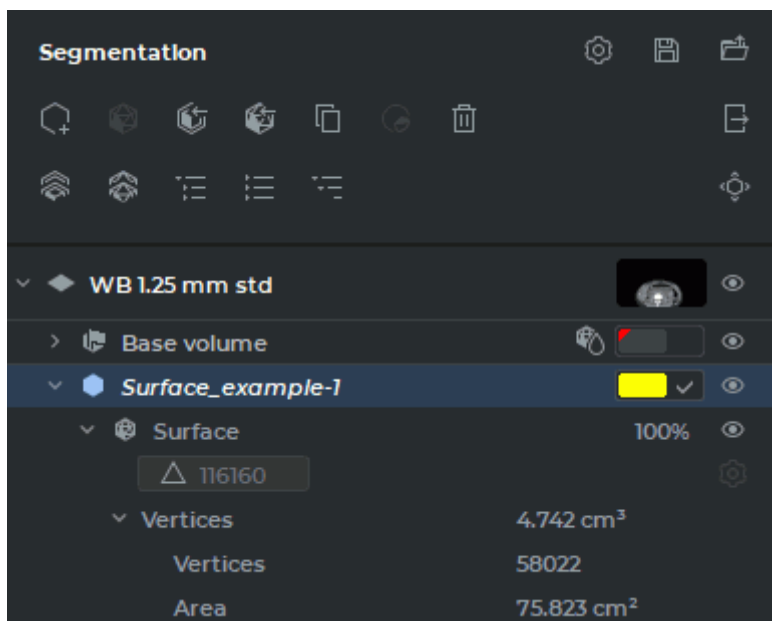



Figure 6.17: Imported surface

### 6.7.3 Export a structure to the current study

Functionality is available in a separate module which is activated in the Pro edition for an extra fee

The DICOM Viewer allows for exporting masks of segmented structures to the current study as a new series or as DICOM RT Structure Set IOD.

To export a structure mask to the current study as a new series, proceed as follows:

1. Select the structure mask you need on the Segmented structure panel.
2. Export the structure mask to the current study in one of the following ways:
  - click the **Export**  button on the segmented structures panel and choose the **Export mask as new series** option from the popup menu;
  - mouse over the structure on the list, whose mask you want to export right-click and choose the **Export** option from the right-click menu. Then select the **Export mask as new series** option.

The exported structure mask will be saved in the local storage as a new series of the current study. A thumbnail for the new series will be added to the series panel.

The exported structure mask can be opened in the flat image viewer, volume reconstruction, or MPR reconstruction tab.

The position of slices in a new series is in compliance with the window that was selected when the **Export mask as new series** command was given. If a **3D view** window is selected, then the position of the planes will be in compliance with the position of the slices in the **Axial plane** window.

## 6.7.4 Export a structure to DICOM RT

Functionality is available in a separate module which is activated in the Pro edition for an extra fee

To export a structure mask of the segmented structure to DICOM RT, proceed as follows:

1. On the segmented structures panel, select the structure whose mask to be exported to DICOM RT.
2. Call up the popup menu with the export options (Fig. 6.18) in one of the following ways:
  - click the **Export**  button on the segmented structures panel and choose the type of export to DICOM RT from the popup menu;
  - mouse over the structure on the list whose mask you want to export, right-click and choose the **Export** option from the right-click menu. Then select the type of export to DICOM RT.

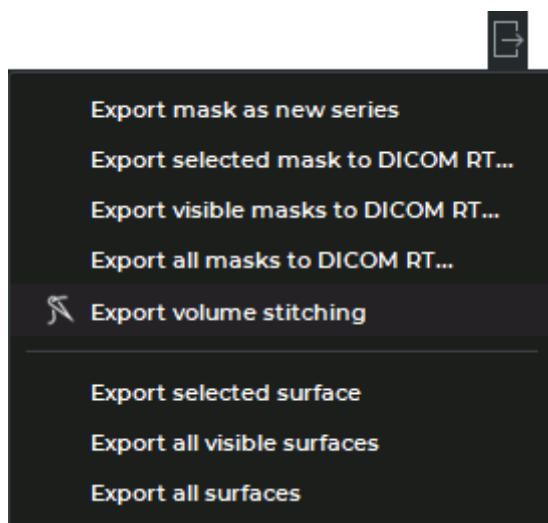

Figure 6.18: Export drop-down menu

There are three ways to export a mask of structure to DICOM RT:

- **Export selected mask to DICOM RT....** Only the mask of the currently selected structure is exported;
- **Export visible masks to DICOM RT....** All the visible masks of structures from the segmented structures panel (for which the visibility button has been activated) are exported;
- **Export all masks to DICOM RT....** All the masks of structures from the segmented structures panel are exported.

In the **Export to DICOM RT** (Fig. 6.19) dialog box that pops up, add a description of the exported RTSTRUCT series. The default series description is «Segmentation».

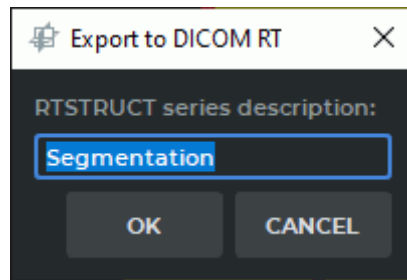

Figure 6.19: Export to DICOM RT

Click **OK** button to export mask of structure or **CANCEL** to cancel.

The exported mask of structure will be saved in the local storage as a new series with RTSTRUCT modality. A thumbnail for the new series will be added to the series panel.

If a series has several phases, the mask of structure will only be exported for the current phase. If no mask was exported during the export procedure (e.g. no voxels are visible under the editing mask), an error message will pop up.

### 6.7.5 Importing a Structure from DICOM RT

Functionality is available in a separate module which is activated in the Pro edition for an extra fee

There are two ways to import a mask of segmented structure from DICOM RT:

- click the **Import masks from DICOM RT...**  button on the segmented structures panel;
- mouse over the structure on the list, whose mask you want to import right-click and choose the **Import** option from the right-click menu. Then select the **Import masks from DICOM RT...** option.

In the **Import from DICOM RT** dialog box (Figure 6.20), select an RTSTRUCT modality series to import.

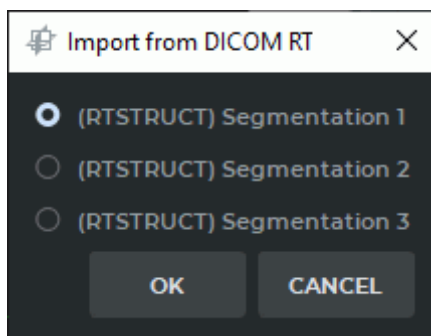

Figure 6.20: Import from DICOM RT

Click **OK** button to import structure mask or **CANCEL** to cancel.

In the **Structures to import** section of the dialog box (Figure 6.21), check the box next to the structure whose mask you want to import. To import all the masks of the structures from the list, check the upper box. By default, the boxes are not checked.

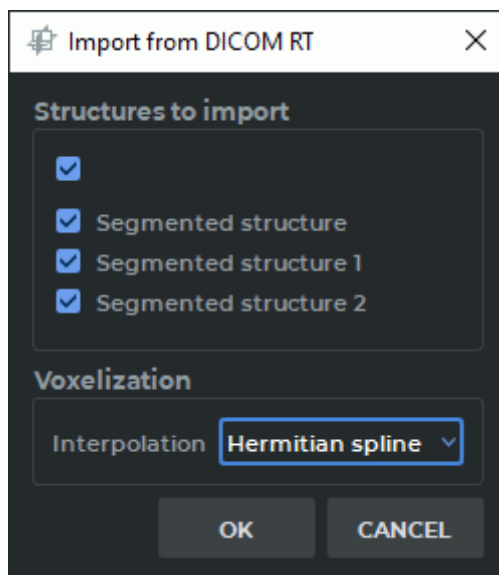

Figure 6.21: Structure selection dialog

Click **OK** to import structure mask or **CANCEL** to cancel.

## 6.8 Changing the structure mask with segmentation tools

---

Functionality is available in the **Pro** edition

---

When working with segmented structures, pay attention to which structure or volume is selected. All the editing operations are performed with a selected visible structure mask or



volume. If the visibility button  (Fig. 6.22) hides the visibility of mask and surface for this structure editing is not possible because the cutting tools (**Segmentation from point by mask**, **Region growing** and **Vessel tree segmentation**) are deactivated.



Figure 6.22: Button to change the visibility of all masks and structure surfaces

Invisible structures can be edited with smart volume editing tools, such as **Grow (dilation)**, **Shrink (erosion)**, **Remove noise (opening)**, **Remove holes (closing)** (for details see Section 3.8.7), as well as **Union**, **Subtract**, **Subtract dilated**, and **Intersect** tools see Section 6.9.

In this case, the dialog box is displayed: **The target structure is hidden. Are you sure you want to apply the operation to it?** Click **Yes** to proceed or **No** to cancel.

If the volume model is open (see Section 5.21), then the created structure appears simultaneously on the model. This causes additional load on the processor. If you want to reduce the load, click the arrow on the right side of the **Growing Region**  button and uncheck the **Interactive 3D Update** item. After this, the structure on the volume model will be updated after the next structure creation phase is completed.

If a base volume or mask of segmented structure is edited, the respective surfaces are automatically rebuilt.

To edit a structure mask, use specialized tools (described below) and volume editing tools:

- **Polygon Cut** (see Section 3.8.1);
- **Inverse Polygon Cut** (see Section 3.8.2);
- **Delete Area** (see Section 3.8.3);
- **Delete All Areas except Selected Area** (see Section 3.8.4);
- **Brush Cut** (see Section 3.8.6);
- **Brush Restore** (see Section 3.8.6). The use of the tool is possible only if a part of the structure is already created;
- **Contour segmentation** (see Section 6.10);
- **Grow (dilation)** (see Section 3.8.7);
- **Srink (erosion)** (see Section 3.8.7);

- **Remove noise (opening)** (see Section 3.8.7);
- **Remove holes (closing)** (see Section 3.8.7);
- **Multi-segment growing** (see Section 3.8.7);
- **Fill** (see Section 3.8.7).
- **Cut Invisible Volume** (see Section 6.9);
- **Vessels Tree Segmentation** (see Section 6.8.4);
- **Segmented structures regions growing** (see Section 6.8.7);
- **Union** (see Section 6.9);
- **Subtract** (see Section 6.9);
- **Subtract dilated** (see Section 6.9);
- **Intersect** (see Section 6.9).



## 6.8.1 Tools for automatic segmented structure mask filling

---

Functionality is available in the **Pro** edition

---



The **Segmentation from point by mask** tool allows you to create a structure mask for a bound area. It is necessary that the structure mask for this area does not touch the structure masks of the neighboring areas. To create a structure mask:

1. Activate the **Segmentation from point by mask**  tool by clicking the left/right/middle mouse button. To continue work with this tool, use the button with which the tool was activated. To learn more about tool control, see Section 1.14.
2. Click on the bound area.
3. If the structure mask was created for a larger area than required, undo the action by clicking the **Undo**  button. Change the window width and level so that the editing mask for this area is not in contact with the masks of the neighboring areas and create the mask again.

If it is impossible to get a bound area completely separated from other tissues, then if you use the tool **Segmentation from point by mask**, there will be leaks (segmentation beyond the required area). To create a segment quickly and with minimal leaks, use the **Region growing**  tool:

1. Activate the **Region growing** tool by clicking the left/right/middle mouse button. To continue work with this tool, use the button with which the tool was activated. To learn more about tool control, see Section 1.14. The tool modes are described in Section 6.8.3.



2. Select the point on the editing mask roughly in the center of the region you want to segment.
3. Move the cursor in any direction, holding the mouse button. The structure mask will grow. The growth occurs faster in those directions in which the curvature of the surface is less (in thin sections the growth is slower to avoid leaks). The direction of the cursor movement does not matter, the distance from the starting point of the movement is important. When the cursor moves in the opposite direction, the structure mask does not decrease.
4. If the structure is completely created or if any further growth leads to leaks, stop the growing process by releasing the left mouse button.
5. If necessary, repeat the growing process for the tissue not yet segmented.
6. To undo an action, click the **Undo**  button, to redo the canceled action click the **Redo**  . However, keep in mind that the tool will operate at regular intervals, so with a single click on the **Undo** button, you can only delete that part of the structure mask that was added as part of the previous execution or a series thereof, but not along.





## 6.8.2 Brush restore tool



---

Functionality is available in the **Pro** edition

---

To fill out the structure mask using the **Brush restore** tool:

1. Activate the **Brush restore**  tool by clicking the left/right/middle mouse button. To continue work with this tool, use the button with which the tool was activated. To learn more about tool control, see Section 1.14.
2. Set the tool diameter. To do this, move the mouse cursor up and down, holding the **Alt** key on the keyboard.
3. Move the mouse cursor to the area for which you want to create a structure mask.
4. Click the mouse button. The tissues that are under the editing mask and inside the sphere will be added to the mask. The tissue color changes to the one set for the structure.
5. To undo the action, click the **Undo**  button, to repeat the canceled action, click the **Redo**  button.
6. To add a large area to the structure, move the **Brush restore**  tool, holding the mouse button. However, keep in mind that the tool will operate at regular intervals, so with a single click on the **Undo** button you can only delete that part of the structure mask that was added as part of the previous execution or a series thereof, but not along.

7. To remove a part of the tissue from the structure, activate the **Brush cut**  tool. The tool works in the same way as to the **Brush restore** tool, but unlike the **Brush restore** tool, it removes the tissue from the structure.
8. To disable or enable the editing mask, click the visibility button  on the Editing mask panel.

In the Volume Reconstruction window, the tool is used for structure mask growth regardless of the editing mask. To grow a structure mask, use **Restore by mask** tool. Note that to fill the structure mask, you need some volume (base volume or the structure) to be visible. The visibility button (see the red arrow in Fig. 6.23) turn on visibility of all masks and surfaces for this structure. Otherwise, you won't be able to grow another mask.

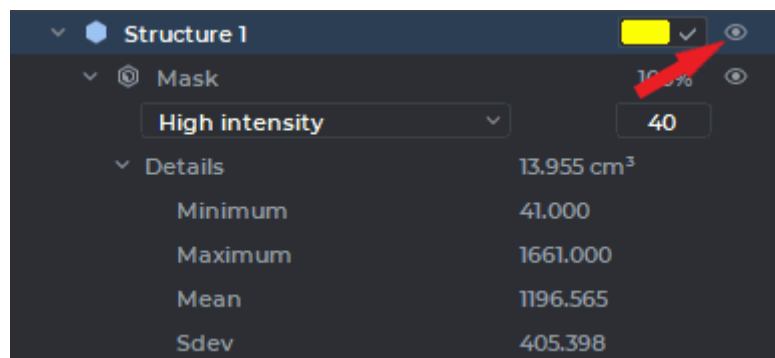





Figure 6.23: Button to change the visibility of all masks and structure surfaces



### 6.8.3 Region growing tool

Functionality is available in the **Pro** edition



When using the **Brush restore** tool, there may be leaks (structure mask beyond the required area). The  **Region growing** tool takes into account the shape and density of the segmented areas and allows users to minimize leaks. The tool has two modes: **EDT Method** and **Level Set Method**. To switch the mode, click the arrow on the right of the  button and select the desired mode. The current mode is marked by the flag.



The **EDT Method** mode allows you to create a structure mask in the editing mask space. To create a structure mask:

1. Activate the **Region growing**  tool in the **EDT Method** mode by clicking the left-/right-/middle mouse button. To continue work with this tool, use the button with which the tool was activated. To learn more about tool control, see Section 1.14.
2. Select the point on the editing mask roughly in the center of the region you want to segment.

3. Move the cursor in any direction, holding the mouse button. The structure mask will grow. The growth occurs faster in those directions in which the curvature of the surface is less (in thin sections the growth is slower to avoid leaks). The direction of the cursor movement does not matter, the distance from the starting point of the movement is important. When the cursor moves in the opposite direction, the structure does not decrease.
4. If the structure mask is completely created or if any further growth leads to leaks, stop the growing process by releasing the left mouse button.
5. If necessary, repeat the growing process for the tissue not yet segmented.
6. To undo an action, click the **Undo**  button, to redo the canceled action, click the **Redo**  button. However, keep in mind that the tool will operate at regular intervals, so with a single click on the **Undo** button you can only delete that part of the structure mask that was added as part of the previous execution or a series thereof, but not along.

If the **Level Set Method** is selected, the tool uses its own editing mask created according to a special algorithm. Hence, the created structure mask can go beyond the standard editing mask, and when you change the mask boundaries, it will be visible. To create a structure mask:

1. Activate the **Region growing**  tool in the **Level Set Method** mode by clicking the left/right/middle mouse button. To continue work with this tool, use the button with which the tool was activated. To learn more about tool control, see Section 1.14.
2. Select the point on the mask roughly in the center of the region you want to segment.
3. Press and hold the mouse button. A separate blue tool editing mask appears in the window in which you are working. If the mask is poorly visible against the background of the standard editing mask, reduce the opacity of the editing mask. To do this, reduce the opacity value in the **Editing Mask** panel (see Section 6.2.2).
4. Access the coverage of the tissues by the blue editing mask. The density of the tissues that are under the blue editing mask depends on the density under the cursor. If the blue editing mask is not built correctly, then release the left button, cancel the mask creation by clicking the **Undo**  button or deleting the mask; move the cursor to the tissue section with the desired density, and repeat this step.
5. The red circle around the cursor shows the curvature of the areas that will be segmented (the smaller the diameter of the circle is, the greater curvature is allowable, that is, the thinner tissues will be segmented). To change the diameter of the circle, move the cursor up or down, pressing the **Alt** key on the keyboard.
6. Move the cursor in any direction, holding the mouse button. The structure mask will grow under the blue editing mask. If the blue editing mask goes beyond the standard editing mask, the mask can be built beyond the standard editing mask, but it will be visible only within the standard editing mask.

7. If the structure mask is completely created or if any further growth leads to leaks, stop the growing process by releasing the mouse button.
8. If necessary, repeat the growing process for the tissue not yet segmented.
9. To undo an action, click the **Undo**  button, to redo the canceled action click the **Redo**  button. However, keep in mind that the tool will operate at regular intervals, so with a single click on the **Undo** button you can only delete that part of the structure mask that was added as part of the previous execution or a series thereof, but not along.

If the volume model is open (see Section 5.21), then the created structure appears simultaneously on the model. This causes additional load on the processor. If you want to reduce the load, click the arrow on the right side of the **Growing Region**  button and uncheck the **Interactive 3D Update** item. After this the structure on the volume model will be updated after the next structure creation phase is completed. The visibility of the surface does not affect the ability to edit the structure mask. The segmentation tools work if visibility for the structure and/or surface mask is enabled.

## 6.8.4 Vessel tree segmentation tool

Functionality is available in the **Pro** edition



The tool is used for blood vessels segmentation.

Segmentation is performed only for the visible part of the structure (base volume). Before using the tool, delete the parts of the image you don't need with the help of cutting tools. For lung vessels you can use the lung vessels area selection tool. To do that, click on the arrow in the right-hand part of the **Vessel tree segmentation** button and choose **Extract lung vessels area**. It may take time. After the lung vessels area has been selected, a colour lookup table «[WL]High Intensity» is assigned. For details on CLUTs see Section 2.22.



**The Extract lung vessels area tool works correctly only on studies with contrast.**

To perform segmentation:

1. Select the target structure (the base volume). The visibility  button turn on visibility of structure mask.
2. Activate the **Vessel tree segmentation**  tool by clicking the left/right/middle mouse button. To continue work with this tool, use the button with which the tool was activated. To learn more about tool control, see Section 1.14.
3. Specify the following parameters in the dialog box:
  - **Max vessel diameter (cm)**. The higher is the value of this parameter, the larger vessels are detected. At the same time, the risk of misrecognition of other tissues and mistaking a group of vessels for one vessel increases. If a smaller value is

provided, the vascular tree is divided into several trees, as large vessels connecting smaller trees are excluded.

- **Vessel tree structures count.** The parameter limits the maximum number of vessel tree structures. The structures are only created for the largest trees.

After segmentation has been completed, the tool remains active for work with the trees. The segmentation panel shows the structures created. To select a vessel, move the cursor to the vessel. To select a vessel and its subtrees, move the cursor while holding the **Shift** button. Figure 6.24 shows a vessel that has been selected.

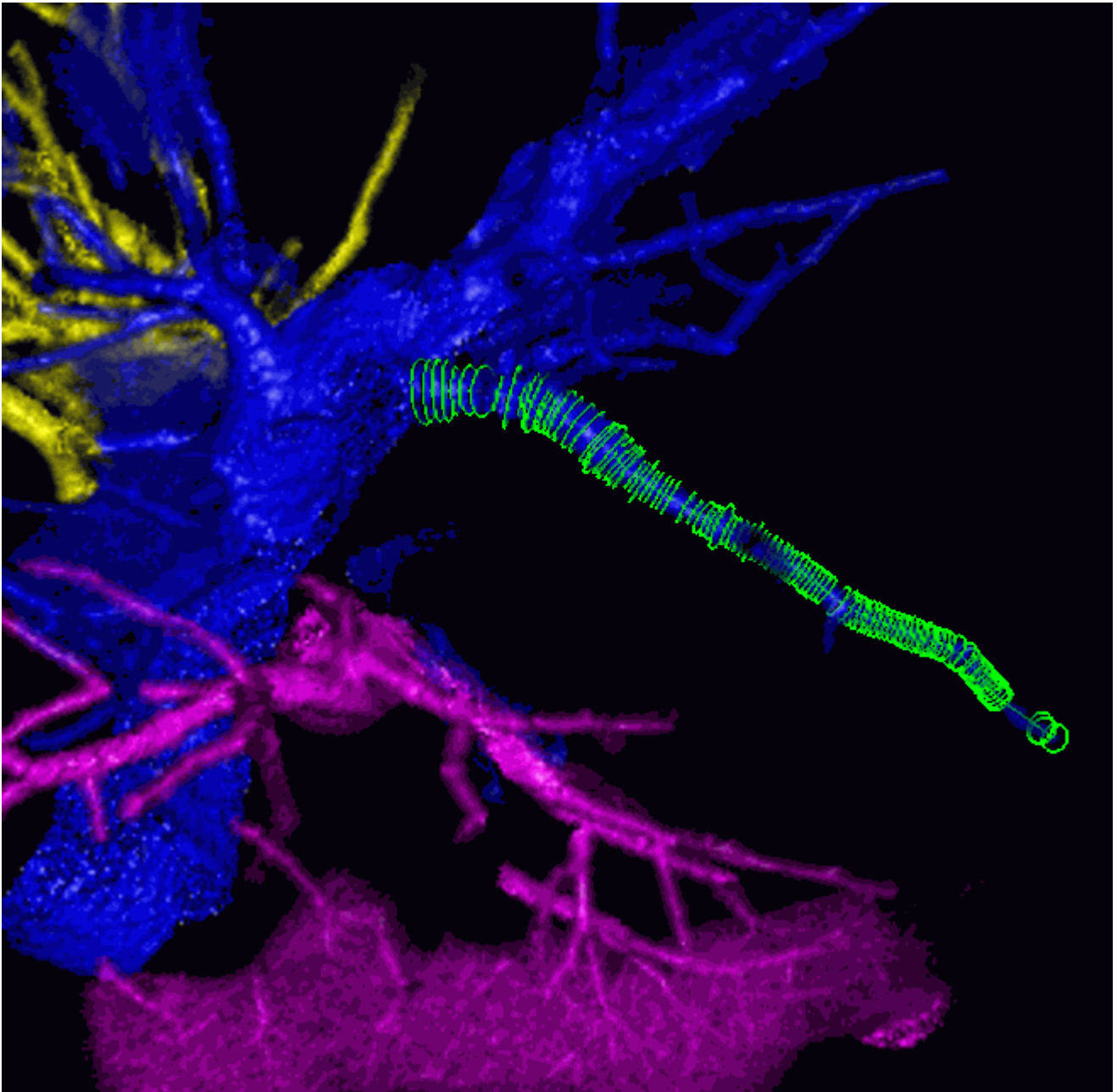



*Figure 6.24: The vessel selected*

To join a vessel to another tree, select the respective tree structure on the segmentation

panel, choose the vessel with the cursor, so that it is highlighted, and click on it. The vessel and the structure will be the same colour.

The vessels that are not related to any trees are considered invalid. To disconnect a vessel from one tree without connecting it to any other trees, you just need to mark it as invalid. To do that, select the vessel with the cursor and double-click it or click holding down the **Ctrl** key on the keyboard. Use the button with which the tool was activated. You can choose an incorrect vessel on the base volume holding down the **Alt** key on the keyboard and join it to any tree.

After the tool has been deactivated, you can no longer select vessels, join them or mark as invalid. To proceed with the trees created, click the **Vessel tree segmentation**  button. A warning will appear on the screen: **The vessels are already computed for that volume. Do you want to recompute them using current structure mask?** click **No** in the dialog box.

To perform vessels segmentation without deleting the results of the previous segmentation, choose the structure (base volume), for which you need to perform segmentation, click the **Vessel tree segmentation**  button and click **Yes** in the dialog box. The vessels that have been created after you used the tool for the last time will be selected.

### 6.8.5 Watershed segmentation tool

---

Functionality is available in the **Pro** edition

---

The tool is used for segment volume using the watershed method and allows you to split the volume into several non-overlapping parts.

The tool has two modes (directions for basin filling):

1. **low density** for the separation of soft tissues surrounded by more dense tissues: organs containing air, as well as the brain. In this case, the filling of the basins progresses from a lower tissue density to a greater one. The minimum density of tissues (**Min density**) is the point from which the filling of the basins begins, and the **Max density** value limits the density of the tissues to be segmented from above.
2. **high density** for separation of dense tissues surrounded by less dense tissues: bones and contrasted organs. In this case, the filling of the basins begins with the maximum density (**Max density**) and progresses in the direction of its reduction. The minimum density of the tissues to be segmented is limited from below by the **Min density** value.

To speed up the segmentation process and avoid the creation of unnecessary segments, exclude unnecessary tissues from the segmented volume, using the cutting tools.

To perform the Watershed segmentation:

1. Select the volume to be segmented.
2. If necessary, cut off the tissues that do not need to be segmented.
3. Activate the **Watershed segmentation**  tool by clicking the left/right/middle mouse button. To continue work with this tool, use the button with which the tool was activated. To learn more about tool control, see Section 1.14.



4. In the dialog that opens, set the following parameters:
  - **Min density;**
  - **Max density;**
  - **Min depth:** the minimum depth of basins which can be combined;
  - **Max basins:** the maximum number of created structures (no more than 31);
  - Select the mode (**Low density, High density**);
  - Select the source structure for segmentation from the **Source** drop-down list.
  - To set this structure as default, check the **Remember selected structure** box.
  - To hide the source structure, check the **Hide source structure** box.
  - To hide the structures which will not be changed after segmentation, check the **Hide other structures** box.
5. Click **OK** to perform segmentation or **Cancel** to cancel action. The process takes some time.

After the segmentation is complete, you can manually distribute the tissue into the basins, using the markers of the segmented structures. If the tissues do not fall into the required structure, it is necessary to install the markers corresponding to the structure on this tissue.



**Warning! The structure changes made using markers cannot be undone!**

To perform the watershed segmentation using markers:

1. Select a structure on the list.
2. Activate the **Segment marker**  tool by clicking the left/right/middle mouse button. To continue work with this tool, use the button with which the tool was activated. To learn more about tool control, see Section 1.14.
3. Add one or more markers in the required places by clicking the mouse.
4. If necessary repeat steps 1-3 for the other structures.
5. Click the **Watershed segmentation**  button.
6. Make sure the **Use structure markers** box is checked.
7. Select the source structure for segmentation from the **Source** drop-down list.
8. To set this structure as default, check the **Remember selected structure** box.
9. To hide the source structure check, the **Hide source structure** box.
10. To hide the structures which will not be changed after segmentation, check the **Hide other structures** box.
11. Click **OK** to perform segmentation or **Cancel** to cancel action. The process takes some time.

If the markers of different structures are put in one basin then the segmentation fails.

The source structure is not modified. The structures without markers are not modified.

To show/hide markers for the selected structure, click on the right side of the **Segment marker**  button and check/uncheck the **Show current structure markers** box in the button menu (Fig. 6.25). The selected item is marked with a flag.

To show/hide marker numbers for the selected structure check/uncheck the **Show current structure marker numbers** box. The option is disabled by default. This function simplifies work with structures having many markers. E.g., if a watershed segmentation attempt results in an error, this function helps you find out the number of the marker that caused this error. The selected item is marked with a flag.

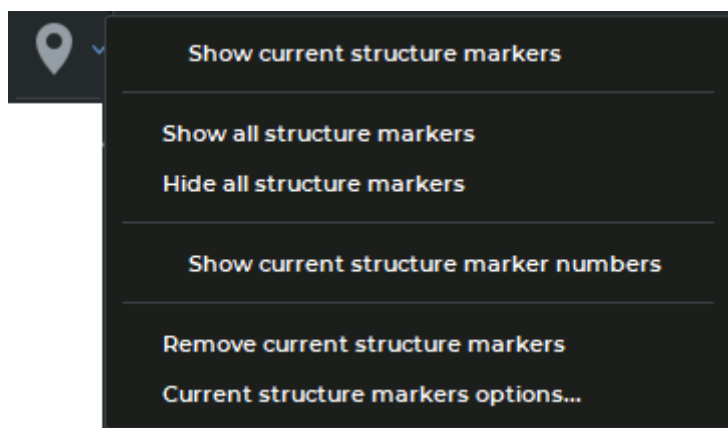



Figure 6.25: «Segment marker» button menu

To show/hide markers for all segmented structures, click on the right side of the **Segment marker**  button and select the **Show all structure markers** or **Hide all structure markers** respectively.

To remove markers from the current segmented structure select the **Remove current structure markers**.

To change marker parameters of the selected structure, select the command **Current structure markers options...**

The other features of the segment markers are similar to those described in Section 5.12.

If segmentation is performed for a fused series, then only markers for the selected layer are displayed. Markers are editable regardless of which structure is selected.

### 6.8.6 Multi-segment growing tool



---

Functionality is available in the **Pro** edition

---

This tool is used when it is necessary to increase masks of several structures so that they do not intersect. It is similar to **Grow (dilation)** (see Section 3.8.7), but can be applied simultaneously to an arbitrary number of structures and to the base volume. To use the tool:



1. Build the required number of structures whose masks you want to increase without intersection.
2. Activate the **Multi-segment growing**  tool (see Section 3.8.7). The dialog shown in Fig. 6.26 will be displayed.
3. The currently selected structure (base volume) is marked with a flag in the dialog. Check all the structures (base volume) whose masks you need to simultaneously increase with flags. If only one structure (volume) is checked, then the tool works similarly to the **Grow (dilation)** tool.
4. Set the maximum growing radius in the **Growing radius (mm)** field.
5. Click **OK** to apply the tool or **Cancel** to cancel action. The process takes some time. If the building is incomplete, repeat steps 2-4.
6. To undo or redo the action, use the **Undo**  and **Redo**  buttons for each structure you have built up.

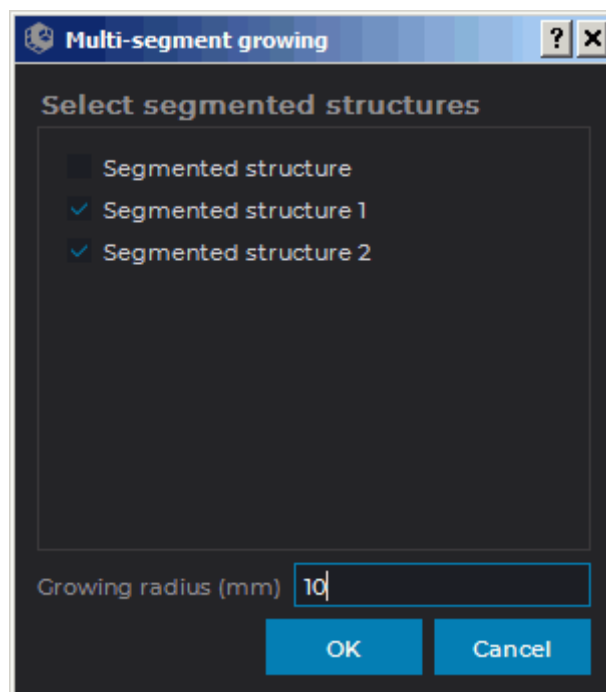



Figure 6.26: Multi-segment growing settings dialog

## 6.8.7 Segmented structures regions growing Tool

Functionality is available in the **Pro** edition

This tool is used when several masks of segmented structures are to be grown in one iteration (including within editing mask) so that they do not meet. To use this tool, you need at least one structure that is not empty.

Proceed as follows:

1. Click the **Segmented structures regions growing**  button. The dialog box shown in Fig. 6.27 will pop up.
2. In this dialog box, choose the structures whose masks to be grown.
3. If required, choose a structure or the main volume as the editing mask. You cannot choose the same structure for growing and as the editing mask.
4. Click **OK** to grow the structure or **Cancel** to cancel the operation. The process may take some time.

To undo this action, click the **Undo**  button, to redo the action, click the **Redo**  button.

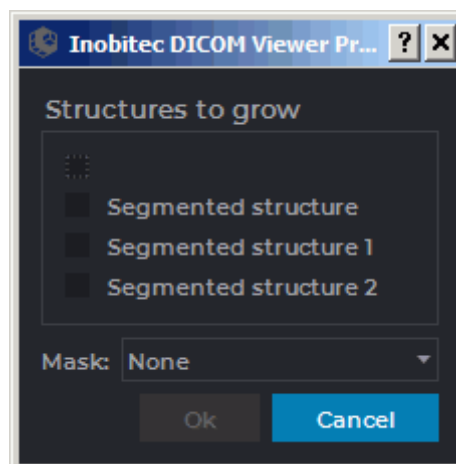

Figure 6.27: Dialog box for setting segmented structures regions growing





In the tab for viewing the volume reconstruction, the mask is grown within the color table assigned to this structure; in the tab for viewing the multiplanar reconstruction — within the green editing mask.

The growth speed has exponential relationship with the distance to the boundaries of the editing mask within which the structure is grown. It allows for effective division of the areas linked by narrow connectors.

## 6.9 Union, subtraction and intersection of structures

Functionality is available in the **Pro** edition

This tool allows you to create the unions, intersections and subtractions structures masks. The button will look different depending on which instrument was last used:

	<b>Union</b> (selected by default)
	<b>Subtract</b>
	<b>Subtract dilated</b>
	<b>Intersect</b>

To use a tool that is already selected, simply click on the tool buttons. To select another tool, click on the arrow on the right of the button and select an appropriate item from the list.

### 6.9.1 Union

Functionality is available in the **Pro** edition

The unification structures masks is the addition of one structure mask to another. The structure mask added structure remains unchanged. To unite structures masks of structures:

1. Select the current structure on the Segmented Structure Panel (e.g., the left lung).
2. Click on the **Union**  button. The dialog box shown in Fig. 6.28 will be displayed.
3. Select the structure with the mask of which you want to merge the mask of the current structure. (e.g., the right lung). If you want to make the right lung invisible after the merging process, check the **Hide selected structure** box. To make it visible later, enable its visibility with the change structure visibility button on the segmented structure panel.  
If you want to hide the base volume, check the **Hide selected layer base volume** box. If you want the base volume to be displayed, enable its visibility with the change structure visibility button on the segmented structure panel.
4. If the **Place the result in a new structure** box is checked, a new structure is created, in which mask the procedure result is placed. The current structure is not changed.
5. To merge masks of structures, click **OK**, to cancel, click **CANCEL**.

After the merging process, the original structure tissue will consist of the tissues contained in both structures.

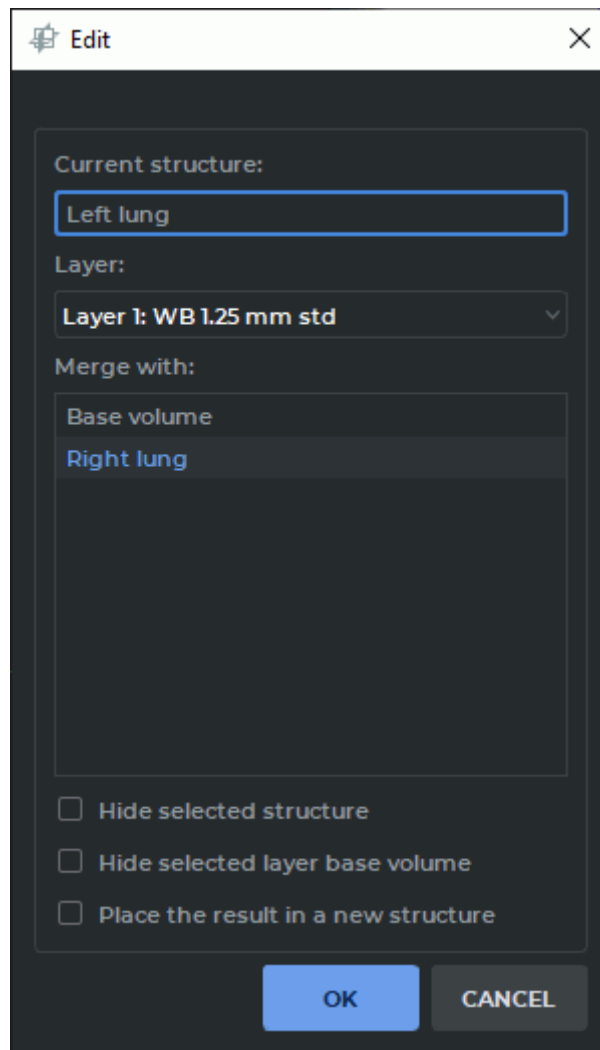

Figure 6.28: Union

## 6.9.2 Subtraction

---

Functionality is available in the **Pro** edition

---

The subtraction structures masks is the removal of voxels present in the mask of another structure from the original structure mask. To subtract structure masks:

1. Select the current structure on the Segmented Structure Panel (e.g., the lungs).
2. Click on the **Subtract**  button. The dialog box, similar to the one shown in Fig. 6.28, will be displayed.

3. Select the structure whose mask you want to subtract from the current one (e.g., the right lung). If you want to make the right lung invisible after subtraction, check the **Hide selected structure** box. To make it visible later, enable its visibility with the change structure visibility button on the segmented structure panel.

If you want to hide the base volume, check the **Hide selected layer base volume** box. If you want the base volume to be displayed, enable its visibility with the change structure visibility button on the segmented structure panel.

4. If the **Place the result in a new structure** box is checked, a new structure is created, in which mask the procedure result is placed. The mask of current structure is not changed.

5. To subtract, click **OK**, to cancel, click **CANCEL**.

After subtraction, the right lung tissue will be removed from the original structure (Lungs).

### 6.9.3 Intersection

---

Functionality is available in the **Pro** edition

---

The intersection structures masks is the removal of all voxels from the one structure mask except those present in the masks of both structures. To intersect structures masks:

1. Select the current structure on the Segmented Structure Panel.
2. Click on the **Intersect**  button. The dialog box, similar to the one shown in Fig. 6.28, will be displayed.
3. Select the structure whose mask you want to intersect with the current one. If you want to make the second structure invisible after intersection, check the **Hide selected structure** box. To make it visible later, enable its visibility with the change structure visibility button on the segmented structure panel.

If you want to hide the base volume, check the **Hide selected layer base volume** box. If you want the base volume to be displayed, enable its visibility with the change structure visibility button on the segmented structure panel.

4. If the **Place the result in a new structure** box is checked, a new structure is created, in which mask the procedure result is placed. The mask of current structure is not changed.

5. To intersect, click **OK**, to cancel, click **CANCEL**.

After intersection, the current structure will consist of the tissues contained in both structures.

### 6.9.4 «Subtract dilated» Tool

Functionality is available in the **Pro** edition

The **Subtract dilated** tool performs the morphological opening operation for the radius provided after subtraction. The morphological opening procedure is performed for the voxels corresponding to the voxels obtained as a result of dilation of the structure mask with the same radius. The radius is provided by the user in millimeters or voxels.

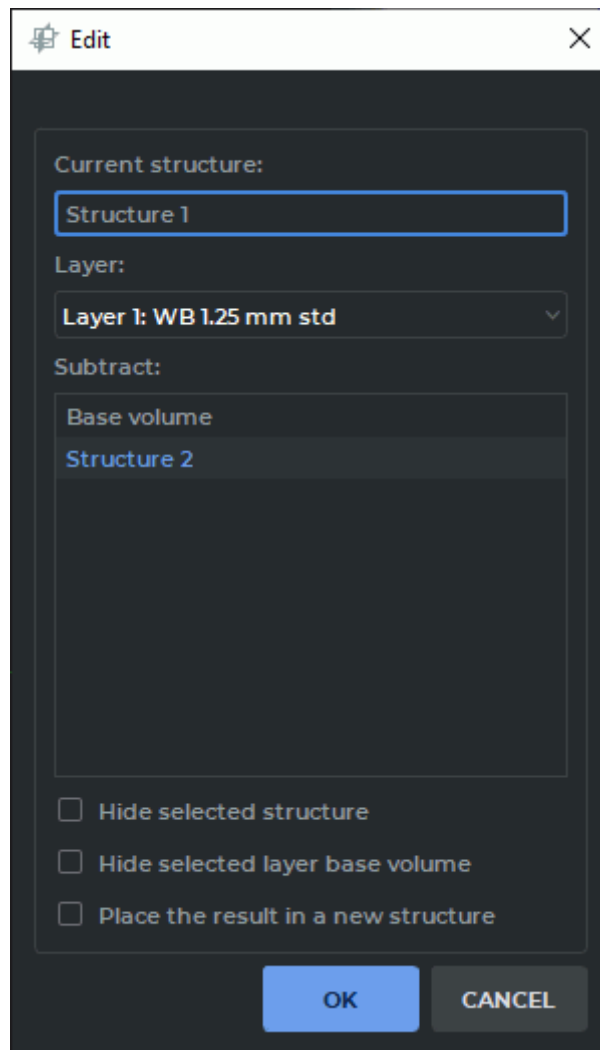



Figure 6.29: Editing structures dialog

To subtract structure mask:

1. Select the current structure on the Segmented Structure Panel (e.g., «Structure 1»).
2. Click on the **Subtract dilated**  button. The dialog box shown in Fig. 6.29.

3. Select the structure whose mask you want to subtract from the current one (e.g., the «Structure 2»). If you want to make the Structure 2 invisible after subtraction, check the **Hide selected structure** box. To make it visible later, enable its visibility with the change structure visibility button on the segmented structure panel.

If you want to hide the base volume, check the **Hide selected layer base volume** box. If you want the base volume to be displayed, enable its visibility with the change structure visibility button on the segmented structure panel.

4. In the **Place the result in a new structure** box is checked, a new structure is created, in which mask the procedure result is placed. The mask of current structure is not changed.
5. Click the **OK** button to apply the settings or **CANCEL** to cancel.
6. In the dialog box (Fig. 6.30), set the operation radius in millimeters or voxels.

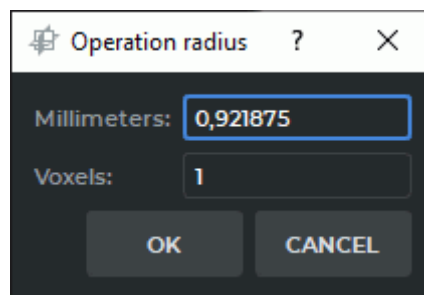

Figure 6.30: Operation radius dialog box

7. To subtract, click **OK**, to cancel, click **CANCEL**.

## 6.10 Building Mask with Contours

---

Functionality is available in the **Pro** edition

---

### 6.10.1 General Information

Contours are used for segmentation of the organs whose density is comparable with the density of the surrounding tissue, e.g the heart, the liver, and joints. In such cases, it is hard to see the boundaries of the region. Hence, the automatic segmentation procedure cannot be applied.

Contours are built on sections in the **MPR reconstruction** tab. If the **3D view** window is opened in the tab, the structure mask created is simultaneously shown on the volume model.

To customize the contours display, click the arrow on the right-hand side of the **Contour segmentation**  button and provide the required parameters in the menu.

- To enable/disable the contours display on the volume model, check/uncheck the box next to the **Show contours in 3D** option. By default, the option is enabled.
- To enable/disable the synchronization point display when the user hovers over the contour, check/uncheck the box next to the **Show syncpoint** option. By default, the option is disabled.
- to enable/disable automatic rebuilding of a structure mask in alignment with the contours, check/uncheck the **Interactive voxelization** box. By default, this option is enabled. If the interactive voxelization option is disabled, use the **Voxelize** unction on the tool context menu to rebuild the mask manually. For details, see Section 6.10.3.

## 6.10.2 Building a Structure Mask with Contours

To build a structure mask with contours, proceed as follows:

1. Open the study in the **MPR Reconstruction** tab. Create a structure with an empty mask and configure the editing mask by setting the tissue density. For the details on editing mask creation, see Section 6.2.1.
2. Activate the **Contour segmentation**  tool by clicking the left/right/middle mouse button. To continue work with this tool, use the button with which the tool was activated. To learn more about tool control, see Section 1.14.

Build the contour in one of the following ways:

- **Building contours manually.** Build a contour around the chosen area while holding the mouse button with which the tool was activated. To finish the procedure, release the mouse button. To cancel the contour that has not been closed, press **Esc** on the keyboard while holding the button.
  - **Building contours with an isoline.** Move the cursor around the selected area while holding the **Shift** button on the keyboard. Under the cursor, you will see an isoline characterized by even points density. You can only see an isoline on the surfaces where a contour can be built. To build a contour with an isoline, click the left mouse button or the mouse button with which the tool was activated.
3. Go to the next slice and draw a contour around the selected area. Contours are only built on parallel planes. Contours are used to create a mask with regard for the editing mask. You need at least two contours to build a structure mask.

Structure mask may not be shown on the sections with the first and the last contour.

**Building contours automatically with segmented structure sections.** Contours are built on the current section of the structure mask. The structure mask on which contours are built may be built with any tools. The following conditions must be met in order to build a contour on a structure mask:

- the current section must be placed in parallel with other contours;
- there must be no other contours of the same structure mask on the current section;
- the structure mask must be visible on the current section.



Mouse over a section parallel to the structure mask contours. The mask should be visible in the current slice. Click the right mouse button and select the **Create contour X** option from the menu, or press **X** on the keyboard. The contour will be built on the current section (indicated by the red arrow in the fig. 6.31) around the perimeter of the visible part of the current structure mask (indicated by the black arrow in the fig. 6.31). If a contour (or several contours) already exists on the current section, no other contour will be built.

To undo an action, click the **Undo** ↶ button, to repeat the canceled action, click the **Redo** ↷ button. You can use the **Undo** and **Redo** buttons to delete or restore the contours that were built in one click.

Contours projections are shown on perpendicular sections of the **MPR reconstruction** tab, in the **3D view** window and on the sections where they were built. If a slice is not perpendicular to the contour plane, the projection of this contour is not shown.

When you hover over the contour line, it is highlighted in all the windows of the tab.

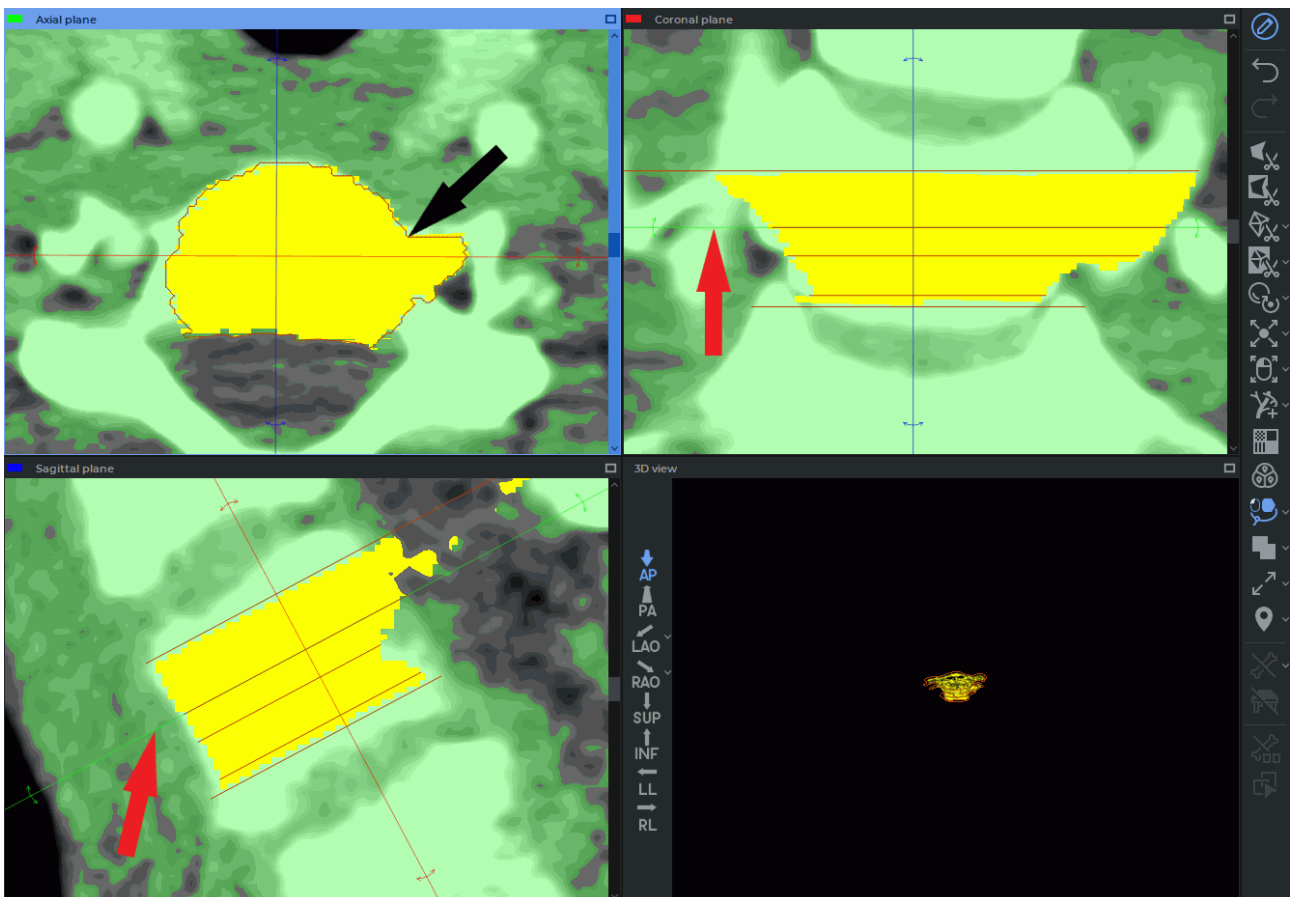

Figure 6.31: Building contours automatically with segmented structure sections

If the **Show syncpoint** option is enabled and the user hovers over the contour in any of the cutting plane windows or in the **3D view** window, the crosshair under the cursor and the synchronized crosshairs on the contours in other windows of the tab are displayed.

If you click the mouse button while the cursor is on the contour line in the **3D view** window, you will go to the section with this contour in the **MPR reconstruction** window.

### 6.10.3 Work with Contours

DICOM Viewer provides for the following actions with contours:

- **Editing.** To edit a contour, place the cursor over it. When you hover over the contour line, it is highlighted in all the windows of the tab. Place the cursor over the area that needs editing and click the mouse button. Draw a new contour while holding the button. To finish the editing procedure, release the mouse button.  
To undo an action, click the **Undo** ↶ button, to repeat the canceled action, click the **Redo** ↷ button. You can use the **Undo** and **Redo** buttons to delete or restore the parts of the contour that were built in one click (from the moment you press the mouse button to the moment the button is released);
- **Rebuilding a mask manually.** This function is used when the automatic structure mask rebuilding function is disabled in the **Contour segmentation** button menu. To do it, you need to mouse over the contour line, click the right mouse button and choose the **Voxelize** option on the context menu. If the contour is built for a structure mask created with the help of other tools, you will not be able to undo an action after voxelization. Before voxelization is performed, a dialog box pops up informing you that the change history will be lost (Fig. 6.10.3);

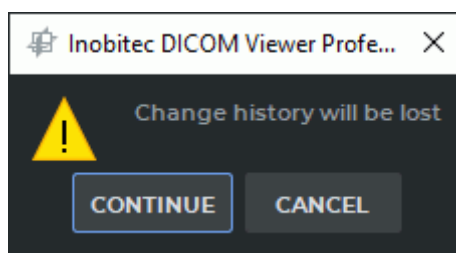

Figure 6.32: A message warning that the change history will be lost

To accept the changes, click the **CONTINUE** button. To cancel voxelization, click the **CANCEL** button.

- **Deleting.** Place the cursor over the contour line, press the **Delete** key on the keyboard or click the right mouse button and choose the **Remove contour** option in the right-click menu.  
To undo an action, click the **Undo** ↶ button, to repeat the canceled action, click the **Redo** ↷ button. You can use the **Undo** and **Redo** buttons to delete or restore the parts of the contour that were built in one click (from the moment you press the mouse button to the moment the button is released).

### 6.10.4 Setting the Contour Display Parameters

You can customize the contour display parameters in the **Tool options** dialog box (Fig. 6.33). The appearance and the functions of the **Tool options** dialog box depend on the way

you call for it. There are two ways to call for the **Tool Options** dialog box:

1. Place the cursor over the contour line, click the right mouse button and choose the **Tool options...** point in the right-click menu. The dialog shown in Fig. 6.33a appears.
2. On the volume editing panel, click the arrow on the right-hand side of the **Contour segmentation**  button and select **Default options...** from the button menu. The dialog shown in Fig. 6.33b appears.

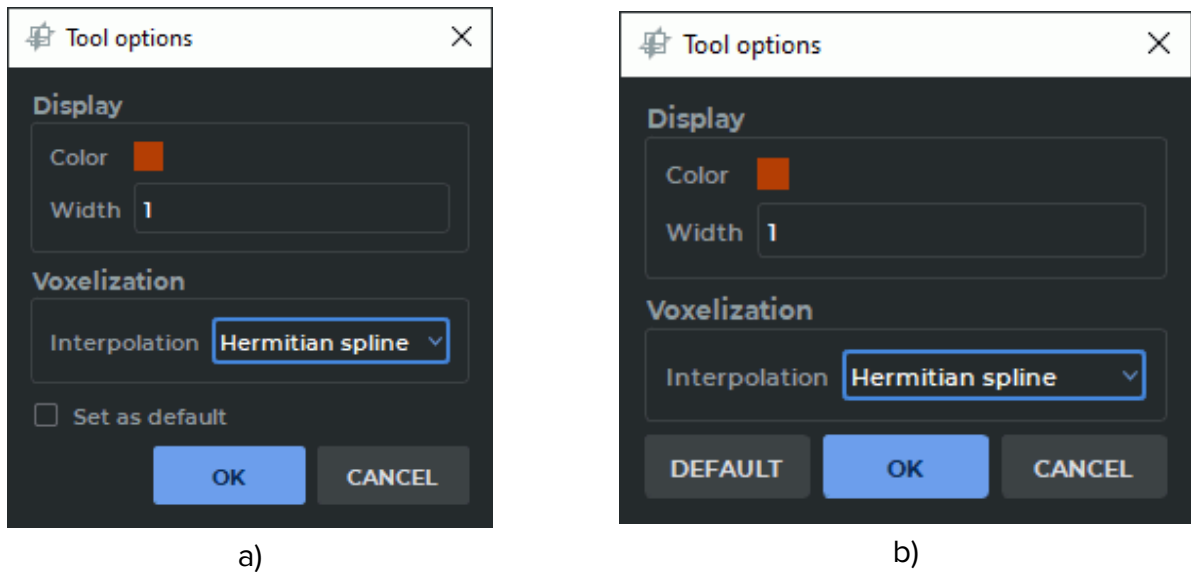

Figure 6.33: Contour parameter settings dialog box

In the dialog box that pops up (see Fig. 6.33), in the **Display** section select the color and the contour line thickness in pixels. From the **Interpolation** drop-down list in the **Voxelization** section, select the interpolation type for the segmented structure built with contours. The interpolation types available are:

- **Linear**;
- **Hermitian spline** (set by default).

The interpolation type chosen will be displayed next time you open the structure selection dialog box.

The parameters selected in the dialog box Fig. 6.33a will be applied to the contours of the current structure mask. If you check the **Set as default** box, the settings will be used by default when building the contours of a new structure mask.

The parameters set in the dialog box shown in Fig. 6.33b are applied by default to the **Contour segmentation** tool. The changes are not applied to the built contours of masks. To restore the initial tool parameters, click the **DEFAULT** button.

Click **OK** to apply the settings or **CANCEL** to cancel.

## 6.11 Saving and Opening Segmentation Projects and DTI Projects

---

Functionality is available in a separate module which is activated in the Pro edition for an extra fee

---

The DICOM Viewer allows for saving segmentation projects and DTI projects in a file. One project may contain structures and DTI data from different series, as well as source DICOM data. If a project was saved without source DICOM data, it cannot be opened without downloading the corresponding series first.



**Save segmentation project to file**  and **Open segmentation project from file**  buttons (shown with the red frame in Fig. 6.34) are located on the segmented structures panel.



Figure 6.34: Project management buttons

### 6.11.1 Saving a Project

---

Functionality is available in a separate module which is activated in the Pro edition for an extra fee

---

To enable/disable the saving of source DICOM data, on the main menu, select **Options->Settings...->Modules->3D reconstruction**, then choose the **Project** tab and check/uncheck the **Save DICOM data of series** box. This option is activated by default.

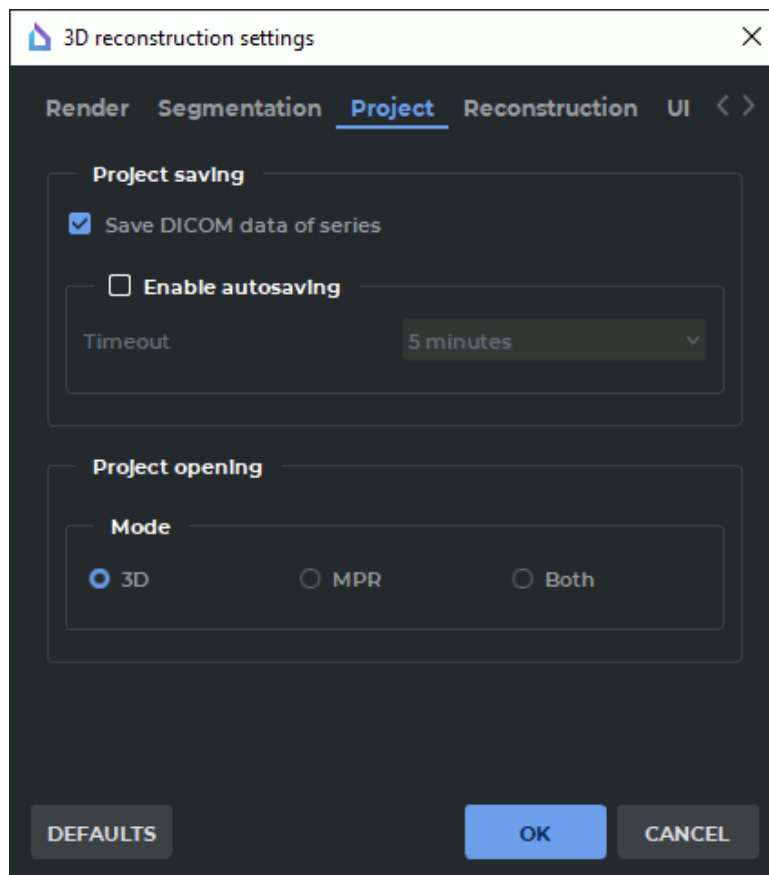



Figure 6.35: 3D reconstruction settings

The **DEFAULTS** button restores the checkbox **Save DICOM data of series**. Click **OK** to apply the settings or **CANCEL** to cancel.

To save a project, click the **Save segmentation project to file**  button on the segmented structures panel. In the dialog box that pops up, provide the path to the file and the file name. Click **OK** to save or **Cancel** to cancel. The project file has (spj) extension.

When a project is saved, the data regarding the visibility and minimization status of all the elements on the segmentation panel list, as well as the data regarding the model orientation and projection are saved. When the project is opened again, the visibility and minimization status of the elements on the segmentation panel list, as well as the model orientation and projection will be restored. If you open a project created by a user of the DICOM Viewer 2.14 or inferior, the status of the elements on the segmentation panel list will be determined in compliance with the status of the **Collapse new structure on creation** setting which can be found on the **Segmentation** tab, **3D Reconstruction** module settings (see Section 16.7.3).

If the project is opened in the **MPR reconstruction** tab, the following characteristics are restored:

- cutting planes turn and arrangement;
- model position;
- model scale.

The turn of the model slice in the **MPR reconstruction** tab is not restored.

If the project is opened in the **Volume reconstruction** tab or in the **3D view** window of the **MPR reconstruction** tab, the following characteristics are restored:

- model turn;
- model position;
- model scale;
- projection type.

If the project was saved in the **MPR reconstruction** tab and opened in the **Volume reconstruction** tab, the parameters that can be applied only to the **3D view** window are restored.

The markers — **Marker**, **Line marker**, or **Polygonal line marker** — are saved in the project for each layer. The length and angle measurements performed with polygonal marker lines are saved in the project file. The work with markers is described in Section 5.12.

### 6.11.2 Saving Projects Automatically

---

Functionality is available in a separate module which is activated in the Pro edition for an extra fee

---

Segmentation projects are saved automatically to prevent loss of data as a result of a program crash caused by a technical failure or the user's actions. Autosave and data recovery are available in **MPR reconstruction** and **Volume reconstruction** tabs.

If the license for the extended segmentation module is active and it is the first time the user adds, deletes or edits

- a segmented structure or base volume;
- a surface for a segmented structure or base volume;
- a group of ROI DTI, or individual ROI DTI;
- a marker (except for segmented structure markers),

in the **MPR reconstruction** or **Volume reconstruction** tab, then a dialog box for segmentation projects autosave activation (Fig. 6.36) will pop up.

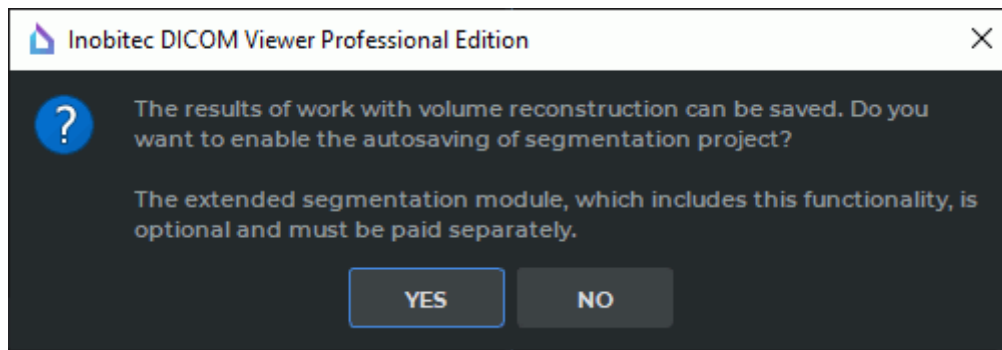

Figure 6.36: Dialog box for segmentation projects autosave activation

Click **YES** to enable segmentation projects autosave or **NO** to cancel.

To enable/disable segmentation projects autosave, on the main menu, select **Options->Settings...->Modules->3D reconstruction**, then choose the **Project** tab (Fig. 6.35) and check-/uncheck the **Enable autosaving** box. By default, segmentation projects autosave is disabled. On the **Timeout** dropdown list, select autosave frequency. The default value is five minutes.



**Autosave option is available only when the extended segmentation module is activated. If the extended segmentation module is not activated, the Enable autosaving option is automatically disabled.**

Segmentation projects are automatically saved in the background mode without blocking the interface. Autosave frequency may be selected on the **Timeout** dropdown list.

When a segmentation project is saved automatically, a file with `.autospj` extension is created in a temporary system folder. This file contains:

- segmentation results;
- visibility status of structures on the segmentation panel list:
  - base volume visibility is saved as visibility of a separate structure;
  - 3D model visibility is saved as visibility of a structure mask;
- collapsed status of elements on the segmentation panel list, including:
  - nested elements of the mask and the surface;
  - base volume elements which are saved as separate structures;
- DICOM data source information.

The DICOM data source may be:

- a local storage;
- a folder with DCM files;
- a DICOMDIR file;
- an XML file;
- a third-party SPJ file;

- an archive with DCM files.

The data concerning the changes in the base volume in different tabs working with the current segmentation project are saved as separate segmented structures. If the user works with the same segmentation project in several **MPR reconstruction** or **Volume reconstruction** tabs, the data are automatically saved in the same file.

If a segmentation project is saved manually with the help of the **Save segmentation project to file**  button on the segmented structures panel (see Section 6.11.1), the *.autospj* file is deleted automatically.

When the user closes the last tab of a segmentation project with unsaved changes, a dialog box for saving the project changes (Fig. 6.37) will pop up.

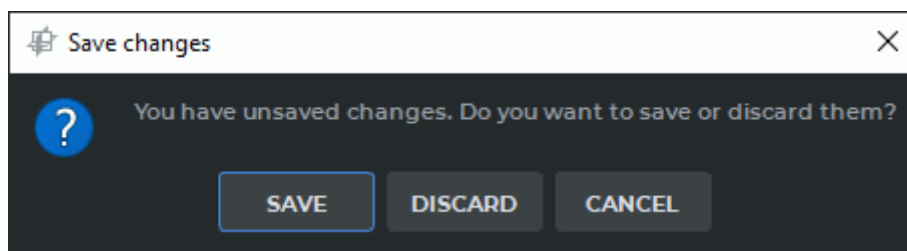

Figure 6.37: Dialog box for saving the changes in a segmentation project

Click **SAVE** to save the changes in the project or **DISCARD** to close the tab without saving the changes. To resume work on the project, click **CANCEL**. After the project has been saved or the changes have been discarded, the *.autospj* file is deleted automatically.

### 6.11.3 Resuming Work with Segmentation Projects

---

Functionality is available in a separate module which is activated in the Pro edition for an extra fee

---

If the segmentation projects autosave option is enabled, an *.autospj* file is created and saved in a temporary folder.

The name of the *.autospj* file is generated as follows:

*<patient name>\_<description of the 1st layer series>\_...\_<description of the n layer series>\_<project #>\_<time and date>.autospj*,

where *<project #>* — is the unique number that is automatically assigned to a segmentation project for a series or a fused series,

and *<time and date>* — is the time and date of the file creation in *hhmmssddMMyyyy* format, where «hh» stands for hours, «mm» — for minutes, «ss» — for seconds, «dd» — for the day, «MM» — for the month, and «yyyy» — for the year.

The maximum length of the *autospj* file name is 100 characters. If this limit is exceeded, the name will be cropped and a «~» symbol will be placed before *\_<project #>\_<time and date>*.



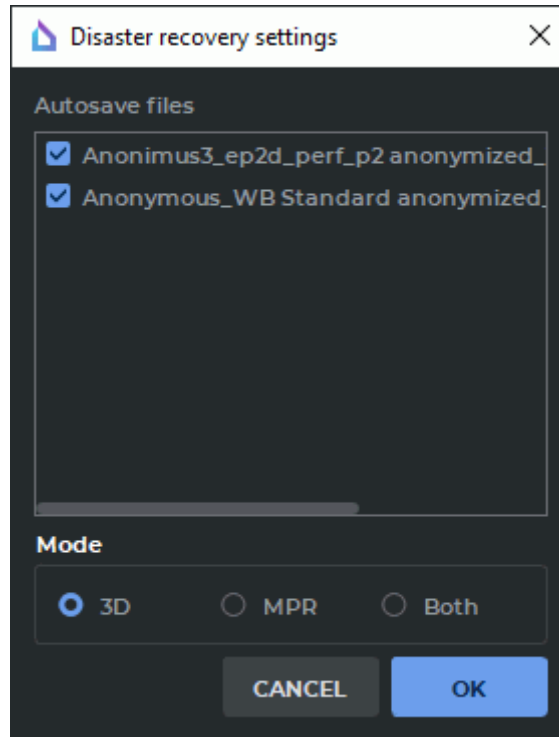

Figure 6.38: Dialog box with crash recovery settings

In case of the program crash, the project file is restored automatically when the DICOM Viewer is launched again. If there is an *.autospj* file in the temporary folder, it is decided that the project must be restored, and a dialog box for resuming work with the last autosaved version of the segmentation project pops up (Fig. 6.38).

In the **Disaster recovery settings** dialog box, check the autosaved files for the projects that have to be restored. If none of the files has been selected, the **OK** button is inactive. You can choose the mode in which the restored project will be opened: **3D**, **MPR** or **Both**. Click **OK** to open the selected segmentation project in the mode specified or **CANCEL** to cancel.

If there are several projects, work with them will be resumed in the order in which *.autospj* files are listed in the **Disaster recovery settings** dialog box. If any of the projects cannot be restored, it does not affect the other projects.

When you renew work with an automatically saved file, the visibility and collapsed status of the structures on the segmentation panel list will depend on the status of these structures at the time of the *.autospj* file creation.



**If you click CANCEL, .autospj files are deleted from the temporary folder.**

An *.autospj* file contains only the information on the third-party DICOM data source. If this source cannot be accessed, the segmentation project cannot be restored.

If the user cannot resume work with any of the segmentation projects as the DICOM data for the series are unavailable, a dialog box will pop up advising to save the data from the autosave file to a separate *.spj* file on the disk. After the user confirms that the data must be saved, a standard Save As dialog box pops up. The name of the file and its location are to be specified by the user.



After the file is saved or the user chooses not to save it, the .autospj file is deleted from the temporary folder.

### 6.11.4 Opening a Project with Source DICOM Data

Functionality is available in a separate module which is activated in the Pro edition for an extra fee

When a project is opened, the DICOM Viewer shows it in the **Volume Reconstruction** or **Multiplanar Reconstruction** tab. To choose a default tab, on the main menu, select **Options->Settings...->Modules->3D reconstruction**, then choose the **Project** tab (Fig. 6.35), and choose the **3D**, **MPR** or **Both** opening mode. The **3D** mode is chosen by default.

The **DEFAULTS** button restores the checkbox **Save DICOM data of series**.

Click **OK** to apply the settings or **CANCEL** to cancel.

Orientation and projection data on the model are saved in the project. The orientation and projection of the model is restored when the project is opened. For more information, see Section 6.11.1.

There are three ways to open a project containing source DICOM data in the default tab:

1. Choose the **Open project...** option in the **File** menu. Select the project file in the window that pops up. Click **Open** to open the project or **Cancel** to cancel.
2. Double-click with the left mouse button on the project file in the Explorer window. This function is available by default only on Windows OS. On macOS and Linux, you have to use the system functions to create a link between (spj) format and the DICOM Viewer software.
3. Drag and drop the project file to the DICOM Viewer shortcut (this option is only available on Windows and macOS). If you drag and drop several project files to the DICOM Viewer shortcut, each file will be opened in a separate tab.

To open a part of the project and specify the tab in which it is to be opened, proceed as follows:

1. On the main menu, select **File->Open project as...**. A window will pop up, in which you will have to choose the file containing the project for this series. Click **Open** to open the project or **Cancel** to cancel the action. The dialog box shown in Fig. 6.39 will pop up.
2. Choose the tab in which you want to open the project (**3D**, **MPR** or **Both**). The selected mode will be set by default.
3. Select the series in the **Series list** box that need to be opened. By default, all series of the project are selected. Uncheck the box against the series if you don't want it to be opened in the project.
4. The order in which the series are displayed is important for working with the project. By default, the series are displayed in the **Series list** in the same order as when the segmentation project was saved. To change the series order, highlight a series in the

**Series list** box. Use **Move up** and **Move down** buttons (indicated by the red frame in Fig. 6.39) to move the selected series up or down.

5. Click **OK** to open the project or **CANCEL** to cancel the operation.
6. The first series on the **Series list** is considered to be the basic series.
  - The basic series on the MPR tab is displayed as the background layer behind the other layers. The background layer is fixed. The center of the background layer coincides with the center of the window. You can move the layers about the background layer or each other with the help of the tools you see on the Fusion of layers panel. The procedure of merging layers is described in Section 4.3.
  - The project opened in the volume reconstruction window is displayed as 3D models created independently of each other. The basic series of the project is displayed as a 3D model fixed at the point of origin which is at the same time the center of the model. The models from other series are located in space with respect to the first layer model. The change of the order of the layers at the time of opening the project does not affect the mutual arrangement of the models.

If the project does not contain any source DICOM data, when you attempt to open it, an error notification will pop up: **Cannot find DICOM data in the project file**. The procedure of opening projects without DICOM data is described in Section 6.11.5.

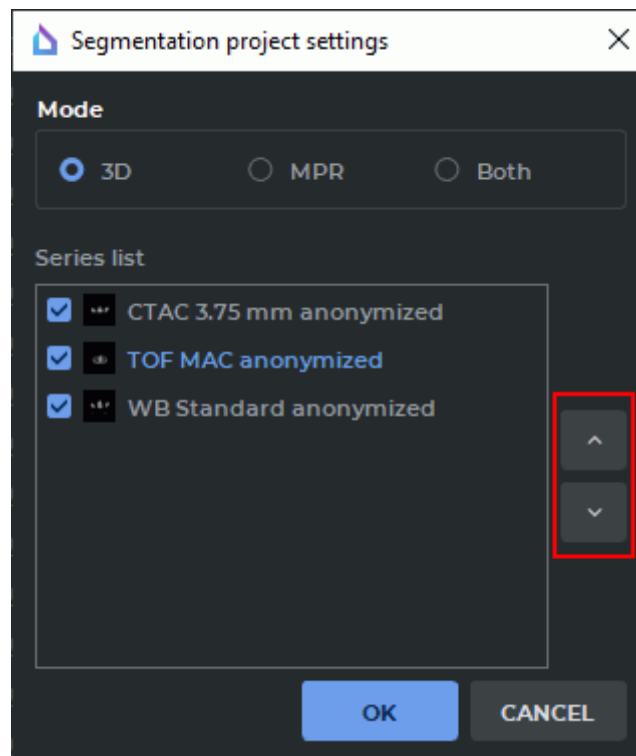

Figure 6.39: Dialog box for selecting the project opening parameters

## 6.11.5 Opening a Project without Source DICOM Data



---

Functionality is available in a separate module which is activated in the Pro edition for an extra fee

---

To open a project without source DICOM data, you first need to open the source data in the **Volume Reconstruction** or **Multipanar Reconstruction** tab.

To open a project that does not contain any source data:

1. Open the initial series for which the project was saved in the **Volume Reconstruction** or **Multipanar Reconstruction** tab.
2. Open the segmented structure panel by clicking the  button.
3. Click the **Open segmentation project from file**  button on the segmented structure panel. A window will pop up, in which you will have to choose the file containing the project for this series. Click **Open** to open the project or **Cancel** to cancel the operation.

Orientation and projection data on the model are saved in the project. The orientation and projection of the model is restored when the project is opened. For more information see Section 6.11.1.

The segmented structures and DTI data for this series contained in the project are added to the segmented structure panel. When the project is opened for the second time, the data are added again without replacing the old data. When the structures are edited on the segmentation panel, the file contents are not changed. If a project file contains data for several series, only the data referred to the series that is currently open on the volume or multipanar reconstruction tab will be added.

## 6.12 Histograms

---

Functionality is available in the Pro edition

---

The sections with color tables described in Section 2.22.3 are available for segmented structures. The difference is that in the Flat images view mode a histogram is built for the entire density range, and for the structure it is built only for the range of the density that corresponds to the structure mask.

## 6.12.1 Rendering a Histogram for a Structure

Functionality is available in the **Pro** edition

The DICOM Viewer provides for rendering histograms for the base volume and selected segmented structures.

To view a histogram for a selected segmented structure in the **MPR Reconstruction** window, click the  **Rendering transfer function** button on the toolbar.

At the bottom of the tab, you will see the panel of the rendering transfer function with the histogram for the selected segmented structure. The color of the histogram for the selected segmented structure will be the same as the user color of the segmented structure. The name of the segmented structure is provided in the histogram legend.

If you have chosen the base volume on the segmentation panel, then only the base volume histogram will be displayed on the panel of the rendering transfer function. The changes in the visibility and transparency of the selected segmented structure or the base volume do not affect the histogram rendering.

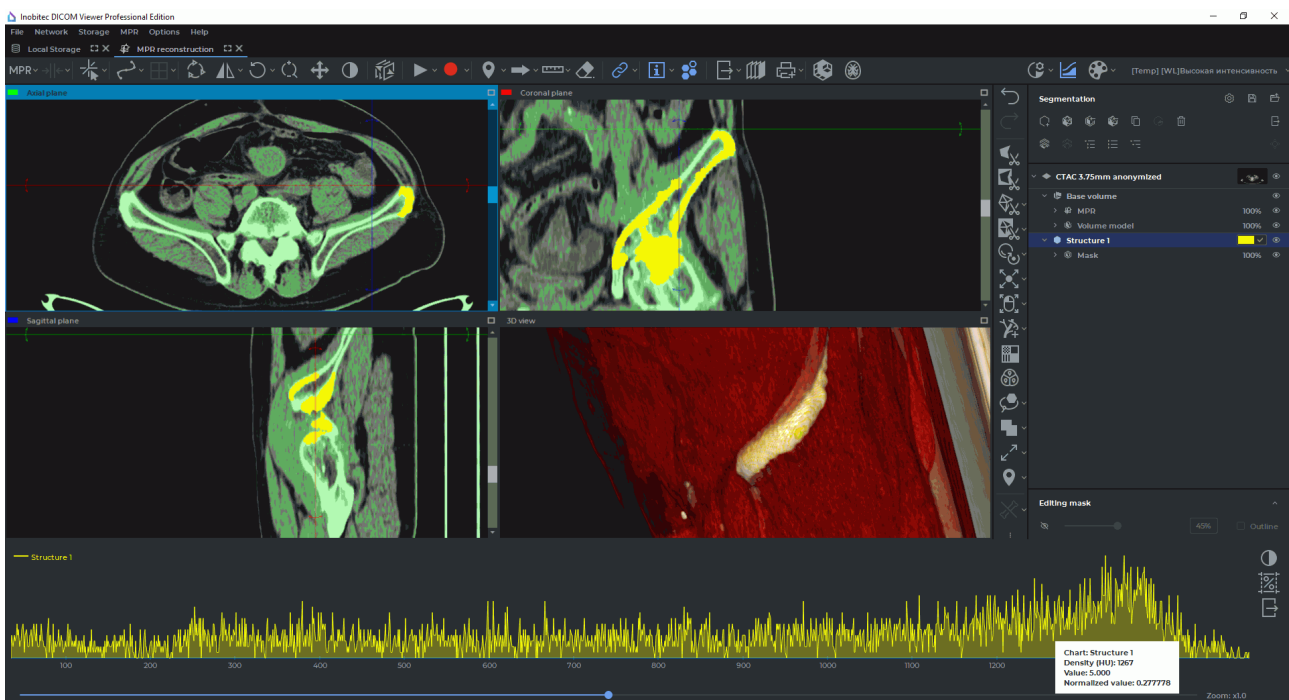

Figure 6.40: Histogram of segmented structure

When you hover over a point of the base volume or the selected segmented structure histogram, a tip pops up.

The pop-up tip provides the following parameters:

- **Chart** — the name of the histogram;
- **Density (HU)** — the Hounsfield density value;

- **Value** — the number of points characterized by the density value provided;
- **Normalized value** — is calculated by the following formula:

$$\frac{y - y_{min}}{y_{max} - y_{min}} \quad (6.1)$$

where:

$y$  — the present histogram value;

$y_{min}$  — the minimum histogram value;

$y_{max}$  — the maximum histogram value.

The base volume and the name of the segmented structure is stated in the histogram legend.

If the **3D view** window is active in the **MPR Reconstruction** tab, then the histogram for the base volume and the transfer function for the current color table will be displayed on the panel of the rendering transfer function.

When you hover over a point of the rendering transfer function graph, a tip pops up.

The pop-up tip provides the following parameters:

- **Density (%)** — the density measured as percentage of the window width/level (W/L). The parameter is calculated by the following formula:

$$D\% = (D - Min_{W/L}) * \frac{100}{Max_{W/L} - Min_{W/L}} \quad (6.2)$$

where:

$D$  — the density value;

$Min_{W/L}$  — the minimum window dimensions;

$Max_{W/L}$  — the maximum window dimensions;

- **Opacity** — the opacity value from 0.0 to 1.0.

The opacity value shown in the pop-up tip is rounded off to 0.001.

## 6.12.2 Histogram for a ROI

---

Functionality is available in the **Pro** edition

---

A histogram for a ROI is a graph for the density range of the points within the ROI. The DICOM Viewer displays histograms for ROI in the **Image Viewer** tab, **MPR Reconstruction** tab, and **PET Analysis** tab.

To view a histogram for a ROI in the selected window, click the  **Rendering transfer function** button on the toolbar. At the bottom of the study tab, you will see the rendering transfer function panel with the histogram for the ROI and the rendering transfer function over it.

In the **Flat Image Viewer** tab, the histogram is built for all the ROI displayed in the selected tab window. When you add a new ROI, scroll or switch windows, the histogram for the ROI is changed accordingly.

If you have chosen a mode where several images of the same series are displayed simultaneously, e.g. 2x2, 2x3 etc., then the histogram for the ROI is built in the top left-hand corner.

In the **MPR Reconstruction** tab, histograms for ROI are shown in the **Axial plane, Sagittal plane, Coronal plane**, and **Involute** windows. If the **MPR Reconstruction** tab is open for merged series, then, when you switch layers, the ROI histogram is changed in accordance with the density values for the current section of the layer selected.

In the **PET Analysis** tab, the histogram is built for all the ROI of the current image in the selected window: **PT, CT**, or **Fusion (PET+CT)**. In the **Fusion (PET+CT)** window, the histogram is built for the PET layer.

# Chapter 7

## Vessel analysis module

---

Functionality is available in a separate module which is activated in the Pro edition for an extra fee

---



**In Vessel Analysis window, diagnosis can only be established on the basis of CT and MR series. The anomalies detected should be studied using the original images in the Image Viewer window.**



**Errors may occur when intensity is measured in a certain point. In this case, the intensity value will be marked by an asterisk. For accurate measurements, use the bilinear interpolation filter (see Section 5.3).**

The DICOM Viewer allows you to open CT, MR and XA modality series in the Vessel analysis module.

The DICOM Viewer contains the Vessel analysis module (universal) and the Coronary artery analysis module (adapted for the analysis of the coronary arteries). Both of these modules are licensed separately. Their functionality basically coincides, and the differences are based on the location of the coronary arteries.

This chapter describes the Vessel analysis module. Differences related to the Coronary artery module are described in Section 7.8.

### 7.1 Open Studies in Vessel Analysis Module

---

Functionality is available in a separate module which is activated in the Pro edition for an extra fee

---

To open a study:

1. Load studies to the DICOM Viewer.
2. Select the angiographic study and the series with contrast.



3. Click the **Vessel analysis**  button on the toolbar. To select the tab location (in the current window, in a separate window or in the full screen mode), click on the arrow on the right side of the button. To open the virtual endoscopy window in a new tab in the current window, click on the button. The process may take some time.

If you open a CT study, then the DICOM Viewer prompt you to select a series without contrast to remove bones.



**The dialog box for selecting a non-contrast-enhanced series pops up automatically only if the series is opened for the first time. When the same series is opened again, the dialog box does not pop up, but you can open it manually in the menu of the «New vessel» button.**

The following series are not shown in the dialog box for selecting non-contrast-enhanced series (Fig. 7.1):

- Series with a modality other than CT;
- Series incompatible with 3D;
- The current series (opened in the **Vessel analysis** tab).

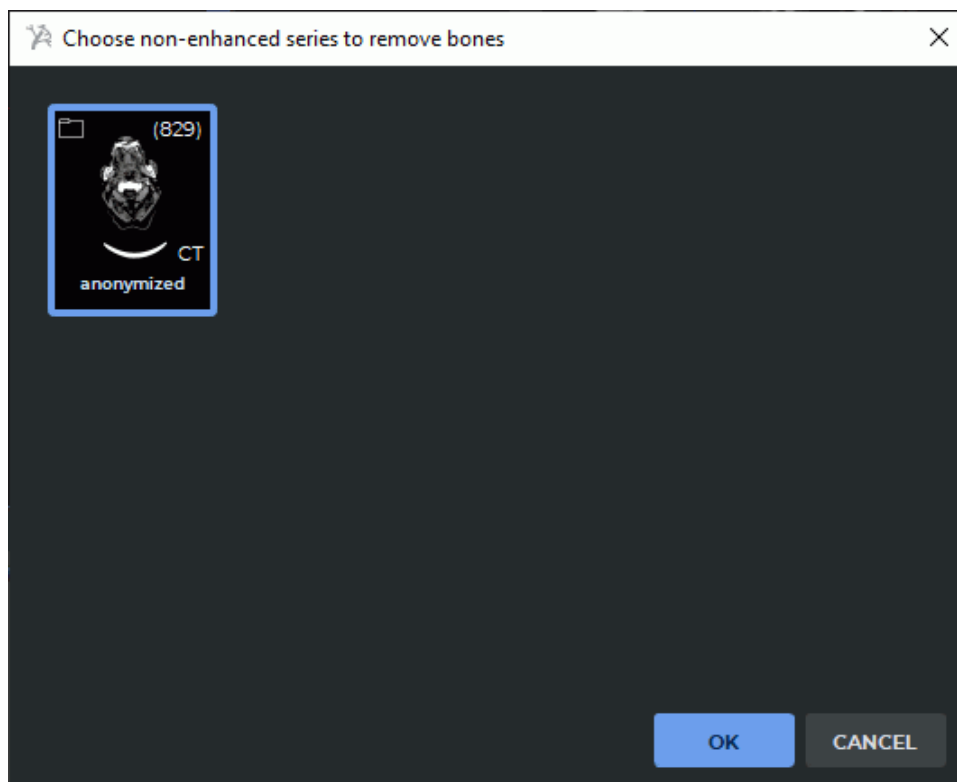

*Figure 7.1: The dialog box providing an opportunity to select a non-contrast-enhanced series for deleting bones*

In the dialog that opens, select the series without contrast and click **OK** to remove bones or **CANCEL** to cancel deletion.

If the study does not contain any series with an opportunity to delete bones, the dialog box does not pop up.

To open the bone removal dialog (Fig. 7.1) manually, click the arrow on the right side of the **New vessel**  button and select the **Subtract bones** item. The command is only available for series with CT modality. If there are no suitable series, a notification will pop up when the user selects the **Subtract bones** command.

This process takes some time.

To enable/disable the function of displaying a dialog box requesting a non-contrast-enhanced series for bones deletion when opening a study, on the main menu select the **Options->Settings...->Modules->Vessel analysis, UI** tab and check/uncheck the **Request a non-enhanced series to remove bones on window opening** box. The dialog box is displayed by default.

The vessel analysis window is shown in Fig. 7.2.

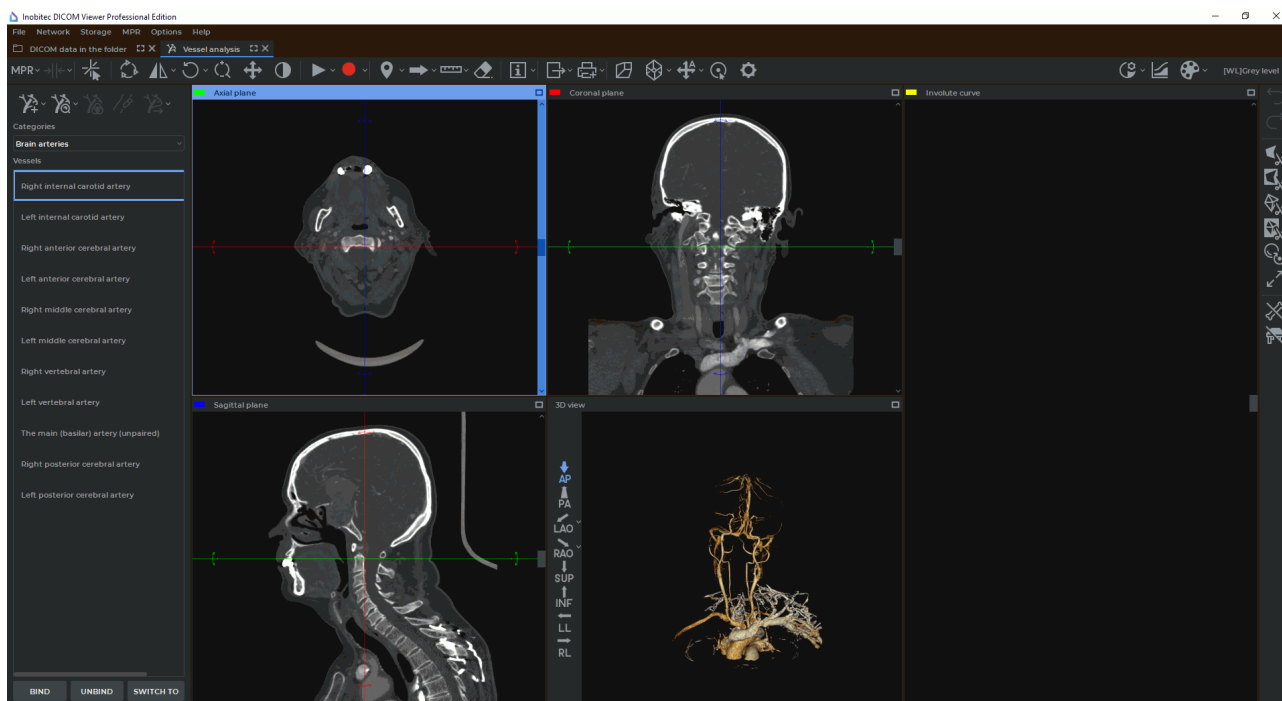





Figure 7.2: The Vessel analysis window

The windows display the axial, coronal, sagittal sections and a 3D view. In the **3D view** window, you see a 3D model and a standard space orientation panel (for details see Section 3.3). These windows are used to build the centerline. Vessel sweep is displayed in the **Involute curve** window.

To cancel rotation of all the images and the involute curve, click the **Reset views orientation**  button on the toolbar.

## 7.1.1 Vessels list

Functionality is available in a separate module which is activated in the Pro edition for an extra fee

The built centerlines can be saved on the list of vessels until the window is closed. To save the built line select the vessel category from the drop-down list **Categories** in the panel shown in Fig. 7.3; next, select the vessel below and click the **BIND** button. The  pictogram appears to the right of the selected vessel on the list. To switch to the previously saved centerline, select the vessel on the list and click the **SWITCH TO** button. To remove the centerline from the list, click the **UNBIND** button. The  pictogram disappears.



**Attention! If the current centerline is not bound to any of the vessels on the list, then when you built another line, it will be lost.**

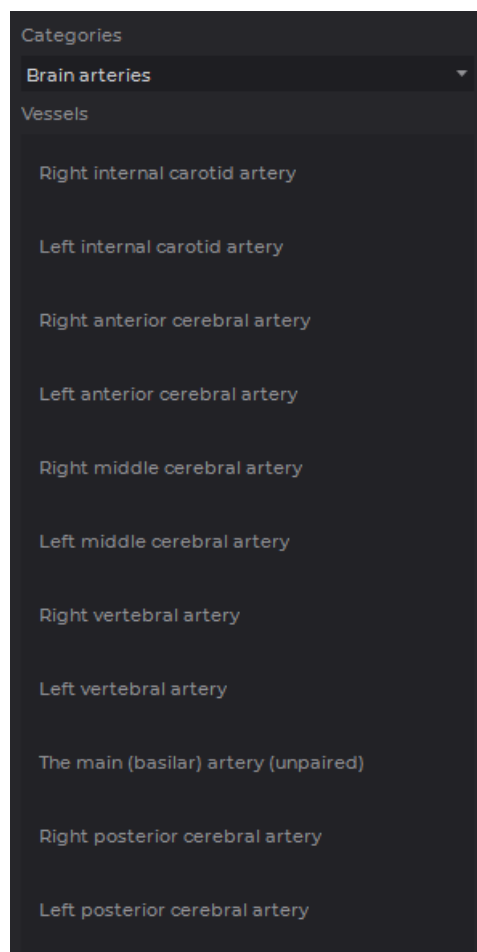



Figure 7.3: Vessel list

## 7.2 «Render settings» Tool

---

Functionality is available in a separate module which is activated in the Pro edition for an extra fee

---

The **Render settings**  tool allows for setting the rendering quality of the 3D model and the opacity threshold in the **3D view** window. The tool is available on the toolbar of the **Vessel analysis** tab and **Coronary artery analysis** tab. The operation of the tool is described in Section 3.14.

## 7.3 The Play Tool

---

Functionality is available in a separate module which is activated in the Pro edition for an extra fee

---

The tool in the MPR View windows is similar to that described in Section 2.15 and the tool in the Volume Reconstruction window is similar to that described in Section 3.7.

## 7.4 Video recording

---

Functionality is available in a separate module which is activated in the Pro edition for an extra fee

---

The DICOM Viewer allows you to record video for the MPR view, the surfaces view and the volume reconstruction view windows. The following objects will be recorded:

- tissues;
- measurements;
- annotations;
- markers;
- tags;
- orientation cube;
- the center line.

The other features of the tool in the MPR View windows are similar to those described in Section 2.15 and the features in the Volume Reconstruction window are similar to those described in Section 3.7.

## 7.5 Image Filters

Functionality is available in a separate module which is activated in the Pro edition for an extra fee



**This function cannot be used for establishing a diagnosis**

Work with filters in the **Vessel analysis** and **Coronary artery analysis** tabs is similar to work in the **Image viewer** tab (see Section 2.6) with two exceptions:

- to apply a filter in the **Vessel analysis** and **Coronary artery analysis** tabs, on the main menu, select **MPR->Filters** and select the desired filter on the list of filters on the main menu. The current filter is highlighted with blue on the list of filters, and marked with a flag;
- in the **Vessel analysis** and **Coronary artery analysis** tabs, a filter is applied to all the cutting plane windows and the involute curve window.

## 7.6 Centerline building mode

Functionality is available in a separate module which is activated in the Pro edition for an extra fee

For analysis, it is necessary to build a centerline which is automatically located in the notional center of the vessel. Only one centerline can be built at a time. To save the built line and build a new one, bind it to a specific vessel from the list in the left part of the window (see Section 7.1.1).



**You need to control the process of building the centerline and make corrections, if needed.**

### 7.6.1 Building the centerline

Functionality is available in a separate module which is activated in the Pro edition for an extra fee

You can build the centerline in two methods. To select a method click the arrow on the right side of the **New Vessel**  button and select the appropriate method (Fig 7.4). The current method is marked with a flag.

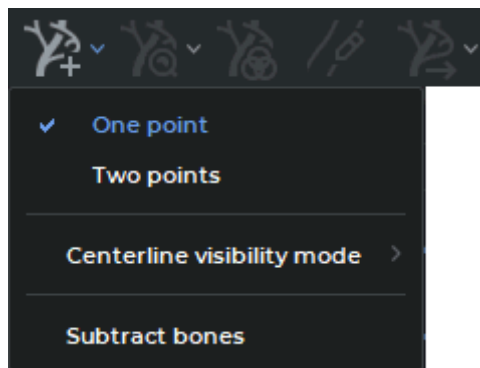



Figure 7.4: Select a method to build the centerline

1. Building by one point. In this mode the line is built in both directions from the starting point for a maximum distance. If the vessel splits along the construction line, then the line is built in an arbitrary branch. To build the line, click the left mouse button at the starting point. To extend a vessel line, left-click in the right spot. The line will be built from the closest existing point and will pass through the new point.
2. Building by two points. In this mode, the line is built from the starting point to the end point. To build the line, click at the starting and end points. The DICOM Viewer adds the required number of intermediate points to set the centerline. If the line is not completely built, then select the point up to which you want to extend the line and click in at it. The line will be built from the nearest existing point.

If the centerline for the selected points cannot be built, then the message **Unable to trace vessel centerline from this point(s)** appears.

If the line is not built correctly, then start building it again by clicking on the **New vessel**  button or edit the line.

- **Drag a point.** Locate the cursor on the center line of the vessel. The points are displayed when you hover the cursor over the center line of the vessel. Select a point on the curve you need to move. The selected point is centered in the cutting planes windows. While holding the left mouse button, move the point in the cutting planes windows. To escape from the **Drag a point** mode, left-click near the curve.
- **Add a point.** Locate the cursor on the center line of the vessel. The points are displayed when you hover the cursor over the center line of the vessel. To add a point, move the cursor to the place where you want to add a point, right-click and on the context menu and select the **Add point** command. The centerline will change so as to pass through a new point. A new point may be added to extend the centerline of a vessel.
- **Continue curve to the end of the vessel.** Locate the cursor on the center line of the vessel. The points are displayed when you hover the cursor over the center line of the vessel. To extend a curve, select the end point on the curve, right-click and select the **Trace from this tip** command on the context menu. The curve will be extended to the end of the vessel.

- **Delete part of a curve (segment).** To delete part of the line, delete a segment. The segment is deleted along with the shorter part of the line adjacent to the point. To delete a segment, right-click on the first point of the segment and select the **Remove segment** item. The shorter part of the centerline is removed from one side of the point and the section between this and the next point from the other side.
- **Delete a point.** Locate the cursor on the center line of the vessel. The points are displayed when you hover the cursor over the center line of the vessel. To delete a point, move the cursor over this point so that all the points are highlighted, right-click and on the context menu and select the **Remove point** command.

The initial research data or the volume reconstruction data can be used for building. To select the data source, click the arrow on the right side of the **New vessel**  button and select the appropriate source.

The centerline is shown in Fig. 7.5.

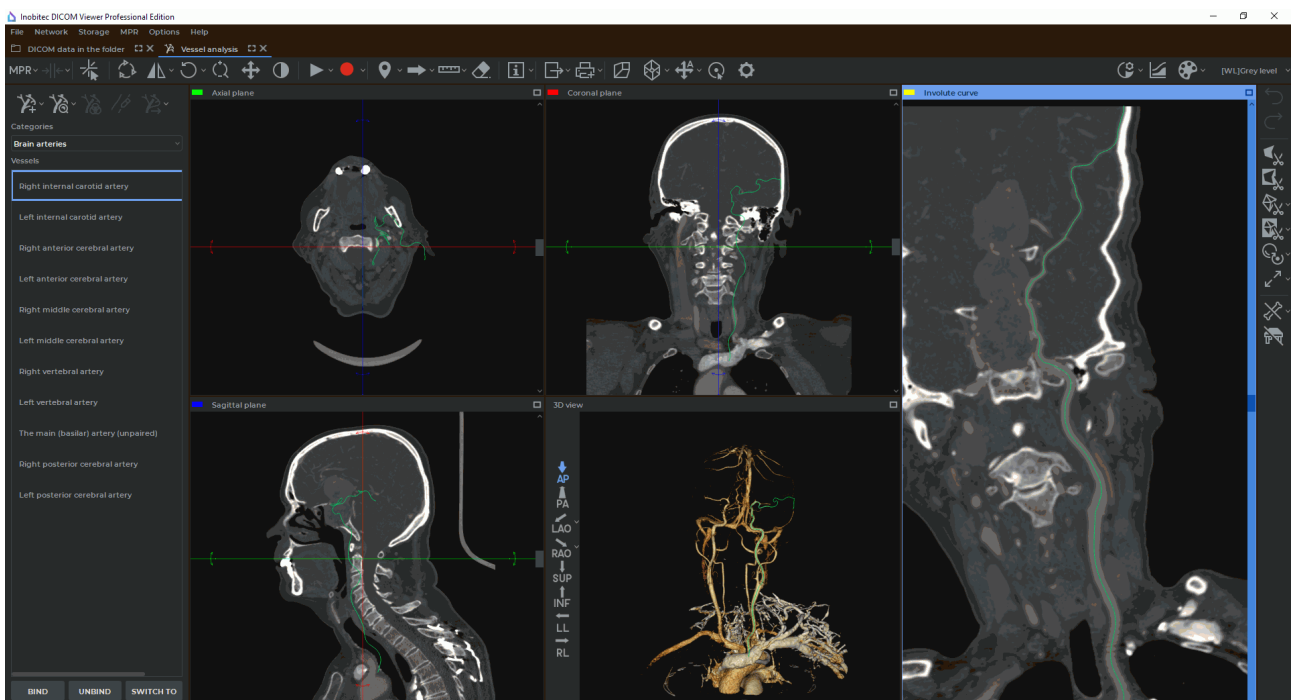



Figure 7.5: The centerline

To choose the vessel centerline visibility mode, click the arrow on the right-hand side of the **New vessel**  button and choose the **Centerline visibility mode** option (see Figure 7.6). The same command is available in the right-click menu. The current centerline visibility mode is ticked.

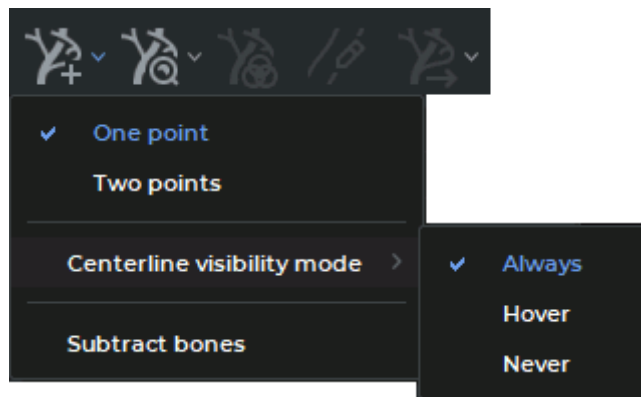

Figure 7.6: Select the vessel centerline visibility mode

- **Always.** The vessel centerline is always displayed in the **Cutting planes** windows, as well as in the **Volume reconstruction**, **Involute curve**, and **Straightened vessel** windows. If you mouse over the centerline, you will see the points.
- **Hover.** The vessel centerline is always displayed only in the **Volume reconstruction** window. The vessel centerline is displayed in the **Cutting planes** windows, as well as in the **Straightened vessel** and **Involute curve** windows if you mouse over it or select one of the points.
- **Never.** The vessel centerline is always displayed only in the **Volume reconstruction** window. It is not displayed in any other windows.

The vessel centerline visibility settings will be applied next time you open the Vessel analysis window.

## 7.7 Vessel Analysis Mode

---

Functionality is available in a separate module which is activated in the Pro edition for an extra fee

---

After building the necessary centerlines, switch to the Vessel analysis mode by clicking on the **Analysis mode**  button. The window in the Vessel analysis mode is shown in Fig. 7.7.



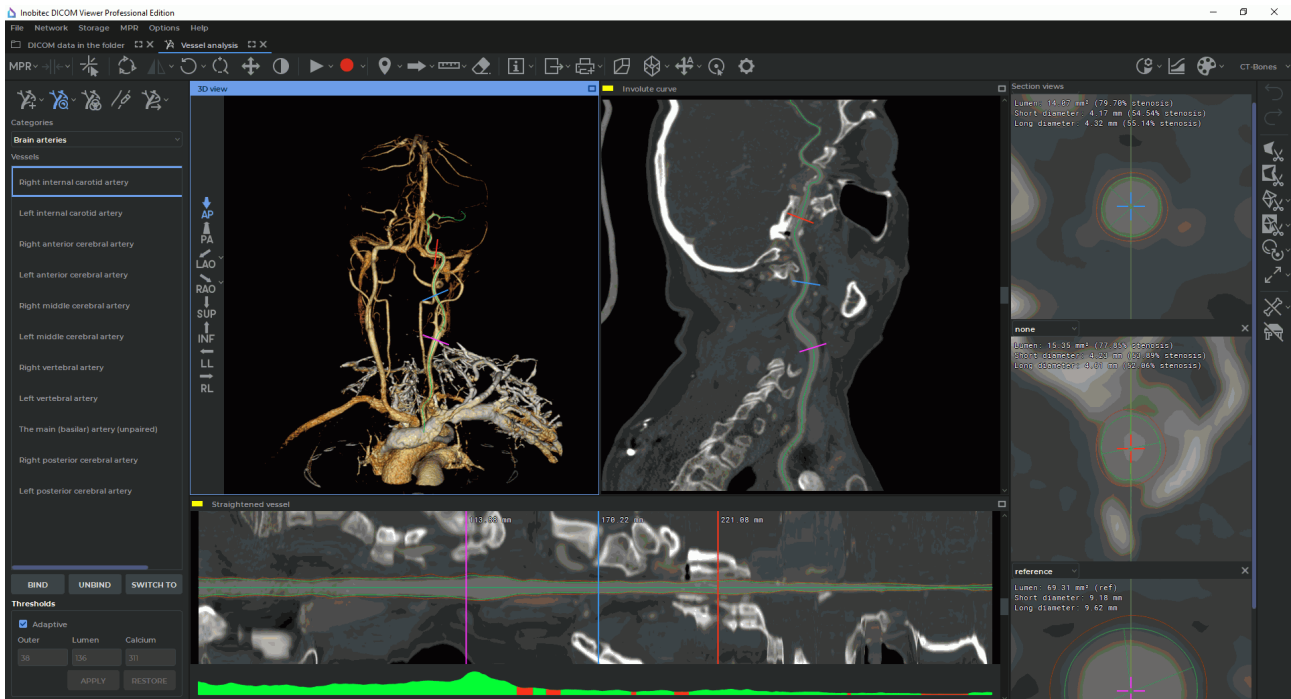

Figure 7.7: The vessel analysis mode

The volume reconstruction is shown in the **3D view** window, the curved surface is shown in the **Involute curve** window. The vessel sweep following the straightening of its centerline and the marking of its borders is shown in the **Straightened vessel** window. The sections by the planes that are perpendicular to the centerline are shown in the **Section** window.

You cannot edit the centerline in the Vessel analysis mode. To do it switch to Centerline building mode by clicking the **Analysis mode**  button.

## 7.7.1 Vessel borders

Functionality is available in a separate module which is activated in the Pro edition for an extra fee

The DICOM Viewer calculates the inner and outer borders of a vessel and the border of calcifications inside a vessel (Fig. 7.9). If no calcifications are found, then the corresponding value remains empty.

If the **Adaptive** box is checked, threshold density values will be evaluated for each vessel section individually. This ensures more accurate display of contours of vessels and calcifications. The box is checked by default.

To see the tissues that correspond to the density ranges, click the **Show vessel tissue**  button. In the **Section views** window the tissues with an intensity between the inner border and the calcium border (vessel lumen) are highlighted in green, the tissues with an intensity between the outer and inner border (vessel wall) are highlighted in brown, and the tissues with an intensity higher than the calcium border (calcifications) are highlighted in white. The

borders of the vessel are built in accordance with the threshold values, but due to certain smoothing they do not exactly correspond to the threshold values. In the **Straightened vessel** window, the green line indicates the inner border of the vessel, the red line indicates the outer border (fig. 7.10).

If the **Adaptive** box is checked on the threshold value panel, then threshold density values are only highlighted in the **Section views** window as in this case threshold density values are evaluated for each vessel section individually. If the **Adaptive** box is unchecked, threshold density values are also highlighted in the **Straightened vessel** window.

The central line is shown as a straight line.

To edit borders, activate the  **Edit vessel contours** tool, click the left mouse button at an arbitrary place near the border, the border will pass through the selected point. When you move the mouse while holding the left button, the border repeats the path of the cursor.



**You need to control the process of boundaries creation, as well as the threshold boundary and calcification values. If needed, change the boundaries and the threshold values manually.**

To choose a visibility mode for vessel contours, press the arrow on the right-hand side of the **Analysis mode** button  and select the **Contours visibility mode** command (Fig. 7.8). The same command is available in the right-click menu if the vessel analysis mode is active. The current contours visibility mode is ticked.

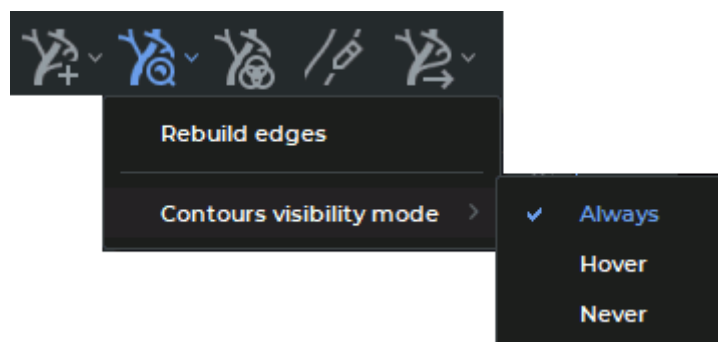

Figure 7.8: Select the contours visibility mode

- **Always.** Vessel contours are constantly displayed in **Section views** and **Straightened Vessel** windows. The mode is selected by default.
- **Hover.** Vessel contours are displayed in **Section views** and **Straightened Vessel** windows when the user hovers over the contours.
- **Never.** Vessel contours are not displayed in any windows of the tab.

To change the threshold values, uncheck the **Adaptive** box and enter new values in the appropriate fields and click the **APPLY** button. The border will be rebuilt in accordance with the new values. To return to the threshold values calculated automatically, click the **RESTORE** button.

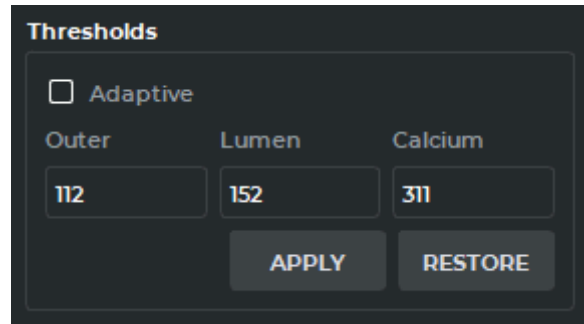



Figure 7.9: Threshold value panel

To undo all changes and return to the initial borders, click on the arrow on the right side of the **Analysis mode** button  and select the **Rebuild edges** command.

At the bottom of the **Straightened Vessel** window, there is a graph showing changes in the vessel lumen. The areas in which stenosis is possible are highlighted in red on the graph, the remaining sections are highlighted in green.

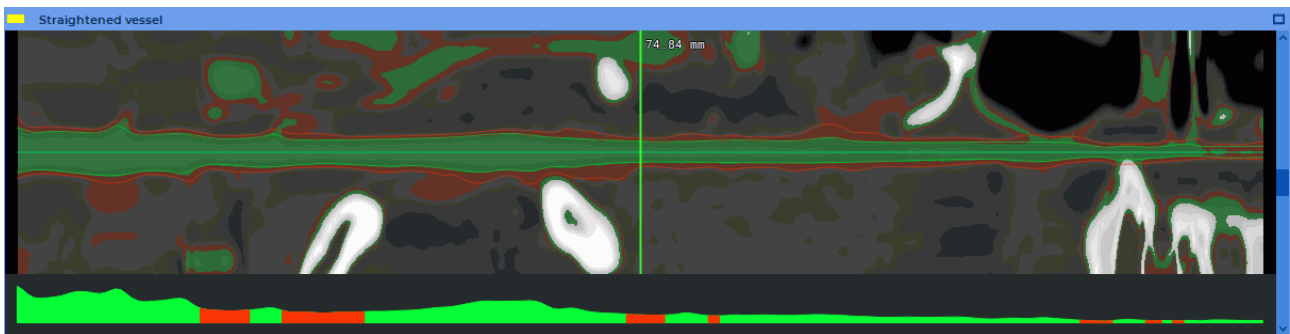

Figure 7.10: Highlighted density thresholds

## 7.7.2 Section analysis

Functionality is available in a separate module which is activated in the Pro edition for an extra fee

To add a section, move the cursor to the centerline in the **Involute curve**, **Straightened vessel** or **3D view** window, right-click and select the **Add section** command or **Add reference** to add a reference section.

To delete a section, select the **Remove section** command on the context menu of the section or click on the cross in the upper right-hand corner of the current section window (Fig. 7.11).

The position of the cross on the section corresponds to the position of the centerline.

The borders are outlined by the green and red lines. When editing borders in the current section window (Fig. 7.11), the  **Edit vessel contours** tool can be deactivated.

The yellow line in the current section window shows the cutting plane for the current section shown in the **Straightened vessel** window. To rotate the cutting plane, move the cursor over it so that a bidirectional arrow appears, hold the left mouse button and move the mouse.

The following parameters are calculated in the section view windows:

- **Lumen**
- **Short diameter**
- **Long diameter**

with the percentage of stenosis.

If you set one section as a reference, then the diameter and lumen values for the other sections are relative to the corresponding values for the reference section. If you set two sections as a reference, then the values for the other sections are relative to the average values for the reference sections. It is recommended to locate the reference sections on both sides of the section of interest if the vessel narrows. To set the type of the section, select it from the drop-down list in the upper left-hand corner of the section view window (Fig. 7.11).

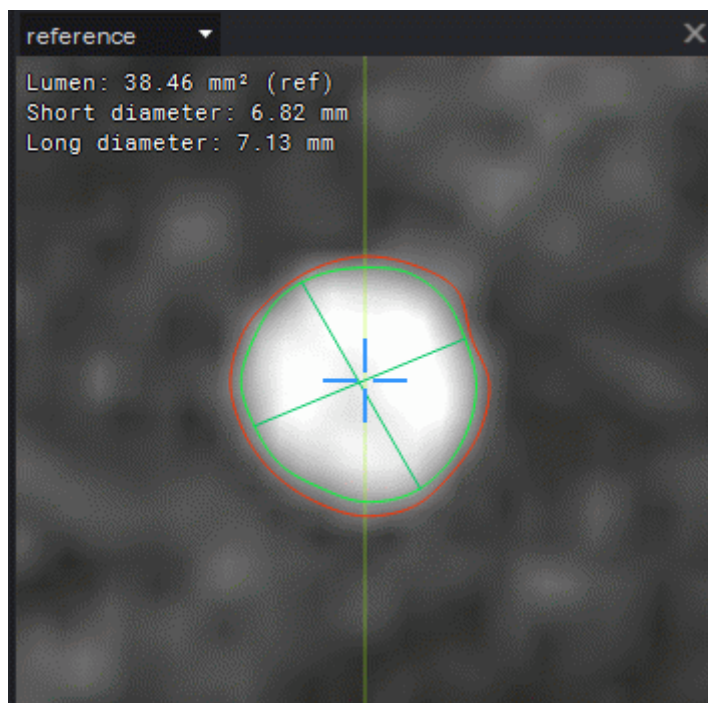

Figure 7.11: Section view window

### 7.7.3 Curved surface analysis

Functionality is available in a separate module which is activated in the Pro edition for an extra fee

A vessel sweep is displayed in the **Involute curve** and **Straightened vessel** windows.

The **Straightened vessel** window displays the distance from the beginning of the vessel to the cross section.

To analyze the vessel interval, select this interval in the **Straightened vessel** window. To do this, move the cursor to the beginning of the interval and move the mouse to the end of the interval, holding down the left mouse button, then release the button. The built interval is shown in Fig. 7.12. The borders of the interval are displayed as white sections.

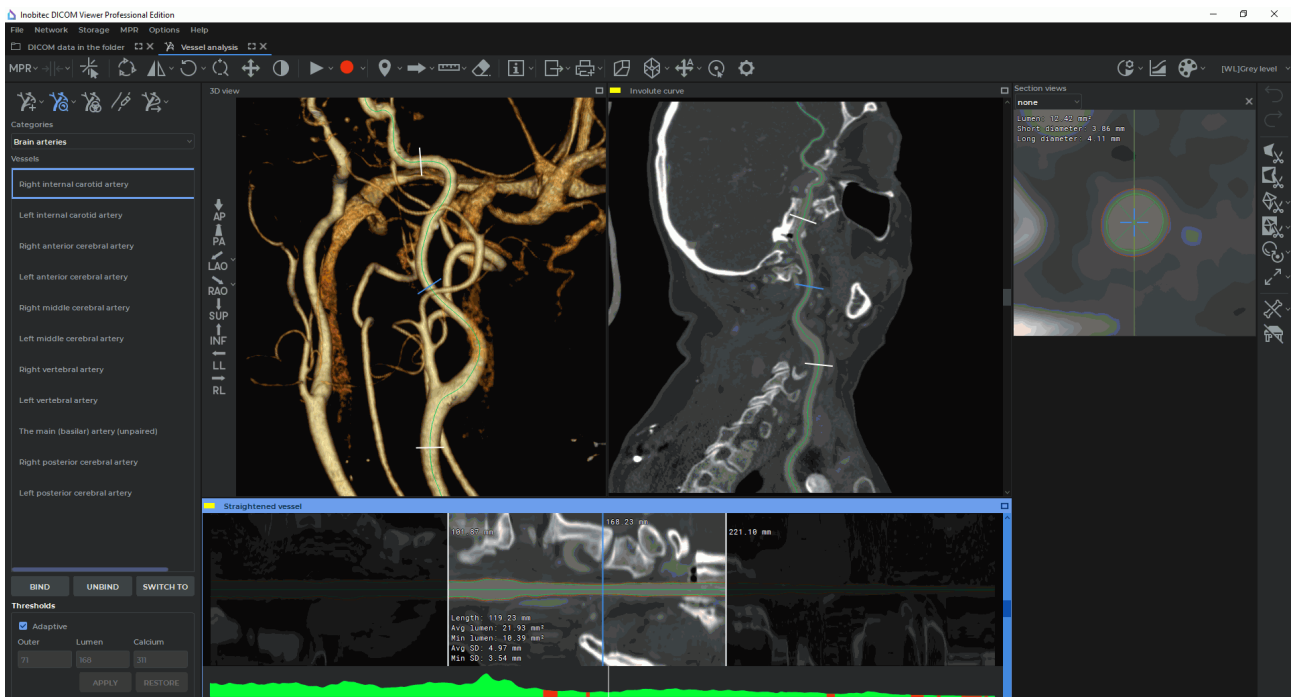

Figure 7.12: Vessel interval

The following parameters are calculated for the interval:

- Length;
- Avg lumen;
- Min lumen;
- Avg SD;
- Min SD.

To move the interval border, move the cursor to the corresponding white section in any of the **3D view**, **Involute curve** or **Straightened vessel** windows and move it with the mouse while holding down the left button. To delete an interval, click the left mouse button at an arbitrary place in the **Straightened vessel** window. To build multiple intervals, build them holding down the **Ctrl** button on the keyboard.

## 7.7.4 Export vessel surface mesh

---

Functionality is available in a separate module which is activated in the Pro edition for an extra fee

---

To export the vessel surface to a file, click on the **Export vessel surface mesh**  button, in the dialog that opens, select the file type (ply, obj or stl) and save the surface.

To close the ends of the vessel, click on the arrow on the right side of the **Export vessel surface mesh**  button, select the **Export parameters...** item and in the dialog that opens, check the **Close sides** box.

## 7.8 Coronary Artery Analysis

---

Functionality is available in a separate module which is activated in the Pro edition for an extra fee

---



**In Coronary Artery Analysis window, diagnosis can only be established on the basis of CT series. The anomalies detected should be studied using the original images in the Image Viewer window.**

The DICOM Viewer contains the Coronary Artery Analysis Module to analyze the coronary vessels. Its functionality is basically the same as that of the Vessel Analysis module.

An advantage of the Coronary Artery Analysis module is the automatic detection of the aorta. The central line of the coronary artery is cut off at the entrance to the aorta.

The features of the Coronary Artery Analysis module are:

1. Only the CT series are suitable for analysis.
2. The module does not contain the bone subtraction functionality.
3. Only coronary arteries are available on the vessel list.

To open a series in the Coronary Artery Analysis window, click the **Coronary Artery Analysis**  button on the toolbar. To select the tab location (in the current window, in a separate window or in the full screen mode), click on the arrow on the right side of the button. To open the Coronary Artery Analysis window in a new tab in the current window, click on the button. The process may take some time.

The **Coronary artery analysis** tab comprises the windows with Axial, Coronal, and Sagittal plane sections, as well as the **3D view** window. In the **3D view** window, you see a 3D model and a standard space orientation panel (for details see Section [3.3](#)). In the **Involute curve** window, the vessel involute is displayed.

# Chapter 8

## Cardiac function analysis

---

Functionality is available in a separate module which is activated in the Pro edition for an extra fee

---

The module is intended for providing ventricular function quantification on the basis of a set of short axes by way of contouring the region of interest (ROI). Contours may be built in the manual and the semi-automatic mode. The ventricular parameters are evaluated on the basis of the contours built.



**Left ventricular function analysis based on Simpson's rule is performed for MR modality series with images oriented along the short axis of the heart.**

### 8.1 Opening Studies in the Cardiac Function Analysis Module

---

Functionality is available in a separate module which is activated in the Pro edition for an extra fee

---

To open a study in the cardiac function analysis module, proceed as follows:

1. Choose a study and select **MR** series with images oriented along the short and long axis of the heart. In some cases, you don't have to select series with images oriented along the long axis of the heart. For details on selecting series, see Section 1.10.
2. Click the **Cardiac function analysis**  button on the toolbar. To select the tab location (in the current window, in a separate window, or in the full-screen mode), press the arrow on the right-hand side of the button. To open the cardiac analysis window in a new tab in the current window, press the button. The process may take some time.

The **Cardiac function analysis** tool is also available in the **View** section of the main menu.





If you haven't provided all the required parameters in the **Input data for cardiac function analysis** dialog box (see Fig. 8.1), the **OK** button will be deactivated.

In the **Cardiac function analysis** tab, you can see two windows, with the SAX merged series and the LAX merged series (Fig. 8.2). The toolbar for cardiac function analysis is on the right-hand side of the tab.

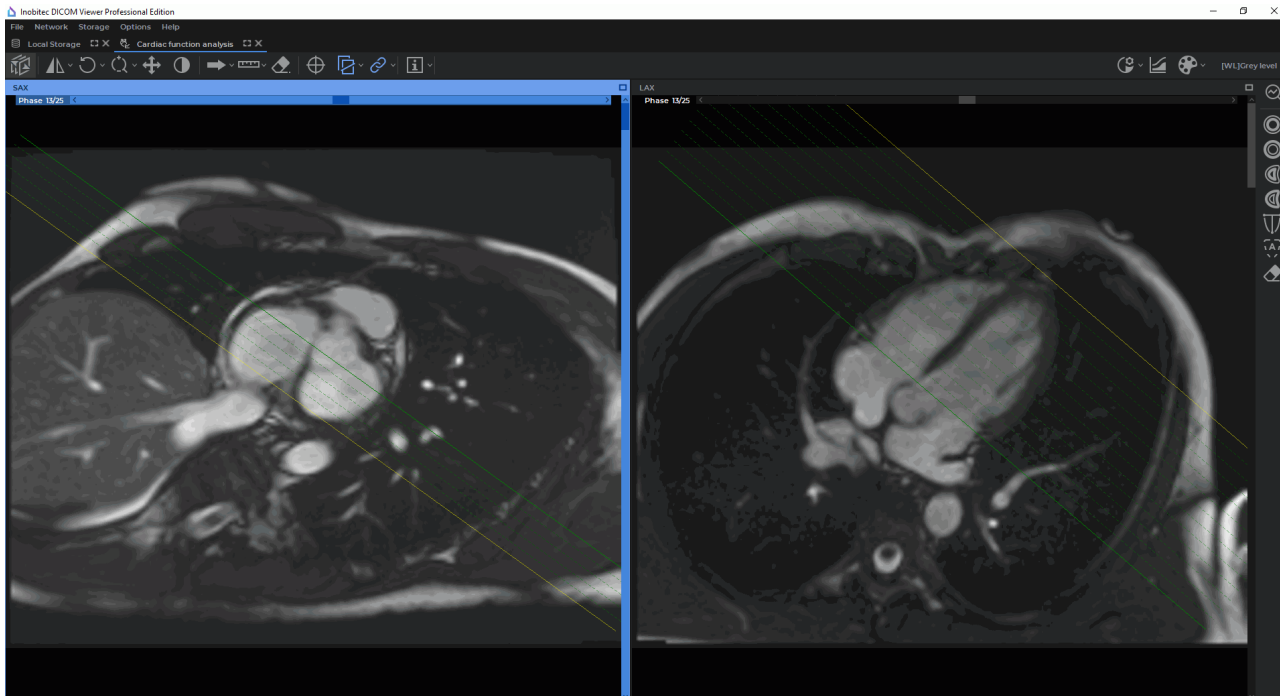



Figure 8.2: Cardiac function analysis tab







## 8.2 Tools for Cardiac Function Analysis

Functionality is available in a separate module which is activated in the Pro edition for an extra fee

The toolbar for cardiac function analysis is on the right-hand side of the **Cardiac function analysis** (Fig. 8.2).

Tools:

	<p>The <b>Endocardial LV contour</b> button is aimed for building and editing the inner contour of the left ventricle manually (the contour is shown in red)</p>
	<p>The <b>Epicardial LV contour</b> button is aimed for building and editing the outer contour of the left ventricle manually (the contour is shown in yellow)</p>

	The <b>Endocardial RV contour</b> button is aimed for building and editing the inner contour of the right ventricle manually (the contour is shown in dark-blue)
	The <b>Epicardial RV contour</b> button is aimed for building and editing the outer contour of the right ventricle manually (the contour is shown in light-blue)
	The <b>LV extension boundaries</b> button is aimed for manual determination of the left ventricle extension boundaries along the long axis (see Section 8.3.2)
	The <b>Auto contouring</b> button activates the process of automatic contouring of the left ventricle endocardium end epicardium (see Section 8.3.3)
	The <b>Remove all cardiac contours</b> button deletes all the contours built manually or automatically (see section 8.3.4)
	The <b>Start analysis</b> button triggers the analysis process and opens a panel with all the results of functional parameters evaluation (see Section 8.4)
	The <b>Edit</b> button closes the panel with the results and opens the toolbar for cardiac function analysis to provide an opportunity to build and edit contours

## 8.3 Building Contours

Functionality is available in a separate module which is activated in the Pro edition for an extra fee

The functional parameters of the left and the right ventricles are calculated on the basis of the contours built. Contours can be built separately for each slice and phase in the window with the SAX merged series. The contour boundaries are shown as points on the slices in the window with the merge LAX series. If two or more contours were built for one phase, the points can be connected by segments. You cannot build contours in the window with a LAX merged series.

To simplify the process of building contours, we recommend enabling the display of slices scout lines in the window selected (see Section 2.25).





### 8.3.1 Building Contours Manually

---

Functionality is available in a separate module which is activated in the Pro edition for an extra fee

---

You can use the following tools to build contours manually:

- **Endocardial LV contour**  ;
- **Epicardial LV contour**  ;
- **Endocardial RV contour**  ;
- **Epicardial RV contour**  .

The choice of the tool depends on the region of interest and the results of the analysis required.

To build a contour, proceed as follows:

1. Open the study in the **Cardiac function analysis** tab (see Section 8.1).
2. Activate one of the contour building tools with the left, right, or middle mouse button. To continue work with the same tool, use the button with which the tool was activated. For details on tool management, see Section 1.14.  
Build the contour in one of the following ways:
  - **building contours manually.** In the window with the SAX merged series, build a contour around the selected area while holding the button with which the tool was activated. To complete the contour, release the mouse button. To cancel the contour that has not been closed, click **Esc** on the keyboard while holding the mouse button;
  - **building contours with an isoline.** Move the cursor around the selected area while holding the **Shift** button on the keyboard and the mouse button with which the tool was activated. Under the cursor, you will see an isoline. You can see an isoline only on the slices where a contour can be built. To build a contour with an isoline, release the mouse button with which the tool was activated.
3. Go to the next slice and contour the selected area.
4. After you have built the required contours, click the **Start analysis**  button to go to the results of parameters assessment (see Section 8.4).

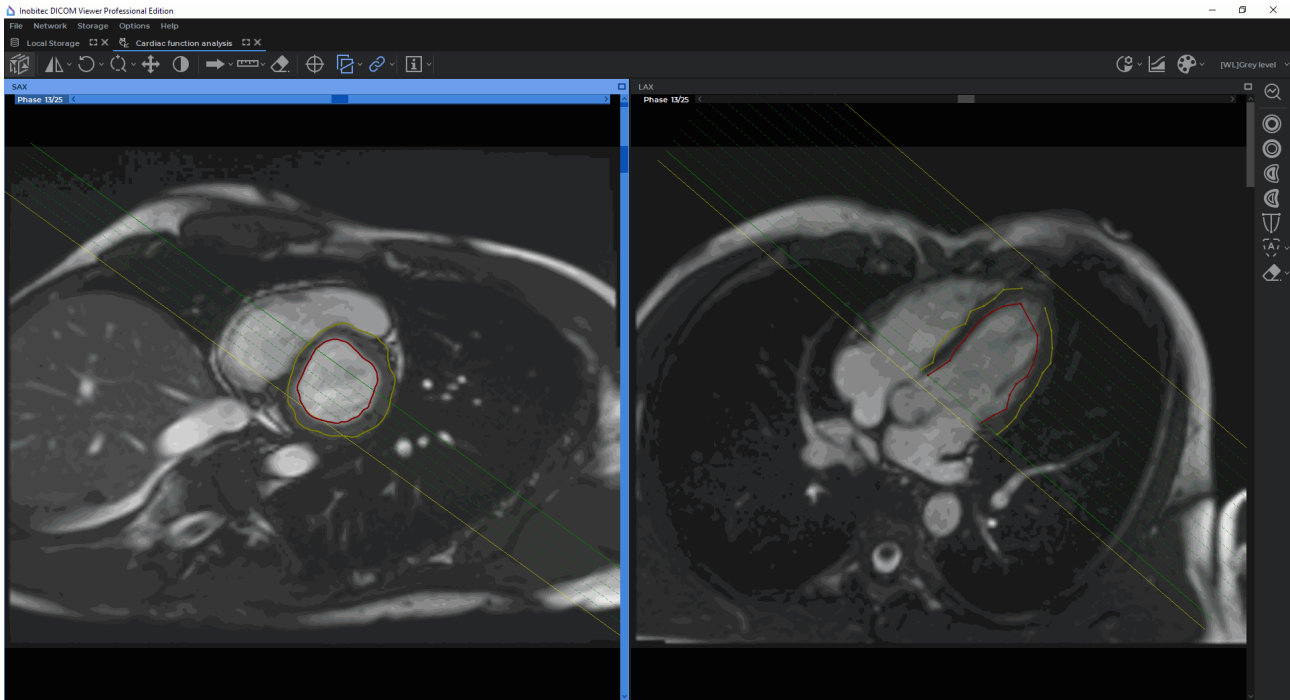

*Figure 8.3: The Left ventricle epicardium and endocardium contours are shown in the SAX window, and the contour boundaries on the slices are shown in the LAX window*

If there is a contour built with the current tool on the current slice, you cannot build a new contour here. You can only edit or delete the existing contour (see Section 8.3.4).

### 8.3.2 Evaluating the Left Ventricle Extension

Functionality is available in a separate module which is activated in the Pro edition for an extra fee

To evaluate the left ventricle extension, you need the SAX and the LAX merged series to be loaded to the **Cardiac analysis** tab (see Section 8.1).

To evaluate the left ventricle extension, proceed as follows:

1. Open the study in the **Cardiac function analysis** tab (see Section 8.1).
2. Activate the **LV extension boundaries**  tool with the left, right, or middle mouse button. To continue work with the same tool, use the button with which the tool was activated. For details on tool management, see Section 1.14.
3. In the window with the SAX merged series, choose the slice for the upper plane of the mitral valve and mark a point in the center of the mitral valve.
4. Go to the slice corresponding to the left ventricular apex and mark a point in the center of the apex.

When you mouse over a point in the window with the SAX merged series, you see a pop-up tip with the type of the point, *Mitral* or *Apex*.

In the window with the LAX merged series, the left ventricle extension is marked with a line (Fig. 8.4).

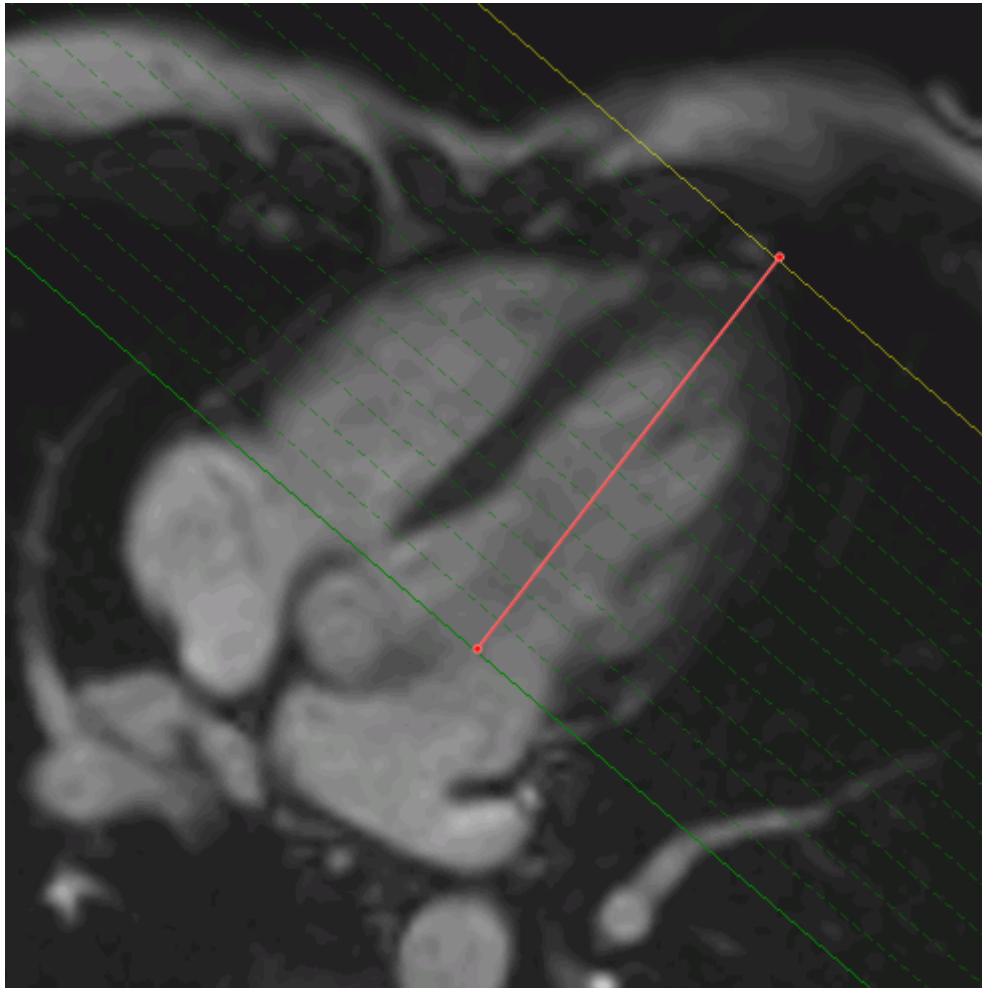

*Figure 8.4: Left ventricle extension shown in the window with the LAX merged series*

In multiphase series, the left ventricle extension may be determined for each phase.

### **8.3.3 Contouring the Left Ventricle Endocardium and Epicardium Automatically**

---

Functionality is available in a separate module which is activated in the Pro edition for an extra fee

---

To contour the left ventricle endocardium and epicardium automatically, proceed as follows:

1. Open the study in the **Cardiac function analysis** tab (see Section 8.1).
2. Determine the left ventricle extension (see Section 8.3.2) for the End Diastole (ED) and End Systole (ES) phases.
3. Click the **Auto contouring**  button on the toolbar for cardiac function analysis.

Automatic contouring of the left ventricle endocardium and epicardium are performed in the window with the SAX merged series for all the phases with the left ventricle extension and all the slices within the extension. The contour boundaries are shown on the slices in the window with the LAX merged series (Fig. 8.5).

The program algorithm builds the epicardium contour on the basis of the left ventricle endocardium contour. If the program fails to build the endocardium contour on a slice or if an error is made while contouring, it will be impossible to build the epicardium contour on this slice or a similar error will be made.



**Attention! If a part of the atrium is present on the mitral valve slice, it may be captured while contouring.**

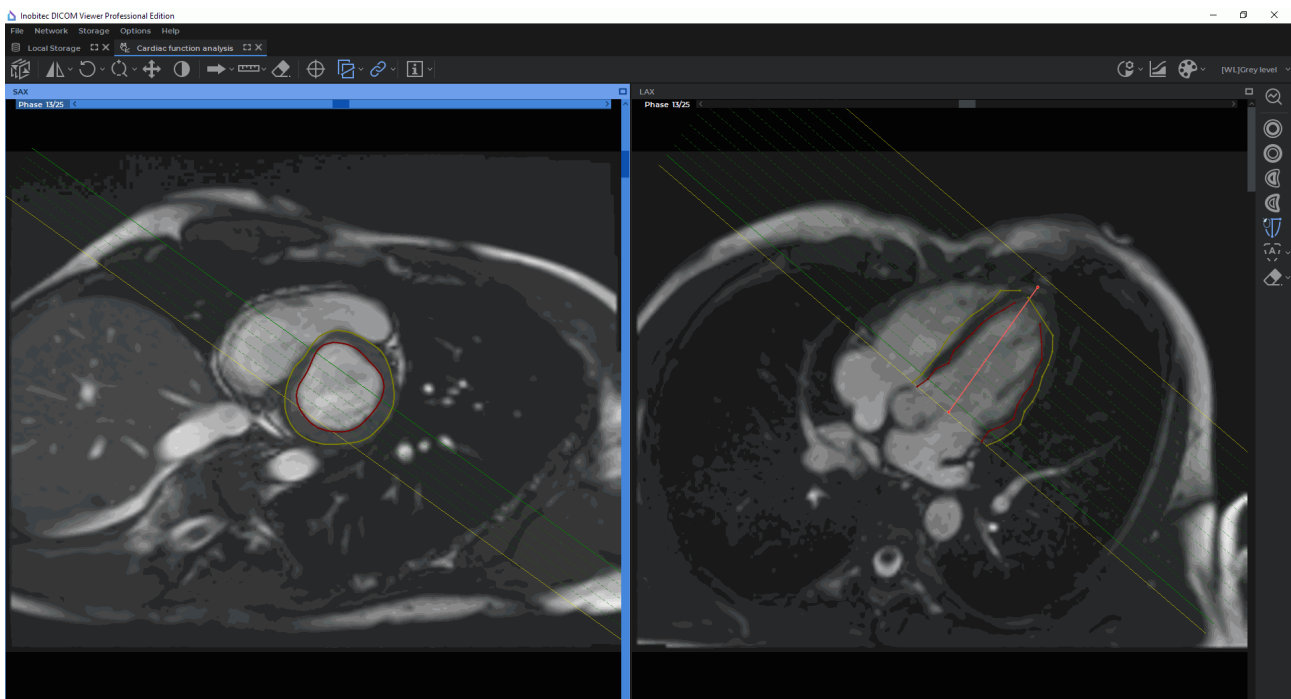



Figure 8.5: Automatic contouring of the left ventricle

To rebuild all the contours, press the arrow on the right-hand side of the **Auto contouring**  button and select **Rebuild contours**.



**During automatic contouring, it is possible that tissues may be captured by the contour in error. Check that the contours are drawn correctly and edit the contours manually if necessary.**

To go to the results of parameters assessment, click the **Start analysis**  button (see Section 8.4).



### 8.3.4 Actions with Contours

---

Functionality is available in a separate module which is activated in the Pro edition for an extra fee

---

The DICOM Viewer provides an opportunity to perform the following actions with contours:

- **editing.** Mouse over the selected contour. When the cursor is placed on the contour, the contour is highlighted. Click the mouse button in the place where you want to edit the contour and build a new contour while holding the mouse button. To complete the contour, release the mouse button;
- **deleting a contour.** Mouse over the selected contour, click the right mouse button, and select the **Remove contour** option on the context menu;
- **deleting all the contours of the same type.** Click the arrow on the right-hand side of the **Remove all cardiac contours**  button. On the menu, select the type of contours you want to delete from all the slices;
- **deleting all the contours.** To delete all the contours, click the **Remove all cardiac contours**  button. All the contours on all the slices in the window with the SAX merged series will be deleted;
- **deleting the extension boundaries.** Place the cursor on one of the points used for evaluating the LV extension. The point will be highlighted. Click the right-hand mouse button and select the **Remove extension boundaries** option on the context menu.

## 8.4 Evaluating Functional Parameters of the Heart

---

Functionality is available in a separate module which is activated in the Pro edition for an extra fee

---

To evaluate functional parameters of the heart, proceed as follows:

1. Open the study in the **Cardiac function analysis** tab (see Section 8.1).
2. Build the required contours manually or automatically (see Section 8.3).
3. Click the **Start analysis**  button on the toolbar for cardiac function analysis.

The results of functional parameters evaluation and the information on the patient are presented as a table. The following basic parameters for the left and the right ventricle are evaluated:

- **EDV** (end diastolic volume), the maximum ventricle cavity volume at the end of diastole, measured in *ml*. To evaluate the parameter, you need to build the endocardial contours;



- **ESV** (end systolic volume), the minimum ventricle cavity volume at the end of contraction (systole), measured in *ml*. To evaluate the parameter, you need to build the endocardial contours;
- **SV** (stroke volume), the volume of blood ejected with each heart beat, measured in *ml* and calculated by the **SV = EDV – ESV** formula. To evaluate the parameter, you need to build the endocardial contours;
- **EF** (ejection fraction), the percentage of blood ejected with each heart beat calculated by the **EF = SV/EDV** formula. To evaluate the parameter, you need to build the endocardial contours;
- **CO** (cardiac output), the amount of blood pumped in a minute, measured in *l/min* by the **CO = SV \* heart rate** formula. To evaluate the parameter, you need to build the endocardial contours and know the heart rate;
- **CI** (cardiac index), the cardiac output related to the body surface area (BSA). The parameter is measured in  $\frac{l}{(m^2 * min)}$  and calculated by the **CI = CO/BSA** formula. The body surface area (BSA) is calculated by the following formula:  $BSA = 0.007184 * W^{0.425} * H^{0.725}$ , where W is the patient's weight in kilos and H is the patient's height in centimeters. To evaluate the parameter, you need to build the endocardial contours and know the patient's weight and height;
- **Myocardial mass**, shows the difference in the epicardium and endocardium volumes at the end of diastole (ED) and systole (ES) multiplied by a factor of 1.05, measured in g. To evaluate the parameter, you need to build the endocardial and epicardial contours for the ED and ES phases.

The results of functional parameters evaluation can be copied to the clipboard and then inserted in the report editor (see Chapter 18) or in any text editor. To copy the results of functional parameters evaluation to the clipboard, click the **EXPORT TO CLIPBOARD** button.

The coordinate system (Fig. 8.6) shows the functional parameters for all the phases as graphs. On the x- axis, you can see the time in milliseconds while on the y- axis the blood volume is shown in milliliters.



**Attention! Graphs are built on the basis of the contours created for each slice of each phase in the window with the SAX merged series.**

The coordinate system shows the heart functional parameters as graphs:

- left ventricle endocardium volume **LV blood** (red line);
- left ventricle myocardium volume **LV myocardial** (yellow line);
- right ventricle endocardium volume **RV blood** (dark blue line);
- right ventricle myocardium volume **RV myocardial** (light blue line).

The measurement results are shown as a table on the right-hand side of the coordinate plane. The values of the parameters reflect the measurement results for the current point.

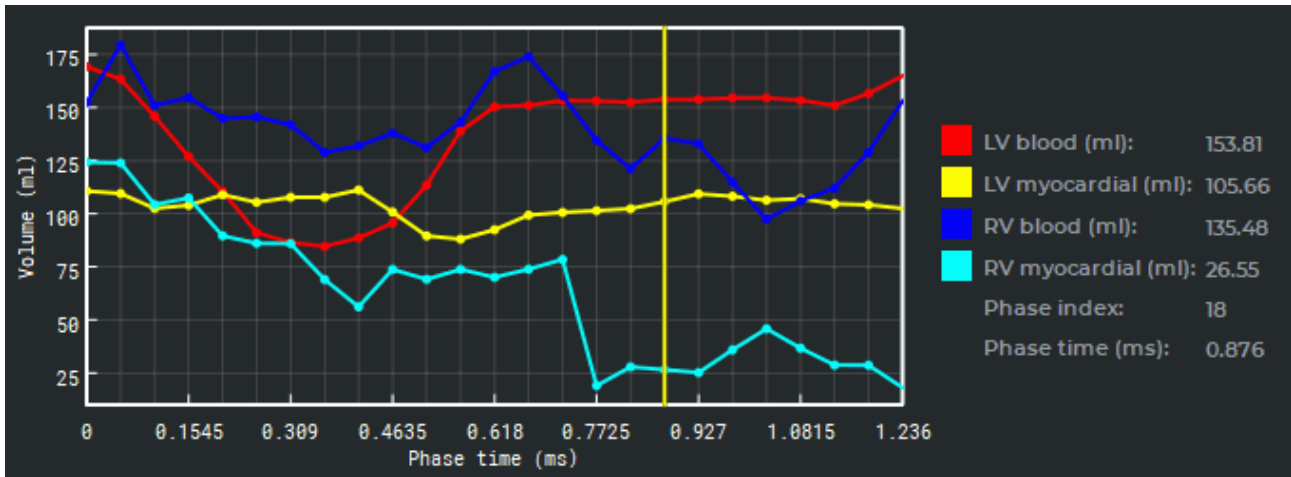

Figure 8.6: Heart functional parameters shown as graphs

The position of the current phase is marked with the yellow slider. To change the current phase on the graph, mouse over the slider so that the cursor takes the  $\leftrightarrow$  shape. Holding the left mouse button, move the slider to the left or to the right. When you move the slider, the current phase in the window with the SAX merged series is changed simultaneously. When the current phase is changed, the measurement results shown in the table next to the graphs are also changed.

To move the graph along the y-axis, move the mouse up and down while holding the left mouse button and the **Shift** key on the keyboard. To scale the graph, move the mouse up and down while holding the left mouse button and the **Ctrl** key on the keyboard.

To edit the information on a patient, click the **EDIT PATIENT INFO** button and make the necessary corrections in the dialog box (Fig. 8.7). Click **OK** to apply the new data or **CANCEL** to cancel. After you click the **OK** button, the results of functional parameters analysis will be reevaluated.

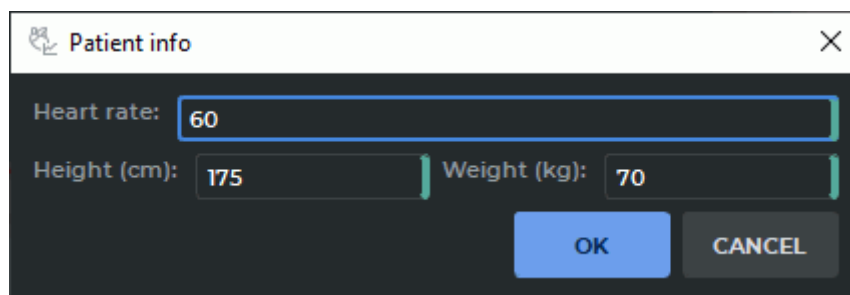



Figure 8.7: Dialog box for editing the information on a patient

To get back to the contour building and editing mode, click the **Edit**  button.

---

# Chapter 9

## PET analysis

---

Functionality is available in a separate module which is activated in the Pro edition for an extra fee

---

### 9.1 Open Studies in PET Analysis tab

---

Functionality is available in a separate module which is activated in the Pro edition for an extra fee

---

To open a study:

1. Load studies to the DICOM Viewer.
2. Select a study containing at least one CT and one PET series.
3. Select one CT and one PET series by clicking the left mouse button while holding down the **Ctrl** key on the keyboard.
4. Click the **PET analysis**  button on the toolbar. To select the tab location (in the current window, in a separate window or in the full screen mode), click on the arrow on the right side of the button. To open the study in a new tab in the current window, click on the button **PET analysis**. The process may take some time.
5. Choose a windows arrangement template for the required number of series (see Sections [9.2.1](#) and [9.2.2](#)).

The DICOM Viewer displays data in the following modes:

- 3D MIP (Maximum Intensity Projection) for the PET series (**3D MIP** mode);

- Original CT series (**CT** mode);
- Original PET series (**PET** mode);
- Fused CT + PET series (**Fusion (PET+CT)** mode). The image displayed in the window is the same as in the fused series window (see Chapter 4).

The PET analysis window is shown in Fig. 9.1.

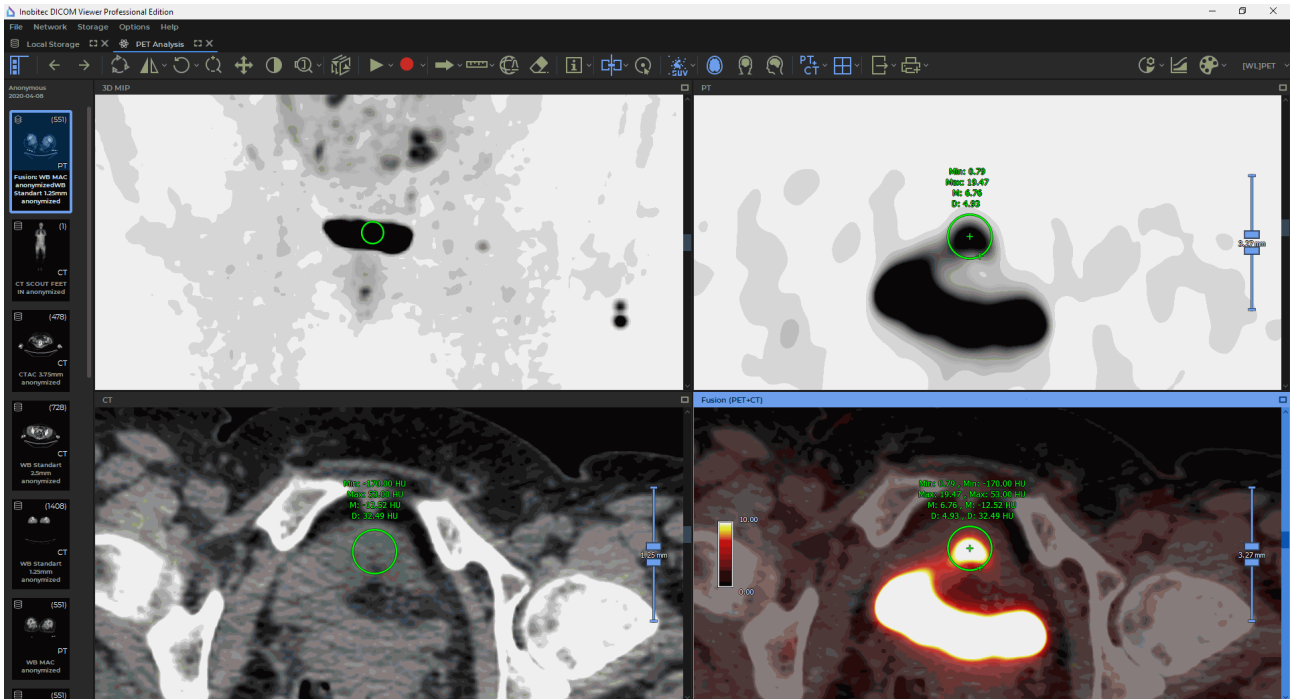



Figure 9.1: PET analysis window

## 9.1.1 Fuse series from the same study in the PET analysis tab

Functionality is available in a separate module which is activated in the Pro edition for an extra fee

To fuse series of one study, proceed as follows:

1. Open the study in the PET analysis tab (see Section 9.1).
2. On the series panel of current study select the series required by left-clicking on them while holding down the **Ctrl** key.
3. Drag the series to the window you need. If the series may be dragged to this window, the cursor will have the shape of . If it is impossible to drag the series to this window, the cursor will have the shape of . In this case, choose another window or change the display mode in this window (Section 9.2.1). Release the mouse button. The series (fused series) will be opened in this window.

4. If needed, repeat the actions described in points 2-3 for other series.

### 9.1.2 Fuse series from different studies in the PET analysis tab



Functionality is available in a separate module which is activated in the Pro edition for an extra fee

The DICOM Viewer allows you to fuse series from different studies in the PET analysis tab, e.g. to monitor the changes. If the studies differ in the following parameters:

- the patient's name (not case sensitive) (tag (0010,0010));
- the patient's ID (tag (0010,0020));
- the patient's sex (tag (0010,0040));
- the date of birth (tag (0010,0030))

such studies are considered to be carried out for different patients. If you attempt to open them in the same tab, the following notification will pop up: **Seems that you are trying to add studies of different patients. Would you like to continue?** To add the study, click **YES**, to cancel click **NO**.

To fuse several series from different studies, proceed as follows:

1. Open the series of the first study in the PET analysis tab.
2. Go to the second tab with the list of studies and choose the second study.
3. Select the studies required by left-clicking on them while holding down the **Ctrl** key.
4. Holding down the left mouse button, drag the series to the PET analysis tab (surrounded by the red frame in Fig. 9.2). Do not release the button. The PET analysis tab is displayed above other tabs.
5. Drag the series to the window you need. If the studies may be dragged to this window, the cursor will have the shape of . If it is impossible to drag the studies to this window, the cursor will have the shape of . In this case, choose another window or change the display mode in this window (Section 9.2.1). Release the mouse button. The series (fused series) will be opened in this window.
6. If needed, repeat the actions described in points 2-5 for other series.

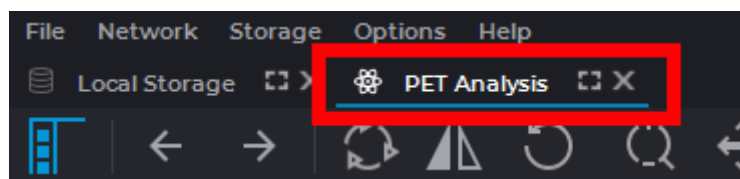

Figure 9.2: PET analysis tab stub

### 9.1.3 Viewing Images of a Series in the PET Analysis Tab

Functionality is available in a separate module which is activated in the Pro edition for an extra fee

The procedure of viewing images of a series in the PET analysis tab is similar to viewing series in the flat image viewer tab, which is described in Section 2.7.

## 9.2 PET Analysis Tab Elements

Functionality is available in a separate module which is activated in the Pro edition for an extra fee

### 9.2.1 PET Analysis tab Windows

Functionality is available in a separate module which is activated in the Pro edition for an extra fee

The PET analysis tab may contain 1-6 image viewing windows:

- One window;
- Two windows side by side;
- 2X2 grid;
- 2X3 grid.

The mode may be changed by pressing the respective button on the toolbar. The button will look different depending on the current mode:

<b>3D MIP</b>	<b>3D MIP</b> mode. The mode may be switched to Mono PET
<b>PT</b>	<b>Mono-PET</b> mode. The mode may be switched to 3D MIP
<b>CT</b>	<b>Mono-KT</b> mode
<b>PT<sub>+</sub> CT</b>	<b>Fusion PET+KT</b> mode. The mode may be switched to Mono CT





To switch the mode, activate the respective window by left-clicking on it, click the mode button and choose the mode you need from the menu. The current mode is highlighted in blue. The procedure of setting the template for each mode is described in Section 9.2.2.

On the left, you can see the **Series List** panel showing all the series for the study. To open the required series in the PET Analysis window, drag it into the window. The MIP window may only be used for PET series, but you can drag PET, CT or fused series to other windows.

Double-click any of the four windows with the left mouse button to unfold it. Please, note that you shouldn't activate any of the measuring tools, annotation tools or the magnifier with the left mouse button.

## 9.2.2 Setting the templates for windows arrangement in the PET analysis tab

Functionality is available in a separate module which is activated in the Pro edition for an extra fee

To set the windows arrangement templates, click the mode selection button (  ,  ,  or  depending on the mode) and select **Settings...** A dialog box shown in Fig. 9.3 will pop up.

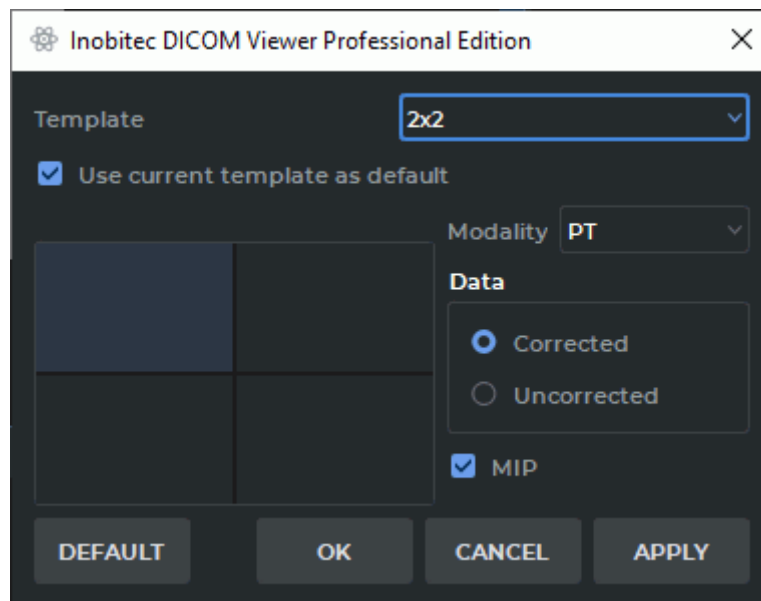

Figure 9.3: Dialog box for setting window arrangement templates

Choose a template from the drop-down menu (One, Two near, 2x2, 2x3). To use this template as default, tick the **Use current template as default** box.

To set a template window, select this window with the mouse. It will be highlighted (in Fig. 9.3 the upper left window is selected). Then proceed as follows:

1. Choose the modality from the drop-down menu (**Unspecified**, **CT**, **PT** or **PT+CT**). If the **Unspecified** modality has been chosen, the cell will be empty.
2. The DICOM Viewer allows you to open either only the corrected PET series or only those that haven't been corrected. To choose the series to be opened, check either **Corrected** or **Uncorrected** in the **Data** box. The default value is **Uncorrected**. If a series does not comply with this parameter, it will not be shown.
3. Check the **MIP** box for the PET series to display the maximum intensity projection.

To restore the default settings for the current template, click the **DEFAULT** button. In the dialog box that pops up, click **YES** to restore the settings or **NO** to cancel. By default, the following template settings are provided:

1. **One** Template: PET+CT combination is shown.
2. **Two near** Template: 3D MIP for the corrected PET series in the left window, Fusion (PET+CT) — in the right window.
3. **2x2** Template: from left to right, downwards: 3D MIP for the corrected PET series, corrected PET series, CT series, Fusion (PET+CT).
4. **2x3** Template: from left to right, downwards: 3D MIP for the corrected PET series, corrected PET series, CT series, Fusion (PET+CT), two empty windows.

Click **OK** to apply the settings or **CANCEL** to cancel the operation.

The changes in the template do not affect the tabs that had been opened before such changes were introduced.

## 9.3 MIP mode

---

Functionality is available in a separate module which is activated in the Pro edition for an extra fee

---

The DICOM Viewer allows you to change the section thickness for flat images, i.e. the image is actually shown in MIP (Maximum Intensity Projection) mode. To change the section thickness, you need to sort the images by phases and frames (the default setting for the sorting procedure; for details see Section 2.1). The changes are possible within 0-50 mm range. You cannot make the section thinner than the source image.

To change the thickness, use the tool shown in Figure 9.4, which you will find on the right-hand side of the window in **Mono-CT**, **Mono-PET** and **Fusion PET+CT** modes (see Section 9.2). In the centre you can see the current section thickness. The sliders adjusting the thickness are marked with arrows. To change the thickness, you need to move either of the sliders by pressing the left, right or middle mouse button. To make the section thicker, move the slider outwards, to make it thinner — inward.



The thickness set with the help of the tool is used when exporting and adding to the print list.

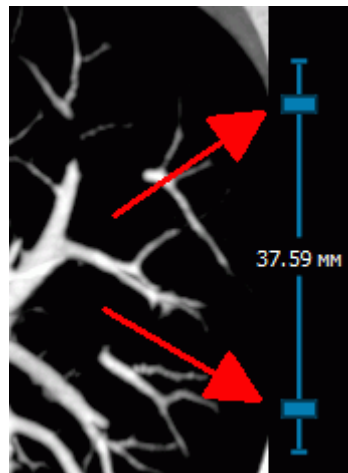

Figure 9.4: The section thickness tool for MIP

When you are working with such tools as **Point value**, **ROI rectangle**, **ROI ellipse** and **ROI polygon**, the data shown are for MIP mode images. When the thickness is changed, the value is automatically scaled. All the other measurements are performed for the source data.

## 9.4 The Play Tool

---

Functionality is available in a separate module which is activated in the Pro edition for an extra fee

---

The tool is similar to that described in Section 5.10.

## 9.5 Video recording

---

Functionality is available in a separate module which is activated in the Pro edition for an extra fee

---

The tool is similar to that described in Section 2.15.

## 9.6 PET Window settings













Functionality is available in a separate module which is activated in the Pro edition for an extra fee

For details see Section 16.7.8.

## 9.7 Image Positioning

Functionality is available in a separate module which is activated in the Pro edition for an extra fee

Use the following tools for image positioning:

	The <b>Reset views</b> tool cancels all the actions made with the <b>Rotate, Zoom, Pan</b> tools
	The <b>Rotate</b> tool is described in Section 2.16
	The <b>Zoom</b> tool is described in Section 2.16. It allows to zoom images. If the other windows displays images in the same projection, they are scaled synchronously
	The <b>Pan</b> tool is described in Section 2.16. It allows to pan images. If the other windows displays images in the same projection, they are moved synchronously
	The <b>Axial projection</b> tool displays images in the axial plane. To change the projection of the selected window to axial, click on the  button on the toolbar or press the <b>Shift+A</b> combination on the keyboard
	The <b>Coronal projection</b> tool displays images in the coronal plane. To change the projection of the selected window to coronal, click on the  button on the toolbar or press the <b>Shift+C</b> combination on the keyboard
	The <b>Sagittal projection</b> tool displays images in the sagittal plane. To change the projection of the selected window to sagittal, click on the  button on the toolbar or press the <b>Shift+S</b> combination on the keyboard
	The <b>Sync series scroll</b> tool allows you to simultaneously scroll the images in the PET, CT and PET+CT windows
	The <b>Select model point</b> tool displays in the PET, CT and PET+CT windows the images corresponding to the point selected in the MIP window

The MIP projection rotates around a vertical axis. To rotate move the cursor right and left holding the left button, or move the scroll slider.

## 9.8 Visualize Images

Functionality is available in a separate module which is activated in the Pro edition for an extra fee



**Color tables are needed for displaying pixels and voxels representing different density values in different colors for improved perception. The shades on the screen are different from the real shades.**

Image visualization is described in Section 2.22. To change the CLUT for a specific window, first select this window with a mouse click. In the PET+CT window you can change the CLUT for the PET layer only.

To change the PET layer opacity in the PET+CT window, move the slider at the top of the PET+CT window (marked with number «1» in Fig. 9.5).

The PET+CT window contains the scale of the CLUT for the PET layer (marked with number «2» in Fig. 9.5). If the SUV mode is disabled, the scale borders coincide with the minimum and maximum window values for the PET layer. If the SUV mode is enabled, then the scale borders coincide with the minimum and maximum values of the SUV in the current image of the PET layer.

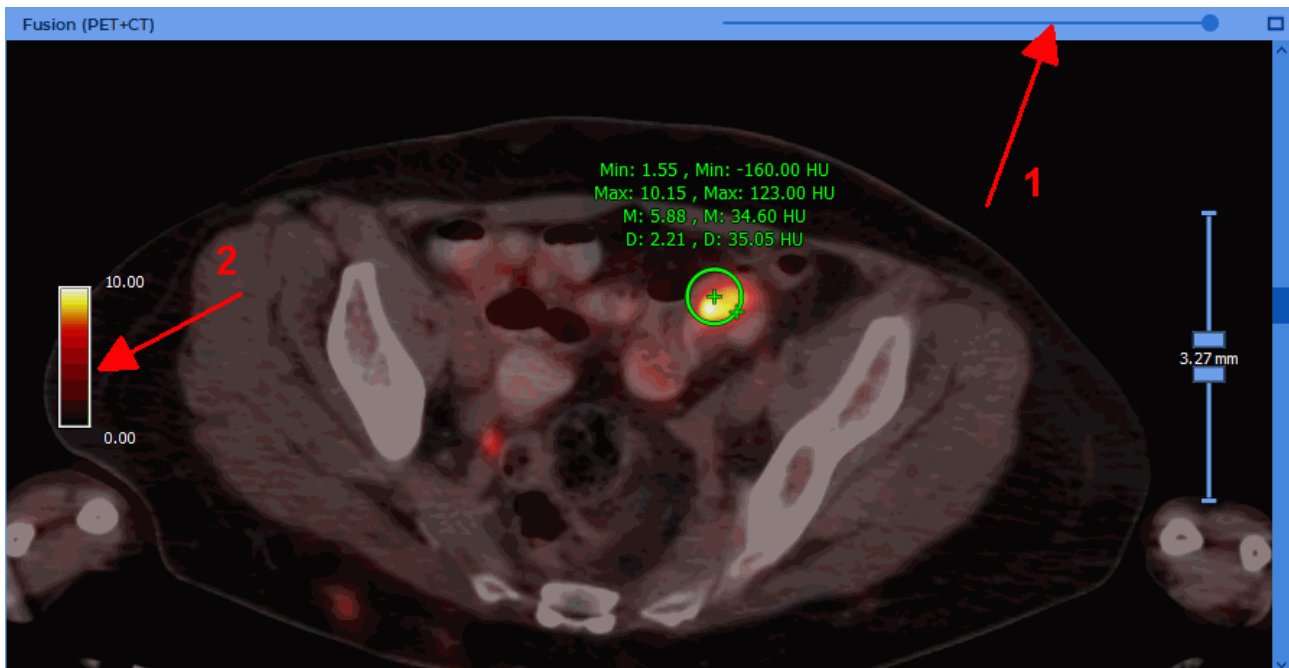



Figure 9.5: The PET+CT window

Changing the window width and the window level using the **Adjust W/L**  tool is described in 2.17. To change the window width and the window level for CT images in the CT and PET+CT windows, select the CT window with the mouse. To change the values for all PET images, select any window with the mouse, except for the CT window.



**Attention! You can change only the upper window limit in the PET+CT and PET windows for the PET layer, using the «Adjust W/L» tool.**







The default upper window level value is determined by the **Window upper limit** setting. There are two ways to adjust the upper limit:







1. **Max SUV value.** In this case, the default window upper limit is set equal to the corresponding value in the SUV mode.
2. **Max window percent.** In this case, the default window upper limit is set equal to the specified percentage of the recommended window width. Since the default lower limit for PET is zero, the window width is numerically equal to the upper limit, and the percentage is actually calculated from its value. If different recommended upper limits are set for different images of the series, then the percentage is calculated from the maximum of these values.

## 9.9 Measurements and Annotations

Functionality is available in a separate module which is activated in the Pro edition for an extra fee

Use the following tools to measure:

	The <b>Ruler</b> tool is described in Section 2.19
	The <b>Polygonal ruler</b> tool is described in Section 2.19
	The <b>Angle</b> tool is described in Section 2.19
	The <b>Point value</b> tool is described in Section 2.19
	The <b>ROI rectangle</b> tool is described in Section 2.19
	The <b>ROI ellipse</b> tool is described in Section 2.19
	The <b>ROI polygon</b> tool is described in Section 2.19

	The <b>VOI Sphere</b> tool is described in Section <a href="#">9.10</a>
	The <b>Delete all annotations and measurements</b> tool is described in Section <a href="#">2.19</a>
	The <b>Show SUV</b> tool is described in Section <a href="#">2.23</a>
	The <b>Arrow tool</b> is described in Section <a href="#">2.32</a>
	The <b>Pencil tool</b> is described in Section <a href="#">2.32</a>
<b>T</b>	The <b>Text tool</b> tool is described in Section <a href="#">2.32</a>
	The <b>Polygon</b> tool is described in Section <a href="#">2.32</a>
	The <b>Ellipse</b> tool is described in Section <a href="#">2.32</a>

To open the SUV settings dialog click the arrow on the right side of the  **Show SUV** button and select the **Settings...** item.

To display the SUV value after opening a study in the PET analysis window, set the **Enable SUV mode automatically** (see Section [16.7.8](#)). If there is not enough data to calculate SUV, then a dialog for entering parameters is displayed. For details, see Section [2.23](#).

## 9.10 Measure the Intensity Average and Standard Deviation in Space

---

Functionality is available in a separate module which is activated in the Pro edition for an extra fee

---

The **VOI Sphere** tool is similar to the ROI tools described in section [2.19](#), but the measurements are performed in the space bounded by a sphere.

### 9.10.1 Create sphere

---

Functionality is available in a separate module which is activated in the Pro edition for an extra fee

---

To create a sphere:

1. Select a series to measure, go to the image in which the center of the sphere should be located.
2. Activate the **VOI sphere** tool by clicking the  button on the toolbar. To continue work with this tool, use the button with which the tool was activated. To learn more about tool control, see Section [1.14](#).
3. The VOI sphere can be built in two ways:
  - Move the cursor to the point where the center of the sphere should be located. Click mouse button. Choose the desired sphere diameter by moving the mouse. To complete the drawing, click the mouse button.
  - Click the mouse button at the point where the center of the sphere should be located and set the desired sphere diameter while holding the mouse button. Release the mouse button to fix the sphere diameter.
4. To cancel creation, press the **Esc** button on the keyboard.

The following parameters are displayed near the sphere (Fig. [9.5](#)):

- minimum intensity value;
- maximum intensity value;
- average intensity value;
- standard deviation;

The results only for the corresponding series are displayed in the CT and PET windows, the results for both series are displayed in the PET+CT window.

### 9.10.2 Sphere location in space

---

Functionality is available in a separate module which is activated in the Pro edition for an extra fee

---

All spheres are always displayed in the MIP window. The line of the intersection of the sphere with the image plane and the measurement results are displayed in the other windows. As the distance from the center of the sphere increases, the diameter of this circle decreases.

If the sphere does not intersect with the image plane, the measurement results for the sphere are not displayed in this window.

If the center of the sphere is in the current image and the **VOI Sphere**  tool is activated, crosses are displayed in the center of the sphere and on its border.

### 9.10.3 Actions with the sphere

---

Functionality is available in a separate module which is activated in the Pro edition for an extra fee

---

To edit a sphere:

1. Go to the image that contains the center of the sphere. To do this, slide the images until the crosses appear in the center and on the border of the sphere.
2. To move the sphere, move the cursor over the cross in its center and move the mouse holding down any mouse button. When you locate the cursor over the cross it increases.
3. To change the radius, move the cursor over the cross on the sphere border and move the mouse, holding down any mouse button. When you locate the cursor over the cross it increases.

To move the block with the measurement results, locate the cursor over it and move the mouse, holding down the left mouse button or the button to which this tool is assigned. For this, it is not necessary that the center of the sphere be on the current image.

To remove a sphere move the cursor over the block with the measurement results or on the cross in the center or on the border of the sphere and press the **Delete** key on the keyboard, or right-click the mouse and select the **Remove object** command.

### 9.10.4 Drawing Parameters

---

Functionality is available in a separate module which is activated in the Pro edition for an extra fee

---

To change the drawing parameters:

1. Locate the cursor over the block with the measurement results or on the cross.
2. Right-click.
3. Select the item **Tool options...** on the context menu.
4. In the dialog box that appears, set the color by clicking on the color box.
5. Set the object name, the line thickness and the font size.

6. To connect the block with the measurement results and the sphere of the dotted line, check the **Footnote line** box.
7. To use these settings by default, check the **Set as default** box.
8. To apply the settings, click **OK**. To cancel, click **CANCEL**.

## 9.11 Synchronization in the PET analysis tab

---



Functionality is available in a separate module which is activated in the Pro edition for an extra fee

---

Synchronization will be applied if several images from the same study are opened in the **PET Analysis** tab. This function provides an opportunity to scroll images from different series simultaneously. By default, image scrolling is synchronized for the same study.

All the series are panned and zoomed simultaneously, including the series from different studies.

To enable synchronization:

1. Click on the arrow on the right side of the **Sync series scroll**  button on the toolbar.
2. Check one of the following items:
  - **Sync series (Same study)**. This option provides an opportunity to scroll images from the series with the same values of the *frameOfReferenceUid* tag simultaneously. If the values of the *frameOfReferenceUid* tag are different for different series, synchronization will not be performed;
  - **Sync from current position**. This option provides an opportunity to scroll images simultaneously from the current position.
3. If this  button is not pressed, press it.

Synchronization is performed for the sections parallel to the synchronizing section.

To disable synchronization, click on the **Sync series scroll**  button.



---

# Chapter 10

## Virtual Endoscopy

### 10.1 Open Studies in Virtual Endoscopy window

---

Functionality is available in the **Pro** edition

---

To open a study in the virtual endoscopy window:

1. Load studies to the DICOM Viewer.
2. Select the target study from the study panel.
3. Click the **Virtual endoscopy**  button on the toolbar. To select the tab location (in the current window, in a separate window or in the full screen mode), click on the arrow on the right side of the button. To open the virtual endoscopy window in a new tab in the current window, click on the button. The process may take some time.

The virtual endoscopy window is shown in Fig. 10.1.

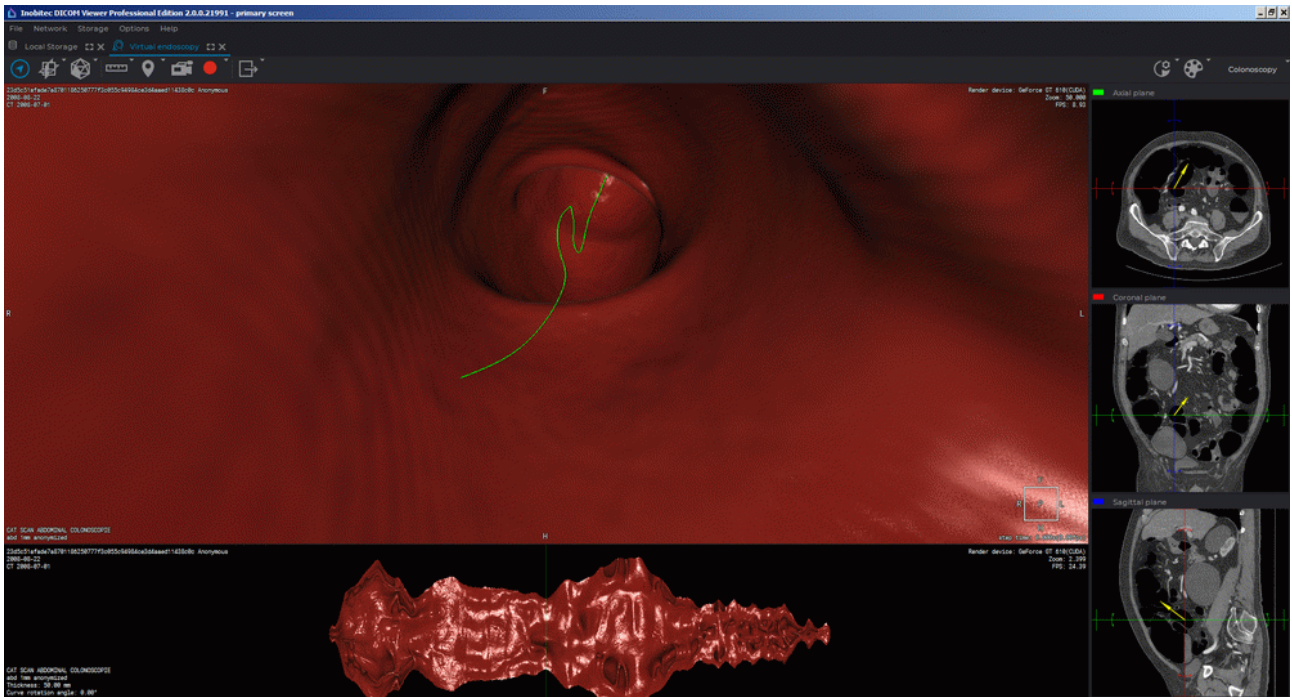

Figure 10.1: Virtual endoscopy window

If the camera is in dense body tissues, there will be no image on the left side of the screen. In this case, you need to move the camera to a body cavity manually. For details on how to move the camera, see Section 10.3.

## 10.2 View Elements. Customize MPR Panel

### 10.2.1 View Elements

---

Functionality is available in the **Pro** edition

---

The toolbar is displayed in the top left part of the tab (Fig. 10.2).



Figure 10.2: Toolbar

The MPR navigation panel is on the right side of the tab.  
 The view setup panel is in the top right part of the tab (Fig. 10.3).

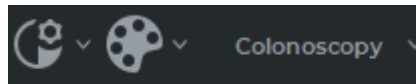

Figure 10.3: View setup panel

Once you start auto-moving (see Section 10.3.1), the cavity surface sweep will appear at the bottom of the window (Fig. 10.4).

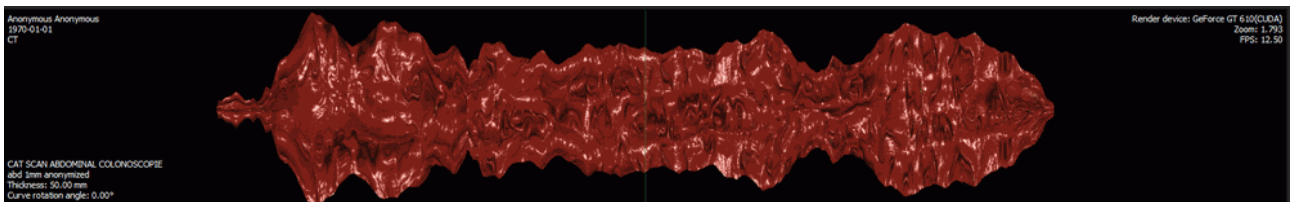

Figure 10.4: Surface Sweep panel





**Cavity surface sweep should only be used for navigation purposes. You cannot make a diagnosis on its basis. To establish a diagnosis, open the respective series in the Image Viewer window.**

## 10.2.2 Customize MPR Navigation Panel

Functionality is available in the **Pro** edition

The MPR (multiplanar reconstruction) panel consists of three parts, each displaying a body section by one of the three orthogonal planes.

To hide/display the MPR navigation panel, click the **MPR navigation**  button on the toolbar.

To change the panel size, move its border. To do this, move the cursor to the panel border so that it would look like this: , and drag the border holding the left mouse button.

To change the size of the panel parts displaying the sections by various planes, move the borders dividing the panel parts.

## 10.3 Move Camera

### 10.3.1 Move Camera Automatically

---

Functionality is available in the **Pro** edition

---



**If the camera is moved automatically, there is a danger to overlook important areas. Use this option only in combination with manual control.**

To move the camera automatically:

1. Drag the camera to a body cavity, using the MPR navigation panel. If the left side of the screen displays the red cavity surface, it means that the camera is in the cavity. If not, the camera is located in dense tissues. In this case, correct its position.
2. Start auto-moving by clicking the **Space** key or the **Fly-through camera**  button on the toolbar.

The camera can be stopped in a similar way.

After you activate automatic movement, the central line appears. The camera moves along the central line. The color of this line is green. The vertical line on the sweep panel corresponds to the camera position.



**If the image quality is poor, the central line may be drawn incorrectly. You need to make sure that it is drawn correctly.**

To increase the movement speed, press + on the keyboard, to decrease the speed, press -.



### 10.3.2 Manage Camera Manually

---

Functionality is available in the **Pro** edition

---

You can manage the camera manually, using the cursor management keys. Key functions:

	move the camera forward
	move the camera back
	rotate the camera anticlockwise

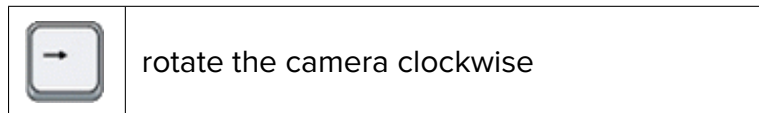

To manage the camera, using the mouse and the keyboard:

1. To change the camera rotation angle, move the mouse, holding the wheel. The camera turns in the same direction as the cursor. The camera direction vector will be displayed on the MPR navigation panel.
2. To move the camera over the image plane, move the mouse, holding the wheel and the **Shift** key. The camera turns in the same direction as the cursor.
3. To move the camera at random, use the MPR navigation panel. Click the left mouse button at the target place in any projection window or move the mouse, holding the left button. The camera will move in the same direction as the cursor.
4. To move the camera along the central line, move the surface sweep, holding the left button. The vertical line on the sweep panel corresponds to the camera position.
5. To point the camera at the point on the surface, click the right mouse button on this point on the sweep panel.

## 10.4 Video recording

---

Functionality is available in the **Pro** edition

---

The DICOM Viewer allows you to record video for the surface view window. The following objects will be recorded:

- tissues;
- the center line.
- measurements;
- markers;
- tags;
- orientation cube;

The other features of the tool in the MPR View windows are similar to those described in Section 2.15.

## 10.5 Customize Image

---

Functionality is available in the **Pro** edition

---



To increase or decrease the camera angle, turn the mouse wheel backward or forward respectively. To change the view configuration, use the visualization setup panel in the top right part of the tab. For details on how to work with the panel, see Section 5.5.

## 10.6 Measurements and Markers

---

Functionality is available in the **Pro** edition

---

The DICOM Viewer allows you to place markers on an image and conduct linear measurements. For details on working with the **Marker** tool, see Section 3.12. The use of the **Ruler** and **Polygonal ruler** tools is described in Section 2.19 and Section 3.11.2. However, in the virtual endoscopy window you should switch between the **Polygonal ruler** and **Ruler** tools, using the menu that opens by clicking on the arrow on the right side of the  button (or  in the polygonal ruler mode).

## 10.7 Multiplanar Reconstruction

---

Functionality is available in the **Pro** edition

---

To switch to multiplanar reconstruction, click the **MPR reconstruction**  button. Reconstruction will open in a new tab. Multiplanar reconstruction is described in Chapter 5.

The camera position is synchronized with the cursor position in MPR, and navigation is performed synchronously. For convenience, you can open MPR in a separate window and position it next to the virtual endoscopy window.

## 10.8 Surface Reconstruction

### 10.8.1 Create Surface

---

Functionality is available in the **Pro** edition

---

For reconstruction, click the **Surface reconstruction**  button on the toolbar.

The process may take some time.

A sample reconstruction is shown in Fig. 10.5.

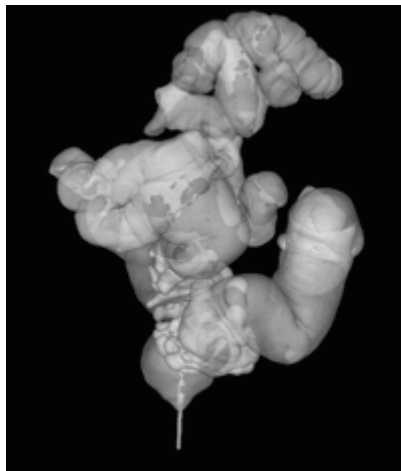
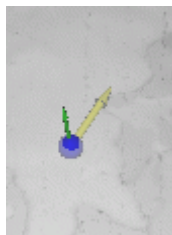

*Figure 10.5: Surface reconstruction*

To display/hide the camera orientation in the surface window, click the **Show camera orientation**  button. The camera orientation on the surface is synchronized with the virtual endoscopy tab. For convenience, you can open surface reconstruction in a separate window and position it next to the virtual endoscopy window.

The camera position is highlighted by the blue marker.

The yellow vector shows the view direction, and the green one points upward from the camera (Fig. 10.6).



*Figure 10.6: Camera orientation view elements*

## 10.8.2 Surface Orientation and Navigation

---

Functionality is available in the **Pro** edition

---

- To rotate the surface, move the mouse, holding the wheel. To select one of the predefined orientations, use the buttons on the orientation panel. (Fig. 10.7).



*Figure 10.7: Surface orientation panel*

- To move the camera, activate the camera orientation view and click the left mouse button on the 3D surface reconstruction. The camera will move to the selected place in the center of the cavity. If there are overlapping body cavities, the camera will be located in the cavity nearest to the user.
- To change the camera vector, right-click the mouse at any point on the surface. The vector will be directed to this point.
- To change the model transparency, move the **Model transparency** scroll.
- To drag the surface, move the mouse, holding the wheel and the **Shift** key.
- To zoom the surface, move the mouse, holding the wheel and the **Ctrl** key.



## 10.9 Export

---

Functionality is available in the **Pro** edition

---

The export of images is similar to the image export described in Section [2.27](#), but you cannot export an entire series.

# Chapter 11

## ECG Viewer



The diagnosis can only be established for body-surface ECG.

### 11.1 Select Data Source

Select the data source. The source selection algorithm is described in Section 1.5.

### 11.2 Open Series in ECG View window

Load studies to the DICOM Viewer and select the target study. There are five ways to open a series:

1. Click the **ECG Viewer**  button on the toolbar. To select the tab location (in the current window, in a separate window or in the full screen mode), click on the arrow on the right side of the button. To open an ECG in a new tab in the current window, click on the button.
2. Double-click the left mouse button on the study title on the study bar.
3. Double-click the left mouse button on the series icon on the series panel.
4. Drag the series icon to the study panel, holding the left mouse button.
5. Right-click the mouse to call the context menu for the series icon and select one of the items in the **ECG Viewer** section. The ECG will open in a new tab in the current window (Fig. 11.1).

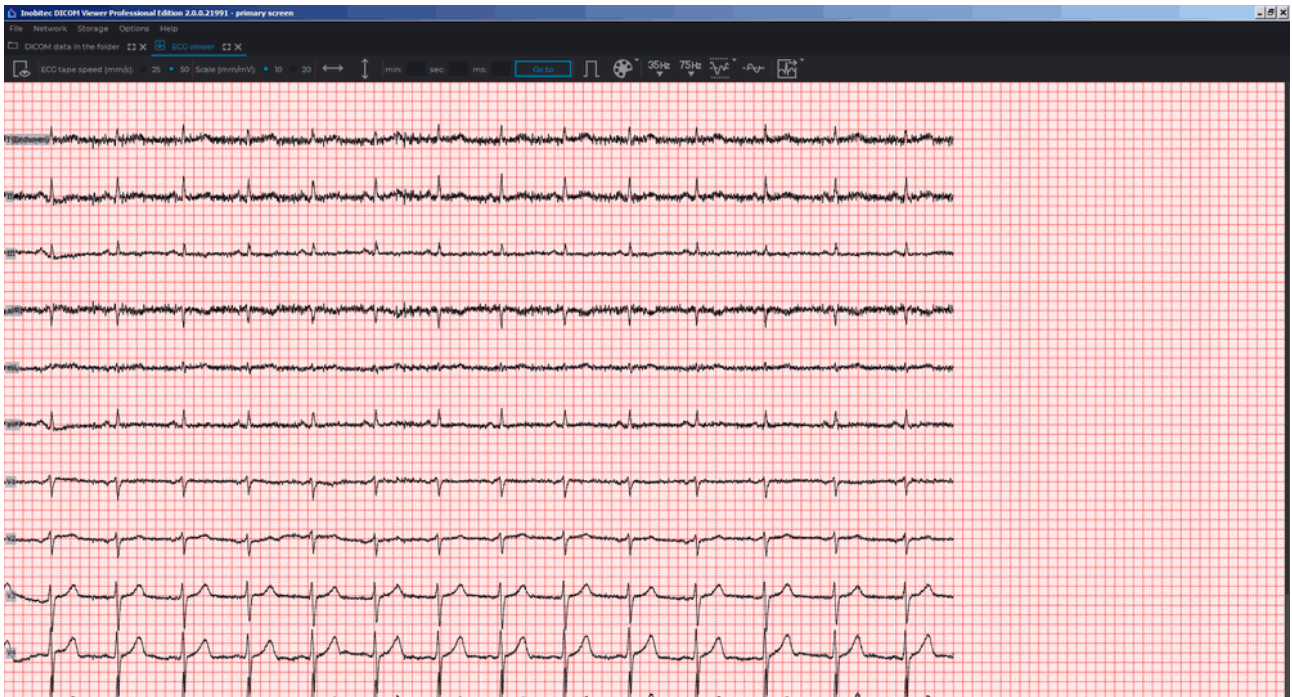

Figure 11.1: ECG view window

## 11.3 View Graphs

If the graphs do not fit on the screen, then:

- pan them horizontally with the mouse, holding the left button;
- pan them vertically by rolling the mouse wheel.

If a series contains several pages, the View pages panel appears in the upper right-hand part of the window (fig. 11.2).



Figure 11.2: View pages panel

To view the pages move the cursor over the scroll bar and rotate the mouse wheel or click the  $\leftarrow$   $\rightarrow$  buttons. The panel displays the current page number and the total number of pages.

## 11.4 Toolbar

The toolbar is at the top of the tab (Fig. 11.3).

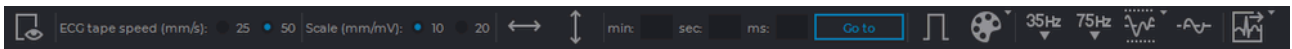

Figure 11.3: Toolbar

### 11.4.1 Select Lead

To select the ECG leads to be displayed:

1. Click the **Set visible leads**  button on the toolbar. The window shown in Fig. 11.4 will be displayed.
2. Check the leads to be displayed. By default, all the leads are displayed.
3. Click **OK** to apply the settings or **CANCEL** to cancel the actions.



Figure 11.4: Lead selection window

### 11.4.2 ECG Speed

Two speed values are available: 25 and 50 millimeters per second. The default speed is 50 millimeters per second. The required value is set using a switch (Fig. 11.5).

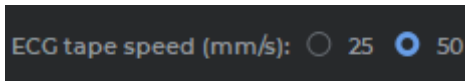

Figure 11.5: Toolbar (speed setup)

### 11.4.3 Scale

Two scale values are available: 10 and 20 millimeters per millivolt. The default scale is 10 millimeters per millivolt. The required value is set using a switch (Fig. 11.6).

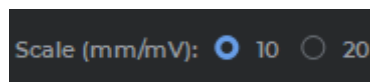

Figure 11.6: Toolbar (setting the scale)

### 11.4.4 Length Interval

To select a length interval:

1. Activate the **Interval**  $\longleftrightarrow$  tool on the toolbar.
2. Move the mouse along the graph to find the point to start with (it does not matter if the point is located on the left or on the right).
3. Click any mouse button to fix the point.
4. Move the mouse along the graph to locate the second point. The interval length value will be displayed against the interval background.
5. Click any mouse button to fix the point.

To move the interval, locate the cursor on it and drag it holding down the left mouse button or the button to which this tool is assigned.

Only one interval can be built at a time.

To delete the interval, deactivate the **Interval** tool.

### 11.4.5 Value Interval

To select a value interval:

1. Activate the **Values Interval**  $\updownarrow$  tool on the toolbar.
2. Move the mouse over the graph to locate the point to start with (it does not matter if the point is located at the top or at the bottom).
3. Click any mouse button to fix the point.

4. Move the mouse over the graph to locate the second point. The value matching the interval will be displayed against the interval background.
5. Click any mouse button to fix the point.



**The units of measure of a value interval for an ECG series are determined automatically on the basis of the DICOM tags for the series. If the required data are missing, the value of the selected interval is not displayed.**

To move the interval, locate the cursor on it and drag it, holding down the left mouse button or the button to which this tool is assigned.

Only one interval can be built at a time.

To delete the interval, deactivate the **Values Interval** tool.

### 11.4.6 Move to a Time Point on the Graph

To move to a particular time point on the graph, enter the values (minutes, seconds and milliseconds) into the corresponding areas on the toolbar (Fig. 11.7) and click the **GO TO** button. The graph will move to display its part starting from the specified time. You can drag the graph with the mouse at any time.

If the entered time value exceeds the study duration, the graph will be out of vision. Enter a new value or move the graph manually.

If some parameter has a zero value, it does not need to be entered. For instance, to move to the time point 1 minute 110 milliseconds, enter the values as shown in Fig. 11.7.

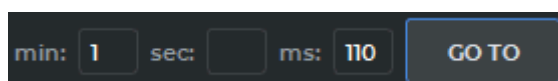



Figure 11.7: Go to the time point 1 minute 0 seconds 110 milliseconds

### 11.4.7 Set Up Coordinate Plane

To display the scale on the coordinate plane, activate the **Scale ECG**  tool on the toolbar (by default it is inactive). To hide the scale line, click the button again.



**The ECG scale is determined automatically on the basis of the DICOM tags for the series. If the required data are missing, the scale line is not displayed.**

To change the color scheme, click the **Choose color scheme**  button on the toolbar. Two color scheme options are available: classic (set by default) and green (Fig. 11.8).



Figure 11.8: Green color scheme

## 11.5 Frequency Filters

Functionality is available in the **Pro** edition

If an ECG is recorded with distortions, use filters to correct the graphs.



**When filters are used, graphs are changed. To establish a diagnosis, you need to use original data.**

These filters remove the components whose frequency is higher than 35 Hz (the **35Hz Low pass filter 35 Hz** button) or 75 Hz (the **75Hz Low pass filter 75 Hz** button). To apply the filter, click the corresponding button. To cancel filtering, click the corresponding button again. Only one filter can be applied at a time.

To remove power line interference from the ECG signal, use the Notch filter. The tool has 2 predefined values (50 Hz and 60 Hz). To select a filter value, click on the arrow on the right side of the **Notch filter** button. The current value is marked with a flag. If you need to set a different value, select the **Custom...** item in the button menu and set the value in the dialog that opens. To use the filter with the current value, click on the **Notch filter** button. To cancel filtering, click the button again.

To remove the walks of the baseline of the graph, use a High pass filter 1Hz. To apply the filter, click the **High pass filter 1Hz** button. To cancel filtering, click the button again.

## 11.6 Export series

---

Functionality is available in the **Pro** edition

---

When exporting, a series is saved in the filtered form. The series is stored in the local storage in the same study. To open the export dialog, click on the arrow on the right side of the  **Quick export ECG** button.

If necessary, change the description of the series.

To upload the series to the default PACS server when exporting, check the **Upload ECG to the default server** box in the export dialog.

To export the series with the default settings, click the  **Quick Export ECG** button.



---

# Chapter 12

## Image annotation

---

Functionality is available in a separate module which is activated in the Pro edition for an extra fee

---

The module described in this chapter is aimed for marking various objects on DICOM images manually with the help of contours and exporting them in JSON format. The results of image annotation may be used for training neural networks created for recognition of image components.

The following terms will be used in the description of the image annotation module:

**Object** — A selected part of an image.

**Annotation** — Marking objects.

**Class (of objects)** — Objects united by a quality specified by the user. A class is characterized by a unique name and properties.

The image annotation module is available in the flat image viewer tab and provides for the following functions:

- create / edit a list of object classes and unite classes in groups;
- select objects belonging to different classes with contours;
- export and import the tree of object classes and groups;
- save image annotation results and open them to continue work;
- export annotation results with DICOM data.

## 12.1 Licensing the Image Annotation Module

Functionality is available in a separate module which is activated in the Pro edition for an extra fee

The image annotation module provides for dual-level access to the function. The users with extended rights have an additional opportunity to create and edit classes and groups. The other users may use the standard functions of the module, while the functions of creating, editing and exporting the tree of object classes and groups is not available for them.

When a user launches the module and attempts to open the image annotation results, the annotation panel with the standard functions of the module appears on the screen. If the user does not have an active license for the image annotation module, a dialog box (see Fig. 12.1) pops up suggesting that a free trial period should be activated.

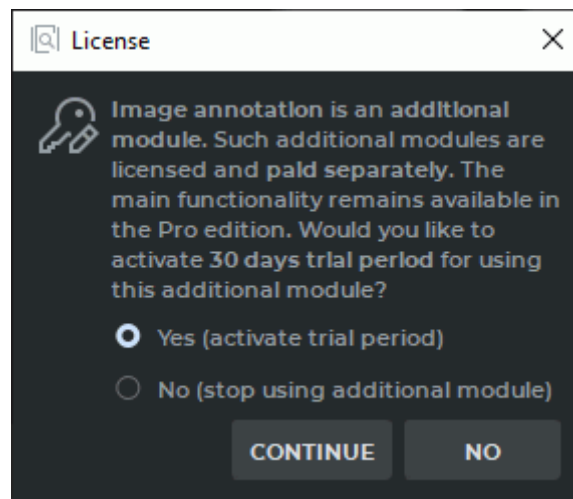

Figure 12.1: The dialog box for the trial period activation

Additional functions of the image annotation module are available upon the user's request. No free trial period will be available in this case. If the license or the free trial period has expired, the annotation panel will not be opened. A dialog box notifying the user that a license must be purchased will pop up instead.

## 12.2 Opening a Series in the Image Annotation Mode

Functionality is available in a separate module which is activated in the Pro edition for an extra fee

To open a series in the image annotation mode, proceed as follows:

1. Open the series in the flat image viewer tab.
2. Choose **Image annotation** on the main **Image** menu.

The image annotation panel will be opened on the right-hand side of the window (see Fig. 12.2). This panel contains function buttons (in the red box) and the tree of groups and classes (in the green box).

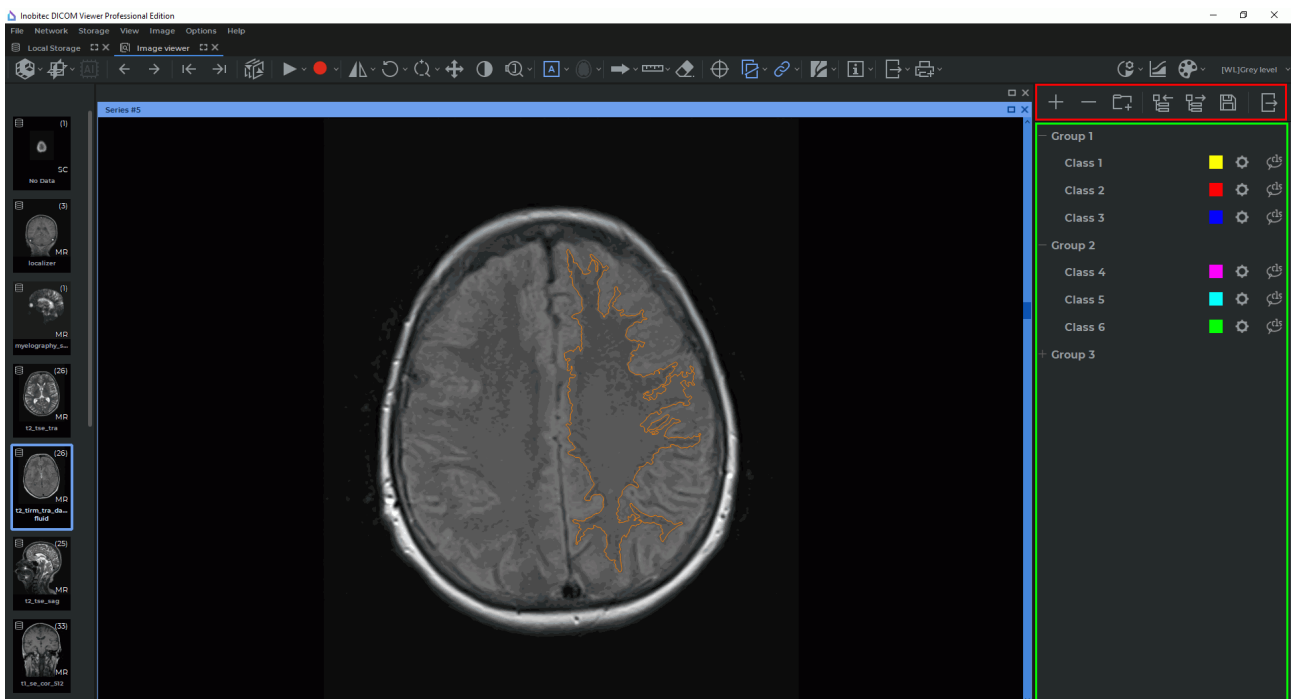







Figure 12.2: The flat image viewer tab in the image annotation mode

The function buttons on the image annotation panel:

+	The <b>Add class</b> button is available when no elements or just one element has been selected on the tree of groups and classes. If a group is selected, the new class will be added to this group. If a class is selected, the new class will be added to the group where the selected class belongs. If the selected class does not belong to any group, the new class will be added to the superior level. The button is only available for users who have extended rights.
-	The <b>Remove group/class</b> button deletes the selected groups and classes. The button is only available for users with extended rights.
	The <b>Add group</b> button creates a new empty group if there are no classes among the selected list items. If one or more classes have been selected in the list, the selected classes are combined into a new group.
	The <b>Import the tree of groups and classes</b> button opens a dialog box for selection of a JSON file in order to import a tree of groups and classes.
	The <b>Export the tree of groups and classes</b> button opens a dialog box for selection of a JSON file in order to save the results. When the user presses the <b>Save</b> button, a new JSON file is created or the existing JSON file with the data on the current tree of groups and classes is overwritten. The button is only available for users with extended rights.
	The <b>Save results</b> button allows for saving the current annotation results in order to resume work with them after the program is relaunched. When the user presses the button, a dialog box pops up for saving the data on all the objects that have been marked for all the study series in the current tab. DICOM data are not saved.
	The <b>Export results with DICOM</b> button exports the image annotation results together with the DICOM data. The data are exported into a separate folder or archive.

## 12.3 Creating a Tree of Object Groups and Classes

---

Functionality is available in a separate module which is activated in the Pro edition for an extra fee

---

A tree of groups and classes is a hierarchical list of items. The items of the superior level are object groups and/or classes. The classes of objects that do not belong to any group are shown at the top of the list.

### 12.3.1 Creating a New Class of Objects

Functionality is available in a separate module which is activated in the Pro edition for an extra fee



**Attention! This function is only available for users with extended rights.**

There are two ways to add a new object class:

- click the **Add class**  button on the image annotation panel;
- through the context menu: right-click on the annotation panel and select the **Add class...** option.

In the **New class** dialog box (Fig. 12.3)), print the name of the object class. By default, an object class is assigned a name in *Class <unique number>* format.

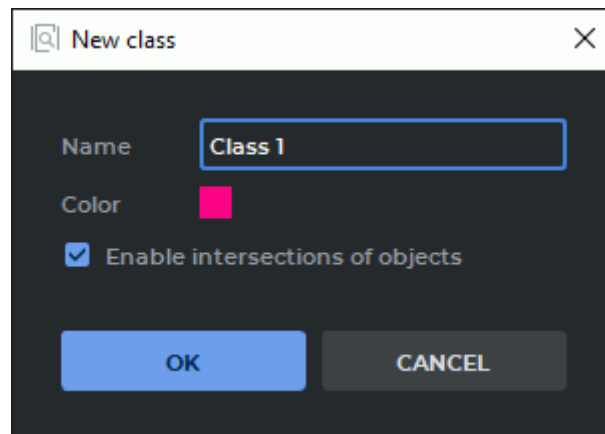

Figure 12.3: The dialog box for adding a new object class

In order to avoid intersection of object contours, uncheck the **Enable intersections of objects** box. The box is checked by default. Customize the color of the contours for this class of object by pressing the color icon and selecting a suitable color in the respective dialog box.

Click **OK** to create a new object class or **CANCEL** to cancel.

If a group is selected when the user presses the **Add class** button, the new object class will be added to the selected group. If a class is selected, the new object class will be added to the group to which the selected class belongs. If the selected class does not belong to any group, the new object class will be added to the superior level of the tree.

## 12.3.2 Creating a Group of Object Classes

Functionality is available in a separate module which is activated in the Pro edition for an extra fee



**Attention! This function is only available for users with extended rights.**

There are two ways to add a new group:

- click the **Add group**  button on the image annotation panel;
- through the context menu: right-click on the annotation panel and select the **Add group...** option.

In the **New group** dialog box (Fig. 12.4), print the name of the group. By default, a group is assigned a name in *Group <unique number>* format.

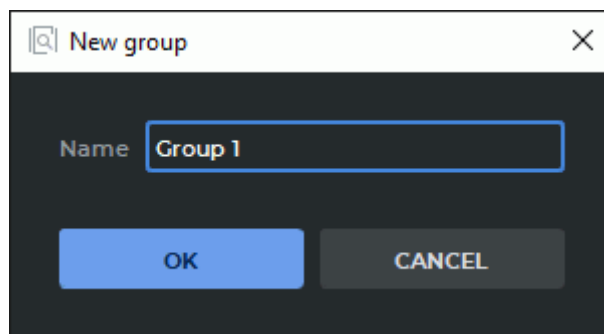

Figure 12.4: A dialog box for adding a new group

Click **OK** to create a new group or **CANCEL** to cancel.

If one or several classes are selected on the list when the user presses the **Add group** button, these classes are automatically transferred to the new group. Otherwise, a new empty group will be added.

## 12.3.3 Operations with Object Classes and Groups

Functionality is available in a separate module which is activated in the Pro edition for an extra fee





**Attention! This function is only available for users with extended rights.**



**If the current tree of object classes and groups is changed, it may result in incompatibility with the trees that were created earlier (see Section 12.3.4).**

The following actions may be performed with groups and classes:

- **moving.** To change the structure of a tree of groups and classes, mouse over a group or class and drag the selected group or class to another place on the tree while holding the left mouse button;
- **renaming.** Double-click on the name of a group or class, type the new name and press **Enter** on the keyboard;
- **editing class parameters.** Click the **Settings**  button for the selected object class and change the parameters in the **Class settings** dialog box. The interface of the **Class settings** dialog box is identical with the interface of the dialog box for creating a new class (see Fig. 12.3);
- **deleting.** Select a group or class. Click the right mouse button and select the **Remove group/class** option from the context menu or click the **Remove group/class**  button on the image annotation panel.

When the user terminates work with the program, the current state of the tree of groups and classes is saved in a JSON file if it contains at least one group and/or class. Otherwise, the JSON file will be deleted. The file named *ia\_classes.json* is placed in the *<Path to the storage>/ImageAnnotation* directory where the *<Path to the storage>* is the path specified in the **Workspace** section of the general settings window (see Section 16.1).

When the program is launched, the current tree of groups and classes is automatically opened from the Specified JSON file. If such a file does not exist, an empty image annotation panel will pop up when the program is launched.

#### 12.3.4 Compatibility of Trees of Groups and Classes

---

Functionality is available in a separate module which is activated in the Pro edition for an extra fee

---

Each tree of groups and classes is assigned a unique identifier (uid) and a number of the version which is changed when the structure of the tree is altered.

If the user, after importing/exporting the classes and groups tree, saving results or exporting results with DICOM data, performs one of the following actions with the tree of groups and classes:

- adds a new class;
- changes the parent group for the class (by dragging);
- adds a new group;
- deletes a group;
- changes the name of a group,

then the version of the tree of groups and classes will be changed (increased by 1). The unique identifier (uid) of the tree will stay the same.

If the user, after importing/exporting the classes and groups tree, saving results or exporting results with DICOM data, performs one of the following actions with the tree of groups and classes:

- deletes a class;
- changes the name of a class;
- changes the color of objects for a class;
- changes the intersection option for objects belonging to a certain class,

then a new uid will be generated for the tree of groups and classes, and the tree version will be reset to 1.

Trees with the same uid are compatible and may be upgraded (see Section 12.4.2). Trees with different uids are incompatible, but one tree may be replaced by another (see Section 12.6.2).

The uid value and the tree version number are saved in a JSON file when the tree is exported, or when the annotation results are exported or saved.

## 12.4 Export and Import of the Tree of Groups and Classes

---

Functionality is available in a separate module which is activated in the Pro edition for an extra fee

---

The export and import option provides an opportunity to save and transfer a tree of groups and classes as a JSON file from one computer to another. A tree of groups and classes created by a user with extended rights may be shared by common users.

### 12.4.1 Export of the Tree of Groups and Classes

---

Functionality is available in a separate module which is activated in the Pro edition for an extra fee

---



**Attention! This function is only available for users with extended rights.**

The function of exporting the current state of the tree of groups and classes provides an opportunity to save the data on the tree of groups and classes specified on the image annotation panel in a JSON file.

To export the current state of the tree of groups and classes, click the **Export the tree of groups and classes**  button on the image annotation panel. In the dialog box that pops



up, choose a place where you want to save the file with the data and enter the name of the file. Click **Save** to save the file or **Cancel** to cancel.

In case of an error, a respective dialog box will pop up.

## 12.4.2 Import of a Tree of Groups and Classes

Functionality is available in a separate module which is activated in the Pro edition for an extra fee

The function of importing a tree of groups and classes provides an opportunity to open a tree of groups and classes from a JSON file on the image annotation panel.

To import a tree of groups and classes, click the **Import the tree of groups and classes**  button on the image annotation panel. In the dialog box that pops up, choose an exported JSON file with data on groups and classes.

To upgrade a tree of groups and classes, import a superior version of the tree.



**The imported JSON file with data on the tree of groups and classes from the image annotation panel must be created by exporting the tree of groups and classes (see Section 12.4.1).**

Click **Open** to import the tree of groups and classes or **Cancel** to cancel.

## 12.5 Marking Objects with Contours

Functionality is available in a separate module which is activated in the Pro edition for an extra fee

You can use contours to mark objects in DICOM images. Contours are drawn separately for each image (slice, phase, or frame) with the **ROI object (contour)** tool in the **Image viewer** tab in the image annotation mode.

To mark an object with a contour, proceed as follows:

1. Open a series in the **Image viewer** tab. Enable the image annotation mode (see Section 12.2).
2. If there is no tree of groups and classes on the image annotation panel, it must be imported or created.
3. In the line for the respective class on the image annotation panel, activate the **ROI object (contour)**  tool with the left, right, or middle mouse button. Use the same button to work with the tool. For details on the use of tools, see Section 1.14.
4. Build a contour in one of the following ways:
  - **building contours manually.** Build a contour around the chosen area while holding the mouse button with which the tool was activated. To finish the procedure,

release the mouse button. To cancel the contour that has not been closed, press **Esc** on the keyboard while holding the button;

- **building contours with an isoline.** Move the cursor around the selected area while holding the **Shift** button on the keyboard. Under the cursor, you will see an isoline characterized by even points density. You can only see an isoline on the surfaces where a contour can be built. To build a contour with an isoline, click the left mouse button or the mouse button with which the tool was activated.

The color of the contour is the same as the color selected for the class of objects.



**Contours can only be built for the orthogonal projection that was received from the modality.**

Contours may intersect if the **Enable intersections of objects** box in the object class parameters is checked for at least one of them. This box is checked by default.

To disable intersection of contours, uncheck the **Enable intersections of objects** box in the object class parameters. If intersection of contours is disabled, corrections will be made after a contour is built or edited: the shared areas will be deleted.

When a contour is built or edited, intersection of the current contour with those that have already been built may be prohibited. To prohibit intersection for the current contour, press and hold the **Ctrl** key on the keyboard when finishing the building or editing procedure. The shared areas will be deleted.

If one of the contours is inscribed in the other, they are not considered intersecting.

### 12.5.1 Actions with Object Contours

---

Functionality is available in a separate module which is activated in the Pro edition for an extra fee

---

The DICOM Viewer provides for the following actions with object contours:

- **editing.** To edit a contour, place the cursor over it. When you hover over the contour line, it is highlighted. Place the cursor over the area that needs editing and click the mouse button. Draw a new contour while holding the button. To finish the editing procedure, release the mouse button;
- **deleting.** Place the cursor over the contour line, press the **Delete** key on the keyboard or click the right mouse button and choose the **Remove object** option from the right-click menu;
- **deleting all the Contours.** To delete all the contours of the objects for the current series, choose the **Remove all objects** option from the right-click menu. In the dialog box that pops up, click **YES** to delete or **NO** to cancel.

## 12.5.2 Changing the Class of Object Contour

Functionality is available in a separate module which is activated in the Pro edition for an extra fee



If the current tree of object classes and groups is changed, it may result in incompatibility with the trees that were created earlier (see Section 12.3.4).

To change the class of the object contour, proceed as follows:

1. Place the cursor over the contour. When you hover over the contour line, it is highlighted.
2. Click the right mouse button and select the **Classes** option from the right-click menu (Fig. 12.5). The group and the class of the selected object contour are ticked on the dropdown list.
3. Change the class of the object contour by selecting a suitable option from the list.

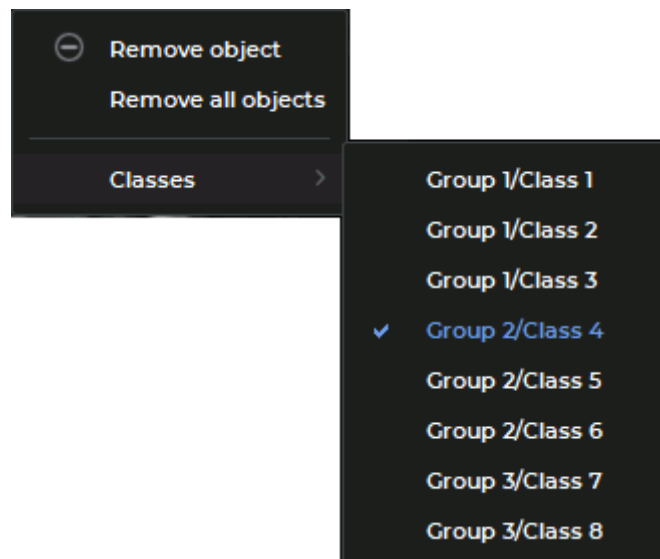

Figure 12.5: Right-click menu for object contours

The characteristics of the selected class are applied to the contour.

## 12.6 Saving and Opening Annotation Results

---

Functionality is available in a separate module which is activated in the Pro edition for an extra fee

---

The DICOM Viewer provides for an opportunity to save the annotation results in a JSON file, as well as to open files with annotation results in order to resume work. When a file is opened, the data contained in it are added to the data that already exist.

### 12.6.1 Saving Annotation Results

---

Functionality is available in a separate module which is activated in the Pro edition for an extra fee

---

To save the image annotation results, click the **Save results**  button on the image annotation panel. In the dialog box that pops up, choose the directory where the file with the annotation results is to be saved and print the name of the file. Click **Save** to save the file or **Cancel** to cancel.

The results are saved in a JSON file containing the following information:

- data on groups and classes;
- data on images (study ID, series ID, image ID);
- data on objects of the contours.

The saved file contains information on all the objects annotated for all the study series in the current tab (for all series from the series panel of the current tab). The file is saved without DICOM data.

### 12.6.2 Opening Annotation Results

---

Functionality is available in a separate module which is activated in the Pro edition for an extra fee

---

To open the image annotation results that were saved earlier, select the **Open image annotation results...** option on the **File** menu. In the dialog box that pops up, select a saved JSON file with annotation results.

The following conditions must be met in order to open the annotation results successfully:

- the uid of the tree of groups and classes in the JSON file must be the same as the uid of the tree of groups and classes opened in the program;

- the version of the tree of groups and classes in the JSON file must be inferior to or the same as the version of the tree of groups and classes opened in the program;
- in the local DICOM Viewer storage, there must be at least one series specified in the JSON file.

If at least one of these conditions is not met, a dialog box notifying of the error will pop up and the annotation results will not be opened.

If the version of the tree of groups and classes in the JSON file is superior to the version of the tree opened in the program, a respective tree replacement notification will pop up when the user attempts to open the annotation results.

If some of the series specified in the JSON file are missing from the local storage, a respective notification will pop up when the user attempts to open the annotation results.

## 12.7 Export of Annotation Results

Functionality is available in a separate module which is activated in the Pro edition for an extra fee

The DICOM Viewer provides an opportunity to export image annotation results with DICOM data. The data are exported in a separate folder or archive.

Exported data includes:

- a JSON file named *ia\_results.json* that contains data about the tree of groups and classes and about the marked outline objects;
- *DICOM* folder with dcm files of the series, on the images of which the objects were marked and the DICOMDIR file.

To export annotation results:

1. Click the **Export results with DICOM**  button on the image annotation panel.
2. In the **Export image annotation results with DICOM** dialog box (Fig. 12.6), enter the name of the destination folder in the **Folder name** field.

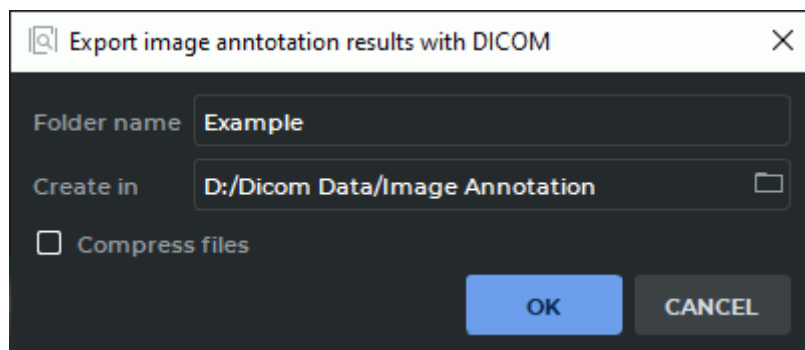

Figure 12.6: A dialog box for export of image annotation results with DICOM

3. Specify the path to the destination folder in the **Create in** field or click on the folder button to select a folder in the folder selection dialog box. If the path specified does not exist, an error notification will pop up when the **OK** button is clicked.
4. To compress the exported data, check the **Compress files** box. The name of the **Folder name** field will be changed to **File name**. The data will be exported to a ZIP file, the name of which will be specified in the **File name** field. By default, the **Compress files** box is not checked.

Click **OK** to export the annotation results or **CANCEL** to cancel.

---

# Chapter 13

## Network



To avoid personal data disclosure, secure channels should be used for data transfer via the network.

### 13.1 Services

#### 13.1.1 DICOM Service (PACS Server functionality)

The DICOM Viewer can take on the role of a PACS server. The data in the Local Storage will be available for clients. To do this, enable and set up the DICOM Service and add clients to the PACS Servers list (section 13.2).

Select the **Services...** item from the **Network** menu. In the drop-down menu, choose the **DICOM Listener...** option. The dialog box shown in Fig. 13.1 will pop up.

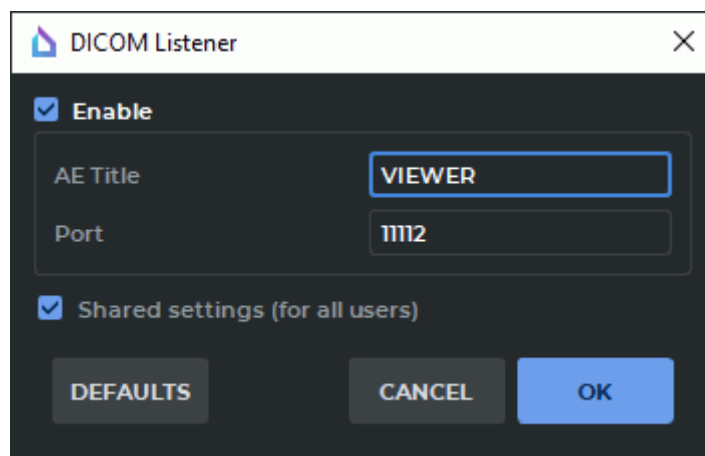

Figure 13.1: Service DICOM Listener

To set up the DICOM Listener Service:

1. Check the **Enable** box.

2. In the **AE Title** field, enter a user-defined title for the computer that the is installed on to identify it on the server. The length of AE Title value shall not exceed 16 characters. Cyrillic letters and «\» symbols in AE titles are not allowed.
3. In the **Port** field, specify any free port of the computer the DICOM Viewer is installed on. If you are not sure which value to specify, use the default value. This information can be obtained from your system administrator.
4. To restore the service default settings, click **DEFAULTS**.
5. To save the current settings for all the users of this PC, check the **Shared settings (for all users)** box. It can only be done if the DICOM Viewer was launched by a user with administrator privileges. The users who do not have administrator privileges cannot check or uncheck this box. In such a case an error message will pop up.
6. Click **OK** to apply the settings or **CANCEL** to cancel. If the port is busy, the message **Dicom Listener cannot be run. Error message: The address is protected** will pop up. In this case, select another port and repeat the previous action.

### 13.1.2 HIS/HTTP Service

This service is used to manage the DICOM Viewer using the http protocol. Select the **Ser- vices...** item from the **Network** menu. In the drop-down menu, choose the **HIS/HTTP Ser- vice...** option. The dialog box shown in Fig. 13.2 will pop up.

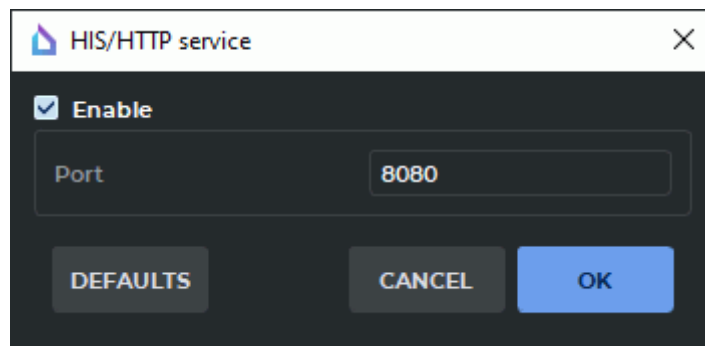

Figure 13.2: HIS/HTTP Service dialog box

To set up the HIS/HTTP Service:

1. Check the **Enable** box.
2. In the **Port** field under the **Enable** checkbox, specify any free port of the computer the DICOM Viewer is installed on. If you are not sure which value to specify, use the default value. The default port number is 8080. This information can be obtained from your system administrator.
3. To restore the default settings, click **DEFAULTS**. By default, the **Enable** box is unchecked, and port 8080 is used.
4. Click **OK** to apply the settings or **CANCEL** to cancel. If the port is busy, the message will pop up. In this case, select another port and repeat the previous action.



### 13.1.3 Web Access

Functionality is available in the **Pro** edition

Select the **Services...** item from the **Network** menu. In the drop-down menu, choose the **Web Service...** option. The dialog box shown in Fig. 13.3 will pop up.

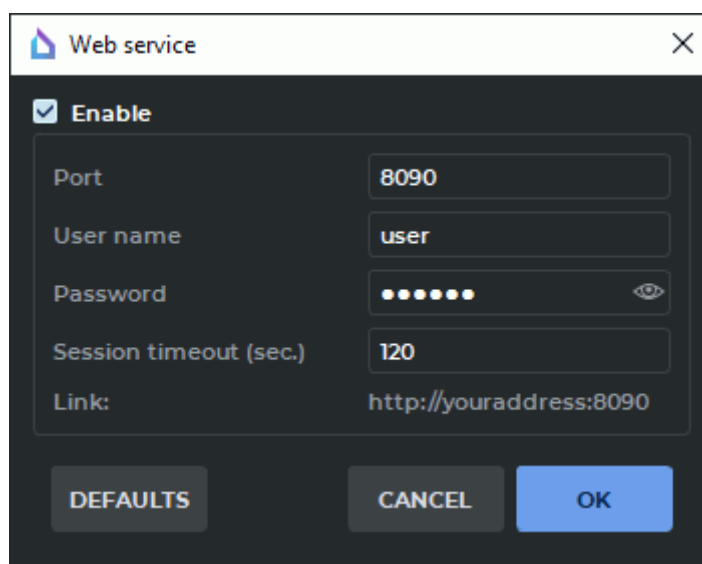

Figure 13.3: Web service dialog box

To set up the Web access:

1. Check the **Enable** box.
2. In the **Port** field under the **Enable web Access** checkbox, specify any free port of the computer the DICOM Viewer is installed on. If you are not sure which value to specify, use the default value. The default port number is 8090. For access from other computers, add the web access port to your firewall exceptions. If necessary, contact your system administrator.
3. In the **User name** field, enter the user name.
4. In the **Password** field, enter the user password.
5. In the **Session timeout (sec.)** field, enter a timeout after which the session is terminated if the connection is lost. When the connection is restored, you need to enter your user-name and password again.
6. To restore the default settings, click **DEFAULTS**. By default, the **Enable** box is unchecked, and port 8090 is used.
7. Click **OK** to apply the settings or **CANCEL** to cancel.

At the bottom of the dialog, there is a link that must be entered into the browser for web access to the DICOM Viewer `http://youraddress:<port>`, where instead of `youraddress` you need to type in the ip address or the computer name on which the DICOM Viewer is installed.

### 13.1.4 Secure DICOM Listener Service

The secure DICOM listener service provides for secure data transfer over the net using the TLS protocol.

The secure DICOM listener service and the open DICOM listener service may be used simultaneously by different ports.

Select the **Services...** item from the **Network** menu. In the drop-down menu, choose the **Secure DICOM Listener...** option. The dialog box shown in Fig. 13.4 will pop up.

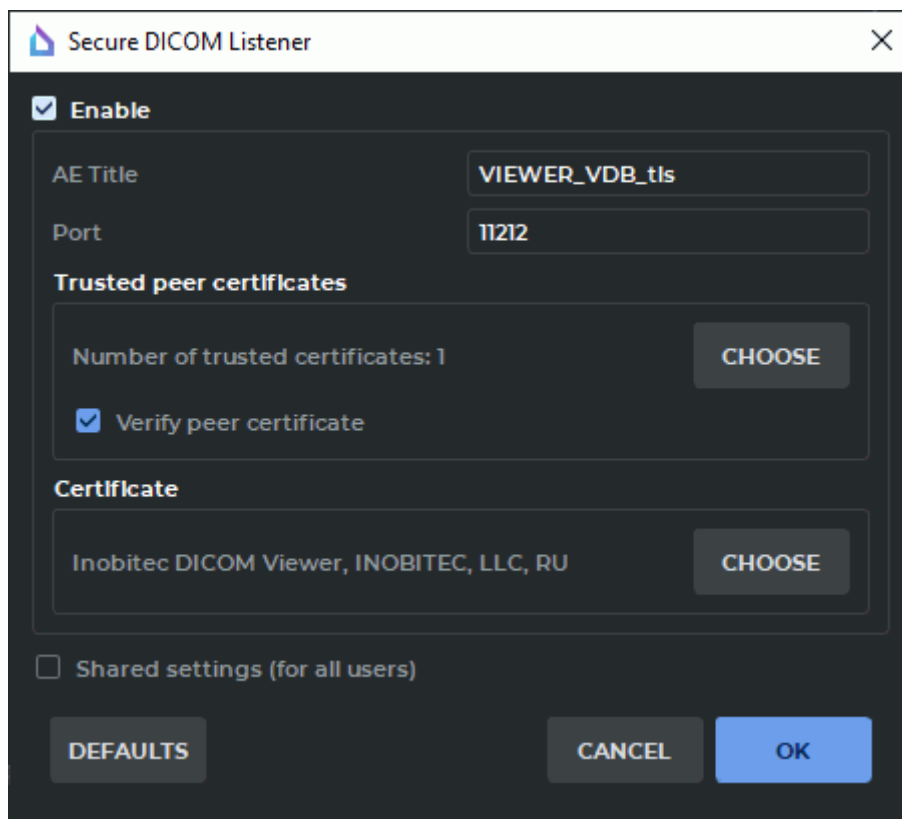

Figure 13.4: Secure DICOM Listener dialog box

To set up the Secure DICOM Listener Service:

1. To enable the secure DICOM listener service, check the **Enable** box.
2. In the **AE Title** field, print an arbitrary name of the computer with the DICOM Viewer installed for identification on the server. The length of AE Title value shall not exceed 16 characters. Cyrillic letters and «\» symbols in AE titles are not allowed.
3. In the **Port** field, specify any unoccupied port of the computer with the DICOM Viewer installed. The port number must be different from the values stated for other services

(such as Web Service, HIS/HTTP Service, DICOM Listener Service). The default port number is 3100.

4. In the **Trusted peer certificates**, a list of trusted (root) certificates for the DICOM service is created. By default, the list is empty.

A trusted certificate (root certificate) is a public key certificate which is used to sign the peer certificate. It is used to confirm the identity of the peer (the unit on the other end of the line).

To create a list of trusted certificates, click the **CHOOSE** button. In the **Trusted peer certificates** dialog box (Figure 13.5), the list of trusted certificates is provided.

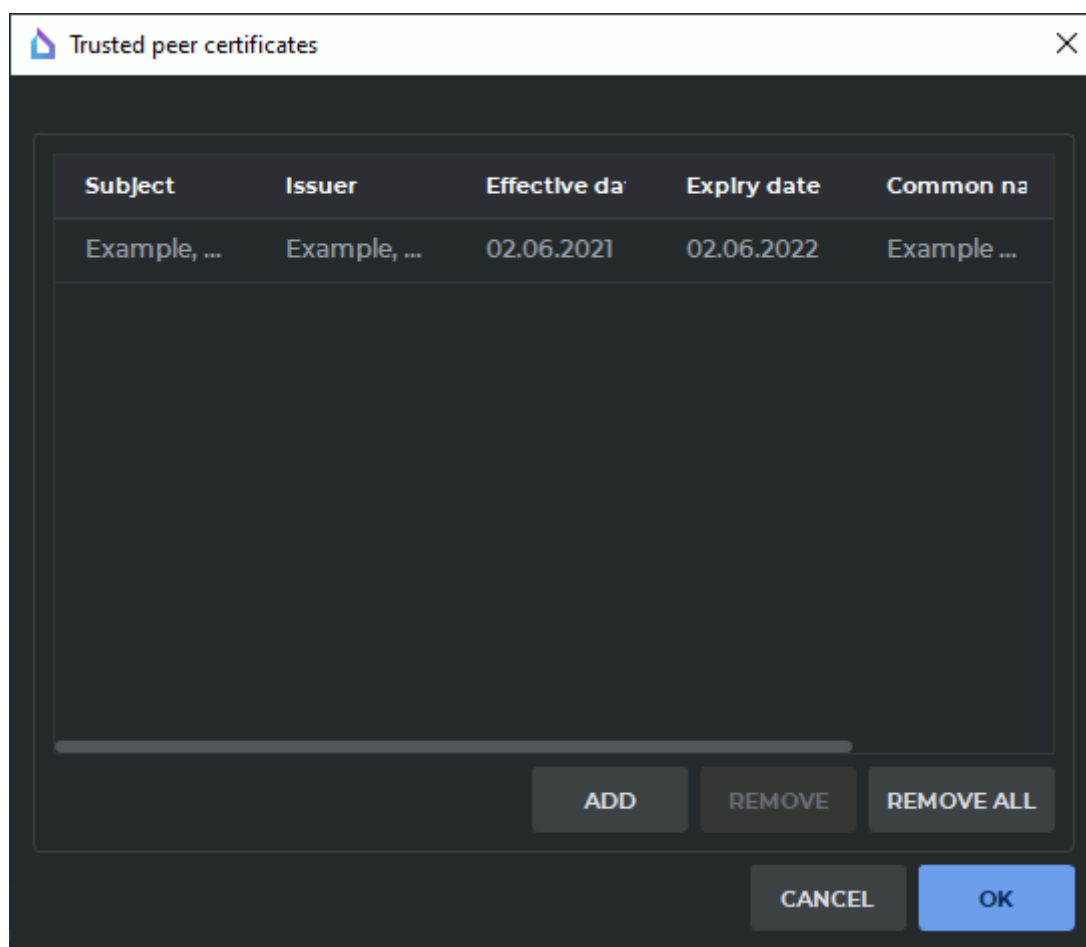

Figure 13.5: Trusted peer certificates dialog box

To add a certificate, click **ADD**. In the dialog box that pops up, choose the certificate file. Certificate files must have (pem), (crt), or (cer) extension.

In Figure 13.5, you see that the file «root\_Example.crt» is added to the trusted certificates list. It is the server root certificate.

If the certificate you are trying to add has already been added to the list, an error message will pop up.

To delete a certificate from the list, highlight the respective line and click **REMOVE**. To delete all the trusted certificates, click **REMOVE ALL**.

Click **OK** to apply the settings or **CANCEL** to cancel.

The trusted certificates added to the list are saved in the OS registry or in the configuration file as binary data. After the settings are saved, there is no need to keep the certificate files on the disk.

To enable verification of the certificates of the clients connected, check the **Verify peer certificate** box. In this case, when a secure connection to the DICOM service is established, authentication of the client is performed. For successful authentication, the client's certificate has to be signed by one of the trusted DICOM Service certificates. If the **Verify peer certificate** box is not checked, the secure DICOM Service accepts any client connections.

5. In the **Certificate** box, the paths to the public key certificate files and DICOM listener service private key files are to be provided. By default, these paths are not provided.

A public key certificate is an electronic document containing the public key, the information about the key owner and its intended use. The certificate is signed by the certification authority having issued the key and proves that the public key belongs to its owner.

The public key is available to anyone. It is used to encrypt data when the client establishes a connection with the server.

The private key is kept at the server. It is used to decrypt data received from the client.

To provide the paths to the public key certificate file and the private key file, click **CHOOSE**.

To provide the paths to the public key certificate file and the private key file, click **BROWSE** in the **Certificate and private key** dialog box (see Figure 13.6). In the box that pops up, choose the files you need. The public key certificate file must have (pem), (crt), or (cer) extension. The private key file must have (key) extension.

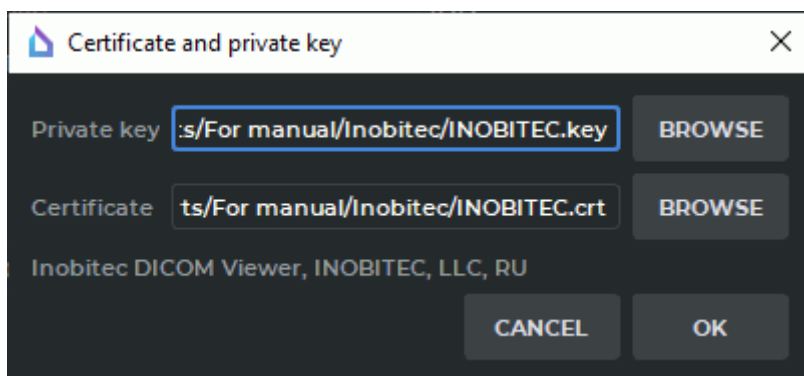

Figure 13.6: Certificate and private key dialog box

In our example shown in Figure 13.6, we have added the paths to the client's private key file «INOBITEC.key» and the public key certificate file «INOBITEC.crt».

In the lower part of the **Certificate and private key** dialog box, you see the verification status of the public key certificate and the private key. Here are the possible variants of the verification status:

- **No certificate** — the path to the public key certificate file has not been provided.
- **No private key** — the path to the private key file has not been provided.
- **Incorrect certificate** — the path provided is invalid / the file for which the path has been provided does not exist / the file for which the path has been provided is damaged or does not contain a valid public key certificate.
- **Incorrect private key** — the path provided is invalid / the file for which the path has been provided does not exist / the file for which the path has been provided is damaged.
- Data in the following format: **<Certificate name>**, **<Company name>**, **<Country abbreviation>** — the public key certificate and the private key provided is valid.



**Attention! You cannot check the compatibility of the public key certificate file with the private key in the Certificate and private key dialog box.**

The OK button will be activated after you provide the valid paths to the public key certificate file and the private key file. Click **OK** to apply the settings or **CANCEL** to cancel.

6. To save the current settings for all the users of this PC, check the **Shared settings (for all users)** box. It can only be done if the DICOM Viewer was launched by a user with administrator privileges. The users who do not have administrator privileges cannot check or uncheck this box. In such a case an error message will pop up.
7. To restore the default settings, click **DEFAULTS**.
8. Click **OK** to apply the settings or **CANCEL** to cancel.

## 13.2 Set Up PACS Server Connection

In this window, you can set up the connections with the applications which can exchange data with the DICOM Viewer, using the DICOM protocol. In this case, the DICOM Viewer can take on the role of a PACS server and the other applications will be clients, and vice versa. Since most of the applications with which a connection can be established can take on the role of a PACS server, the connections with them are set up in this window, regardless of whether they will be servers or clients in relation to the DICOM Viewer.

To open the window to connect to PACS servers, select the **Network** menu and the **Server list** item or press **Ctrl+S**. The dialog box shown in Fig. 13.7 will pop up.

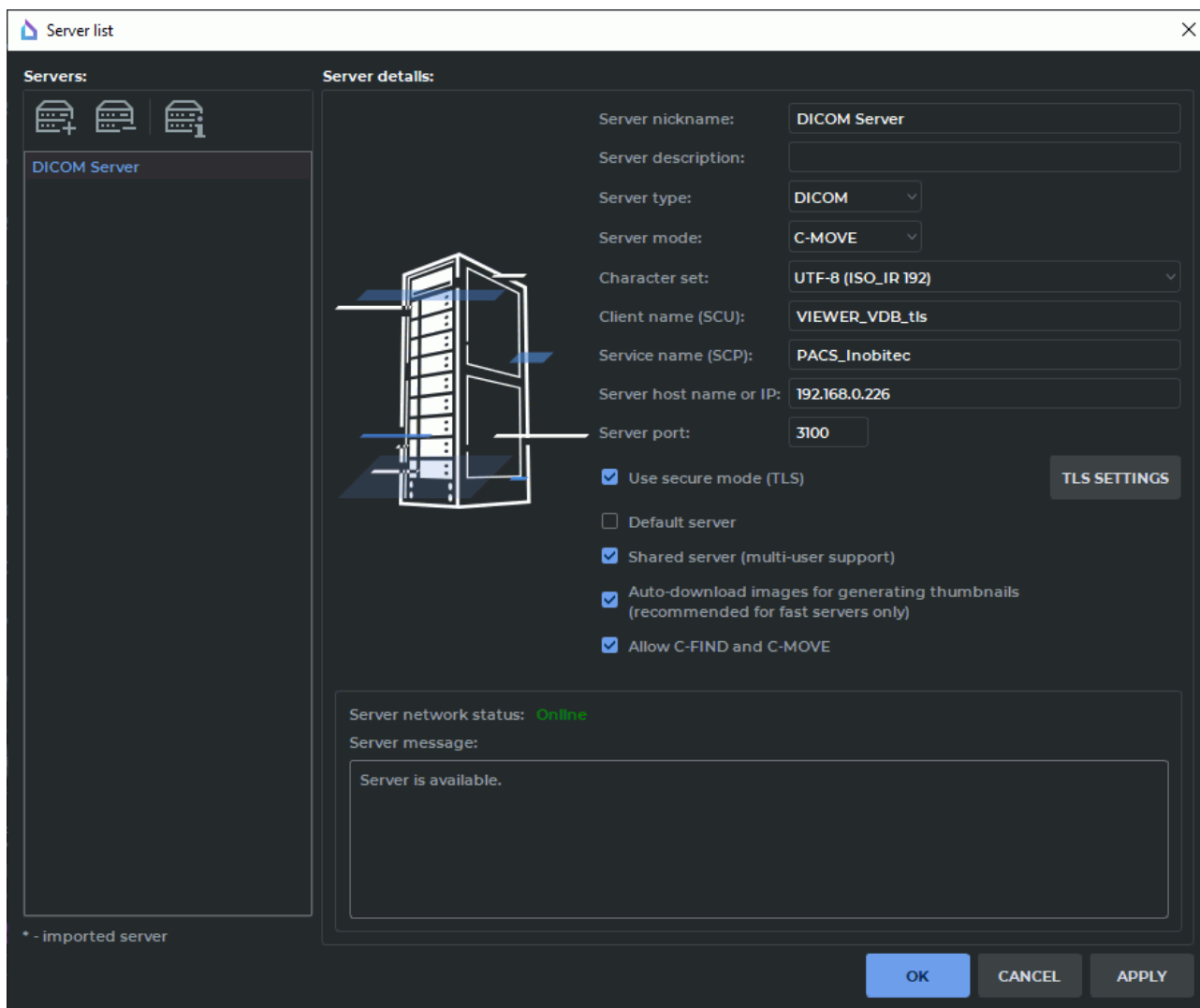



Figure 13.7: PACS server connection dialog box

The DICOM Viewer allows you to download several series from the PACS server at the same time, making several parallel connections to the PACS Server. However, not all PACS Servers support a large number of simultaneous connections, and this leads to errors when downloading data. Setting the maximum number of connections is described in 16.7.5. This setting applies to all PACS Servers.

### 13.2.1 Add PACS Server

To add a new PACS server:

1. Click the  button.
2. Enter the server name in the **Server nickname** field.
3. Enter a comment in the **Server description** field. This field may be left blank.
4. Select **DICOM** from the **Server type** dropdown menu.

5. Select the target mode from the **Server mode** dropdown menu.
6. Select the server character set from the **Character set** dropdown menu.
7. In the **Client name (SCU)** field, enter the value specified in Section 13.1.1 in the **AE Title** field.
8. In the **Service name (SCP)** field, enter the name of the server that the PACS server is installed on.
9. In the **Server host name or IP** field, enter the server name or IP address.
10. In the **Server port** field, enter the server port to accept connections by the DICOM protocol.
11. To establish a secure connection, check the **Use secure mode (TLS)** box. For details see Section 13.2.3.
12. To save the information without closing the window, click **OK**.
13. To save the information and close the window, click **SAVE**.
14. To close the window without saving the changes, click **CANCEL**.

The required information can be obtained from your system administrator. Other PACS servers are added in a similar way.

If you have several servers on your list, you can assign a server that will be active by default when starting the DICOM Viewer. To do this, check the **Default server** box in the server connection settings.

If another default server is already assigned, its box will be unchecked when you assign a new server.

If this server is also a client in relation to the DICOM Viewer, it is necessary to allow it to exchange data. To do this, check the box **Allow C-FIND and C-MOVE**. Configure the client application in accordance with the User Manual of this application. The connection configuration of two «Inobitec DICOM Viewer» applications is described in section 13.2.5.

To make the server available to all the users, you need to check the **Shared server (multi-user support)** box for this server. To do that, you need to run the DICOM Viewer as an administrator. Otherwise the box will be inactive. The users that do not have the administrator privileges cannot change the public server settings or delete it.

To delete a server from the list, click the  button.



**Attention! After you click this button, the deletion cannot be undone.**

### 13.2.2 Downloading Data from the PACS Server via WADO service

The DICOM Viewer provides an opportunity to download studies and separate series from the PACS server via **WADO** web service. Studies at the PACS server are found with command C-FIND.

To enable access to the PACS server via WADO service, in the PACS server connection dialog box (Fig. 13.7) choose **WADO-RS** from the **Server mode** drop-down list. When choosing the WADO-RS mode, you will see the **WADO settings** dialog box (Fig. 13.8).

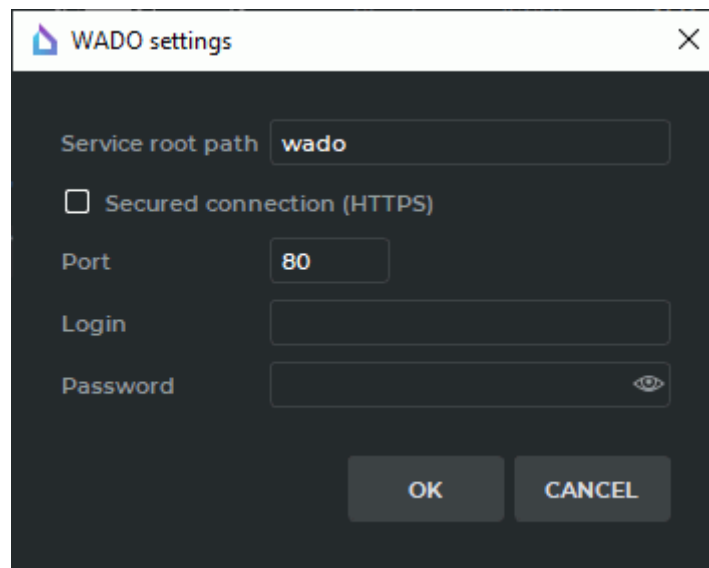

Figure 13.8: WADO settings dialog box

Set up the connection:

- in the **Service root path** field, provide the path to the PACS server internal service processing WADO-RS queries. The field is empty by default;
- the **Secured connection (HTTPS)** box is used to enable/disable the https protocol for communication with the PACS server when downloading data via WADO service. The box is unchecked by default. If the box is checked, the https protocol is used to communicate with the PACS server; if it is unchecked, the http protocol is used;
- in the **Port** field, provide the value of the http or the https port (depending on the **Secured connection (HTTPS)** box status) within the range from 1 to 65535. The default value is 80. If an invalid value is entered, the **OK** button will be blocked;
- in the **Login** and **Password** fields, provide the data to connect to the PACS server. The fields are empty by default.

Click **OK** to apply the changes or **CANCEL** to cancel.

To change the current WADO service connection parameters, click the **SETTINGS** button next to the **Server mode** drop-down list in the **Server list** dialog box (see Fig. 13.7).

WADO service settings may be exported and imported (see Section 16.9). The data to connect to the PACS server (login and password) are not saved when the settings are exported.

### 13.2.3 Secure PACS Server connection via the TLS protocol



If you launch the DICOM Viewer 2.4 or an inferior version of the program on your PC, all the TLS parameters will be reset.



By default, the AE Title of the secure connection via the TLS protocol is the same as the AE Title of the non-secure connection. Hence, it is recommended to change the name in the settings window. The secure TLS connection service and the non-secure connection may be used simultaneously by different ports.

To enable the secure connection mode, check the **Use secure mode (TLS)** box in the server parameters dialog box (see Figure 13.7). By doing this, you will activate the **TLS SETTINGS** button for secure mode setup.

The **TLS SETTINGS** dialog box is shown in Figure 13.9.

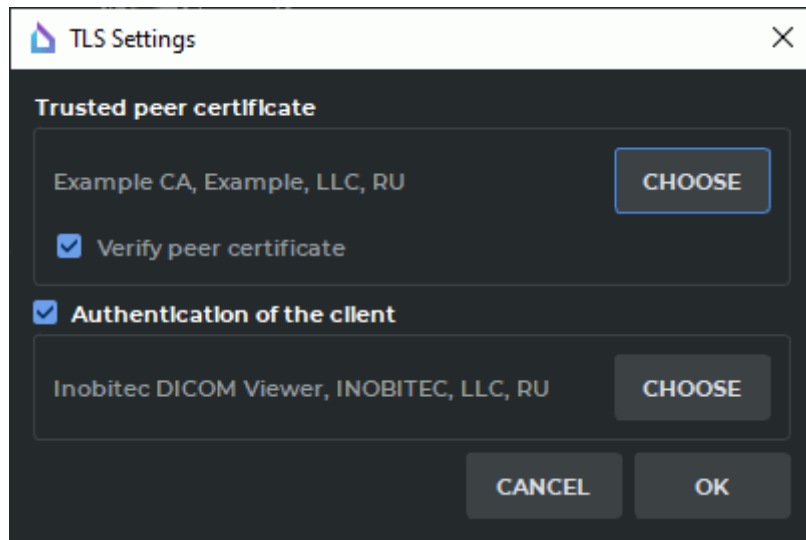

Figure 13.9: TLS Settings dialog box

To add a trusted peer certificate, click **CHOOSE**. In the dialog box that pops up, choose the trusted (root) PACS Server certificate file. The trusted (root) PACS Server certificate file must have (pem), (crt), or (cer) extension.

In our example, the root certificate file «root\_Example.crt» is being added.

To enable verification of the trusted (root) certificate at the time of establishing a connection with the PACS Server, check the **Verify peer certificate** box. In this case, when a connection is being established, the client's authentication is performed. For successful authentication, the PACS Server certificate has to be signed by a trusted certificate.

The program automatically checks the presence of a valid certificate in the file. If the file is damaged or does not contain a certificate, a message will pop up.

If you have chosen the file containing the valid certificate, you will see the following information in the **Trusted peer certificate** box: <Certificate name>, <Company name>, <Country abbreviation>.

If the peer certificate verification mode has been enabled on the PACS Server, the client's authentication must be performed to establish a connection. Check the **Authentication of the client** box and click **CHOOSE**.

In the **Certificate and private key** dialog box (Figure 13.10), the paths to the public key certificate file and the private key file are provided.

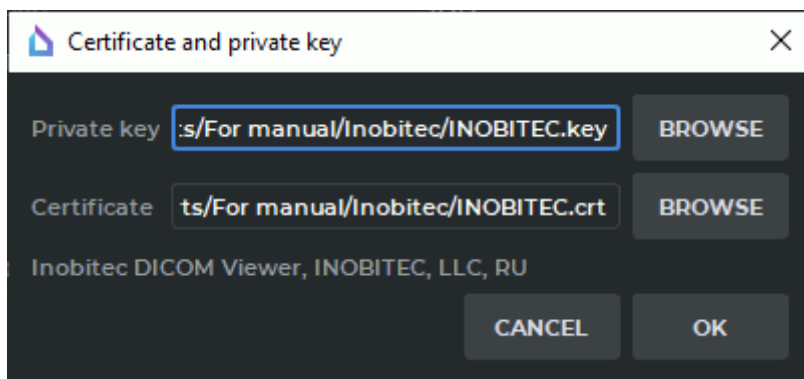

Figure 13.10: Certificate and private key dialog box

To provide the paths to the public key certificate file and the private key file, click **BROWSE**. In the box that pops up, choose the files you need. The public key certificate file must have (pem), (crt), or (cer) extension. The private key file must have (key) extension.

In our example shown in Figure 13.10, we have added the paths to the client's private key file «INOBITEC.key» and the public key certificate file «INOBITEC.crt».

In the lower part of the **Certificate and private key** dialog box, you see the verification status of the public key certificate and the private key. Here are the possible variants of the verification status:

- **No certificate** — the path to the public key certificate file has not been provided.
- **No private key** — the path to the private key file has not been provided.
- **Incorrect certificate** — the path provided is invalid / the file for which the path has been provided does not exist / the file for which the path has been provided is damaged or does not contain a valid public key certificate.
- **Incorrect private key** — the path provided is invalid / the file for which the path has been provided does not exist / the file for which the path has been provided is damaged.
- Data in the following format: **<Certificate name>**, **<Company name>**, **<Country abbreviation>** — the public key certificate and the private key provided is valid.



**Attention! You cannot check the compatibility of the public key certificate file with the private key in the Certificate and private key dialog box.**

The OK button will be activated after you provide the valid paths to the public key certificate file and the private key file. Click **OK** to apply the settings or **CANCEL** to cancel.

### 13.2.4 Check PACS Server Availability

To check if the server is available, click the  button in the PACS server connection window. If the server is available, the system will return the following message: **Server network status: Online.**

Otherwise the following message will be returned: **Server network status: Offline**.The error details will be displayed below.

```
Server is unavailable.
Connection request failed.
Failed to establish association
0006:0317 Peer aborted Association (or never connected)
0006:031c TCP Initialization Error: No error
```

If a message similar to the one shown below appears, it, most likely, means that the **Server host name or IP** or **Server port** fields are filled in incorrectly, or the target PACS server is not running.

### 13.2.5 Configuring the connection of two applications Inobitec DICOM Viewer

Let's assume that DICOM Viewer #1 takes on the role of a PACS-server and DICOM Viewer #2 takes on the role of a client.

Parameters of DICOM Viewer #1:

- **AE Title:** VIEWER-SERVER;
- **IP:** 192.168.1.101;
- **Port:** 3001.

Parameters of the DICOM Viewer #2:

- **AE Title:** VIEWER-CLIENT;
- **IP:** 192.168.1.102;
- **Port:** 3002.

To configure the server:

1. Enable and set up the DICOM service (section 13.1.1), set **AE Title** as VIEWER-SERVER, set **Port** as 3001.
2. Add a client in the **Set Up PACS Server Connection** window (section 13.2.1). Set the following parameters for the fields:
  - for field **Server type** — DICOM;
  - for field **Server mode** — C-MOVE;
  - for field **Client name (SCU)** — VIEWER-SERVER;
  - for field **Service name (SCP)** — VIEWER-CLIENT;
  - for field **Server host name or IP** — 192.168.1.102;
  - for field **Server port** — 3002;
  - check the box **Allow C-FIND and C-MOVE**.

Now, DICOM Viewer #1 is ready to accept incoming connections from the client with the AE Title = VIEWER-CLIENT, IP = 192.168.1.102 and port=3002.

To set up a client:

Add the server in the **Set Up PACS Server Connection** window(section 13.2.1). Set the following parameters for the fields:

- for field **Server type** — DICOM;
- for field **Server mode** — C-MOVE;
- for field **Client name (SCU)** — VIEWER-CLIENT;
- for field **Service name (SCP)** — VIEWER-SERVER;
- for field **Server host name or IP** — 192.168.1.101;
- for field **Server port** — 3001;

Now DICOM Viewer #2 is ready to connect to the server with AE Title = VIEWER-SERVER, IP = 192.168.0.101 and port=3001.

If you enable and set up the DICOM-service and check the box **Allow C-FIND and C-MOVE** for the VIEWER-SERVER server in the DICOM Viewer #2 settings, then DICOM Viewer #2 will be able to take on the role of a server and DICOM Viewer #1 will be able to take on the role of a client. Thus, the DICOM Viewer can take on the role of a client and a server simultaneously.

### 13.3 Network Operation Status

Network operations refer to information transfer and reception between the DICOM Viewer and the PACS servers.

To view the network operation status, select the **Network** menu and the **Network status** item.

The window contains three tabs: **Downloading**, **Uploading** and **History**. The **Downloading** and **Uploading** tabs display the queues of studies loaded from the PACS server or sent to the PACS server respectively.

If some data is being transferred at the moment, the study queue will be displayed in the corresponding tab (Fig. 13.11). The studies positioned at the top of the list are the first to be processed.

Patient	Study	Series	Objects	Status
aab5029cb5ab28fb28d...	2014-05-20, ABDOMEN+C	Series #2, CT, Pre Contrast anonymized	29 of 84	Processing
aab5029cb5ab28fb28d...	2014-05-20, ABDOMEN+C	Series #3, CT, Recon 2: Pre Contrast ano...	39 of 333	Processing
aab5029cb5ab28fb28d...	2014-05-20, ABDOMEN+C	Series #7, CT, ARTER 0.625 anonymized	33 of 257	Processing
aab5029cb5ab28fb28d...	2014-05-20, ABDOMEN+C	Series #8, CT, VEN 0.625 CSI anonymized	17 of 257	Processing
e7594edaclca67a2b81...	2006-12-07, Cardiac^Cardiac_S...	Series #1, CT, CorCTA 0.6 B20f 65% dias ...	39 of 414	Processing
e7594edaclca67a2b81...	2006-12-07, Cardiac^Cardiac_S...	Series #2, CT, CorCTA 3.0 B20f 0-90% 10...	41 of 530	Processing
e7594edaclca67a2b81...	2006-12-07, Cardiac^Cardiac_S...	Series #3, PT, pet cardiac 10 gates Volu...	29 of 810	Processing
7d0a65955565fb9b1576...	2014-06-11, Dual Energy^DE_C...	Series #1, CT, DE DE_CarotidAngio 1.0 D...	18 of 415	Processing
7d0a65955565fb9b1576...	2014-06-11, Dual Energy^DE_C...	Series #2, CT, DE DE_CarotidAngio 1.0 ...	16 of 415	Processing
23d5c51afade7a870118...	2008-07-01, CAT SCAN ABDOM...	Series #1, CT, abd 1mm anonymized	8 of 889	Processing
e7594edaclca67a2b81...	2006-12-07, Cardiac^Cardiac_S...	Series #1, CT, CorCTA 0.6 B20f 65% dias ...	0 of 414	Queued
e7594edaclca67a2b81...	2006-12-07, Cardiac^Cardiac_S...	Series #2, CT, CorCTA 3.0 B20f 0-90% 10...	0 of 530	Queued
e7594edaclca67a2b81...	2006-12-07, Cardiac^Cardiac_S...	Series #3, PT, pet cardiac 10 gates Volu...	0 of 810	Queued
23d5c51afade7a870118...	2008-07-01, CAT SCAN ABDOM...	Series #1, CT, abd 1mm anonymized	0 of 889	Queued

Figure 13.11: Queue of studies sent to the PACS server

When using the **Downloading** and **Uploading** tabs, the same actions are used. The following actions with a study can be performed (select a study first):

- change the position in the queue, using the and buttons respectively;
- cancel the study processing, using the button. In this case, only the information that is already loaded will remain on the server.

To clear the queue, click the button. In this case, the studies, including the one currently processed, are deleted from the list, and their processing is interrupted. If a study is already being processed (**In progress** status), you cannot change its position in the queue.

The top of the **History** tab displays the list of studies loaded, sent or canceled. At the bottom of the tab, there is a list of studies whose transfer failed.

# Chapter 14

## The Local Storage

The storage is a folder on the computer disk where the DICOM data is stored.



**The data kept in the local storage may be lost through the hard drive damage, improper users' activities, or third-party software impact. To avoid data loss, back up the data.**

### 14.1 View Storage Status

To view the storage status, select the **Storage** menu and the **Storage status...** item. The window shown in Fig. 14.1 will pop up.

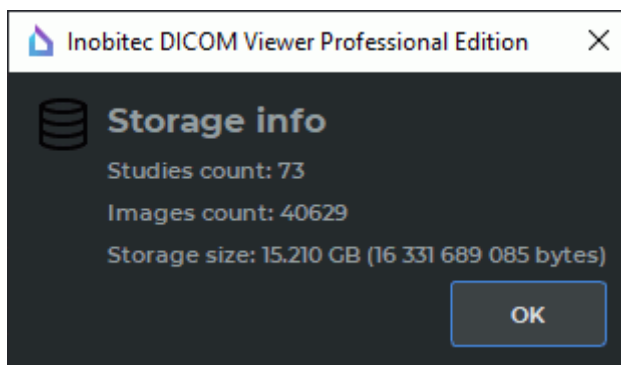

*Figure 14.1: Storage info*

The following information is displayed in the window: the number of studies in the storage; the total number of images in all studies; the size of data stored in the storage (gigabytes and bytes).

## 14.2 Verify Storage

To check the storage, select the **Storage** menu and the **Verify storage...** item. The checking process shows whether all images related to the studies are located in the storage. The checking progress (percentage of work performed) is displayed on the screen.

If all the files are found in the storage, the **All files in storage are valid** message will be displayed.

If any of the files are not found in the storage, the message like **Found 10 missed files in the local storage. Please, try again to download studies.** will be returned. In this case, you need to reload all the studies to the storage to display all the images properly. To clear the storage, perform the actions described in the next section.

## 14.3 Clear Storage

To clear the storage, select the **Storage** menu and the **Clear storage...** item. In this case, the **All local studies will be deleted. Do you really want to clean up the local storage?** message will be displayed. Click **YES** to clear the storage or **NO** to cancel. After the storage is cleared, click **OK** in the clearing progress window.

## 14.4 Automatic Local Storage cleaning

Automatic cleaning is performed at the following intervals:

- every time;
- once a day;
- once a week;
- once a month.

To activate/deactivate automatic cleaning, check/uncheck the **Automatic local storage cleaning** box and select the cleaning interval (see section [16.7.6](#)).

# Chapter 15

## Disk Creator

### 15.1 General information

The disk creator allows you to write information to CDs, DVDs and Memory Cards. To open the disk creator, click the **DICOM CD/DVD Creator**  button on the toolbar. To select the tab location (in the current window, in a separate window or in the full screen mode), click on the arrow on the right side of the button. To open the creator window in a new tab in the current window, click on the button.

The disk creator window is shown in Fig. 15.1.

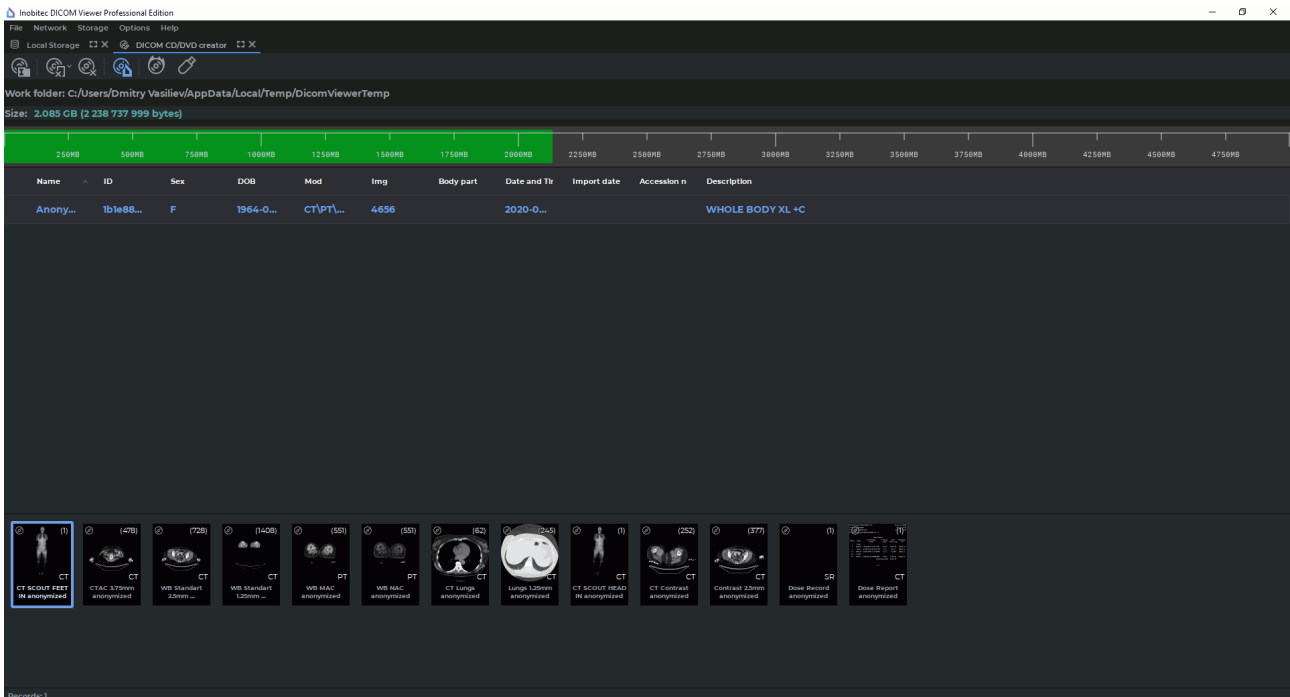



Figure 15.1: Disk creator









To work with the creator, the Work Folder should be set up, i.e. the folder to store the disk image to be written. By default, the Work Folder is located in the temporary folder of the operating system. To change it, click on the **Select the work folder where DICOM CD/DVD image will be created**  button and select the directory in the dialog that opens. If, when opening the creator, the Work Folder already contains data, then the dialog with the question **Do you want to clear work folder before inserting new data?** is displayed. Click **YES** to clear or **NO** to leave the data.

If the disk image is damaged, it may become impossible to work with it. If errors occur when adding or removing data, manually clean the Work Folder.

After being written, the data in the Work Folder can be saved for later use or it can be automatically deleted. Automatic cleaning of the Work Folder can be enabled before burning the image (see Section 15.3).

The top part of the creator contains the control buttons:

	<b>Select a work folder where DICOM CD/DVD image will be created</b> is used to change the Work Folder.
	<b>Remove series from the DICOM CD/DVD image:</b> to delete the selected series, click on the button. To delete the selected study, click on the arrow on the right side of the button and select the <b>Remove studies</b> command.
	<b>Clear DICOM CD/DVD image</b> deletes all studies from the image.
	The <b>Include Inobitec DICOM Disc Viewer to the DICOM CD/DVD image</b> button described in Section 15.2.3.
	<b>Burn created DICOM CD/DVD image to the optical disk</b> writes information from the creator to the disk.
	<b>Write created DICOM CD/DVD image to the flash card or folder</b> writes information from the creator to the memory card (flash card) or folder.

The **Size** parameter displays the size of the disk image. The same information is duplicated by the green bar on the graph (Fig. 15.2).

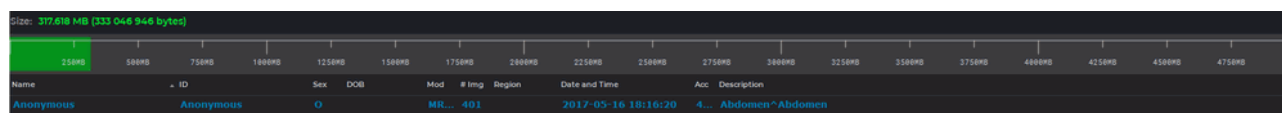

Figure 15.2: Disk Image size

## 15.2 Add Data to Disk Creator

### 15.2.1 Automatically Add Data to a Disk Image

Since version 1.14.0, it is possible to automatically add data to a disk image.

To set up automatic adding of studies select the main menu **Options->Settings...->Modules->DICOM CD/DVD Creator** and click the **Settings** button. In the window that opens check the **Add selected studies at opening DICOM CD/DVD Creator** box. By default the box is checked. Click **OK** to apply the settings or **CANCEL** to cancel.



To add studies to the disk image automatically:

1. Load studies to the DICOM Viewer.
2. Select the required study (several studies, holding down the **Shift** or **Ctrl** keys. For more information, see Section 1.9).
3. Click the **DICOM CD/DVD Creator**  button on the toolbar. If the creator is closed, it opens, and the selected studies are added to the image.

If the **Work Folder is not set. Choose Work Folder and try again** error occurs, then set the Work Folder for the creator (see Section 15.1), or it will be automatically created in the temporary folder of the operating system the next time you start the Disk Creator.

### 15.2.2 Manually Add Data to a Disk Image

To add studies or series to the disk image manually:

1. Load studies to the DICOM Viewer.
2. Select the required study (or several studies, holding down the **Shift** or **Ctrl** key. For more information on how to select several studies, see Section 1.9).
3. To add an entire study to the disk image, click the **Add selected studies to DICOM CD/DVD image**  button on the Studies Import/Export Panels.
4. To add a series, select it on the series panel and click on the left part of the **Add selected series to DICOM CD/DVD image**  button on the Series Import/Export Panels. The information will be added to the creator. To select several series, hold down the **Shift** or **Ctrl** keys. For more information, see Section 1.9).

If the **Work Folder is not set. Choose Work Folder and try again** error occurs then set the Work Folder for the creator (see Section 15.1) or it will be automatically created in the temporary folder of the operating system the next time you start the Disk Creator.

### 15.2.3 Adding the Inobitec DICOM Disc Viewer to the Disk Image

To be able to view the images recorded on the disk without having to install special software, add the **Inobitec DICOM Disc Viewer** to the disk image. It requires no installation and runs directly from the disk on Windows and macOS.

To add the **Inobitec DICOM Disc Viewer** to the disk image, click the **Include Inobitec DICOM Disc Viewer to the DICOM CD/DVD image**  button. When cleaning the disk image the **Inobitec DICOM Disc Viewer** is stored in the disk image.

To remove the **Inobitec DICOM Disc Viewer** from the disk image, click the  button. In the dialog box that opens, click **YES** to confirm the deletion or click **NO** to cancel.

## 15.3 Burn image

If you need to write a DICOMDIR file to a disk (memory card), enable the corresponding option in the Dick Creator settings dialog (see Section 16.7.7).

Data burning may fail for some models of CD/DVD-ROMs. To increase the reliability of recording enable image buffering (see Section 16.7.7). In this case, the buffer file for writing is created entirely in the temporary folder of the current user just before writing to disk. Buffer files are created before each recording and are deleted from the hard disk only when the DICOM Viewer is closed. Hence, the amount of free space on the hard disk should be taken into account when writing to the disk multiple times within one session of the program.

### 15.3.1 Write to Disk



**Attention! In Linux and macOS you can write data to a memory card or burn a disk image created in the Work Folder to a disk, using the operating system tools.**

More detailed information in the Section 15.3.3.

To write information to a disk:

1. Click the **Burn created DICOM CD/DVD image to the optical disk**  button on the Disk Creator toolbar. The window shown in Fig. 15.3 will pop up.
2. If necessary, select the recorder device from the dropdown menu.
3. Edit the disk name if necessary.
4. If necessary, check/uncheck the **Set minimal write speed** box.
5. If necessary, check/uncheck the **Automatically clean up the DICOM CD/DVD image after burning disk** box.
6. Click **OK** to write or **CANCEL** to cancel.

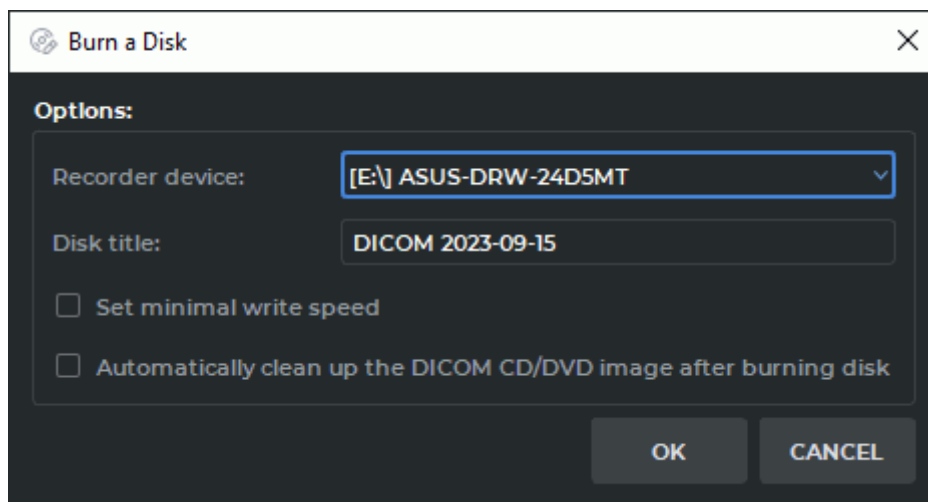

Figure 15.3: Writing parameters

If the **Automatically clean up the DICOM CD/DVD image after burning disk** box is checked, the information stored in the Work Folder of the creator will be deleted. Otherwise you will be able to record it again.

### 15.3.2 Write to Memory Card or Folder

To write information to a memory card (flash card) or folder:

1. Click the **Write created DICOM CD/DVD image to the flash card or folder**  button on the Disk Creator toolbar. Dialog box is shown in Figure 15.4.

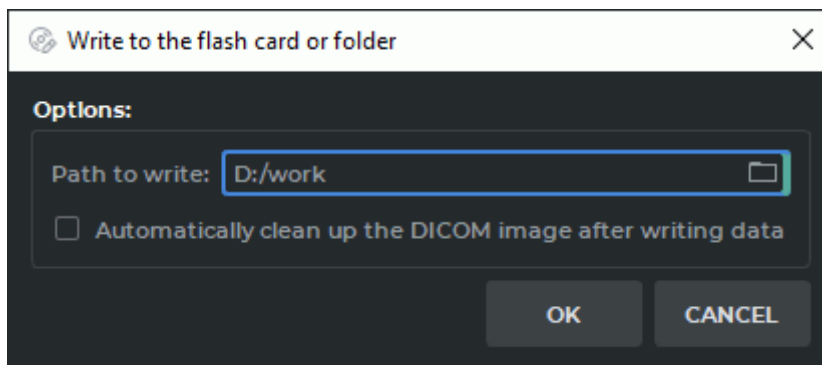



Figure 15.4: Write to the flash card or folder dialog box

2. Select a memory card or folder on your hard disk. To do this, enter the path in the **Path to write** field or click the  button and select the path in the dialog that opens.
3. If necessary, check/uncheck the box **Automatically clean up the DICOM CD/DVD image after writing data**.
4. Click **OK** to write or **CANCEL** to cancel.

### 15.3.3 Burn an image to CD / DVD in Linux and macOS operating systems

To write information to a disk:

1. The Work Folder should be created, i.e. the folder to store the disk image to be written.
2. Save the information to the created directory, in accordance with the Section [15.3.2](#).
3. Burn a disk image created in the Work Folder to a CD/DVD using the operating system tools or special applications.

## 15.4 View studies written on disk

Insert a disk or memory card with DICOM data and the **Inobitec DICOM Disc Viewer** into the computer. If autorun of disks and cards is enabled on the computer, the **Inobitec DICOM Disc Viewer** will start automatically. Otherwise, on Windows run the *Start\_Win* file, on macOS run the *DICOMViewer* file. Both files are located in the root directory of the disk or card.

The written studies are automatically displayed on the Study Panel.

## Chapter 16

# DICOM Viewer Settings

To change the settings, select the **Options** menu and the **Settings...** item. The window shown in Fig. 16.1 will pop up.

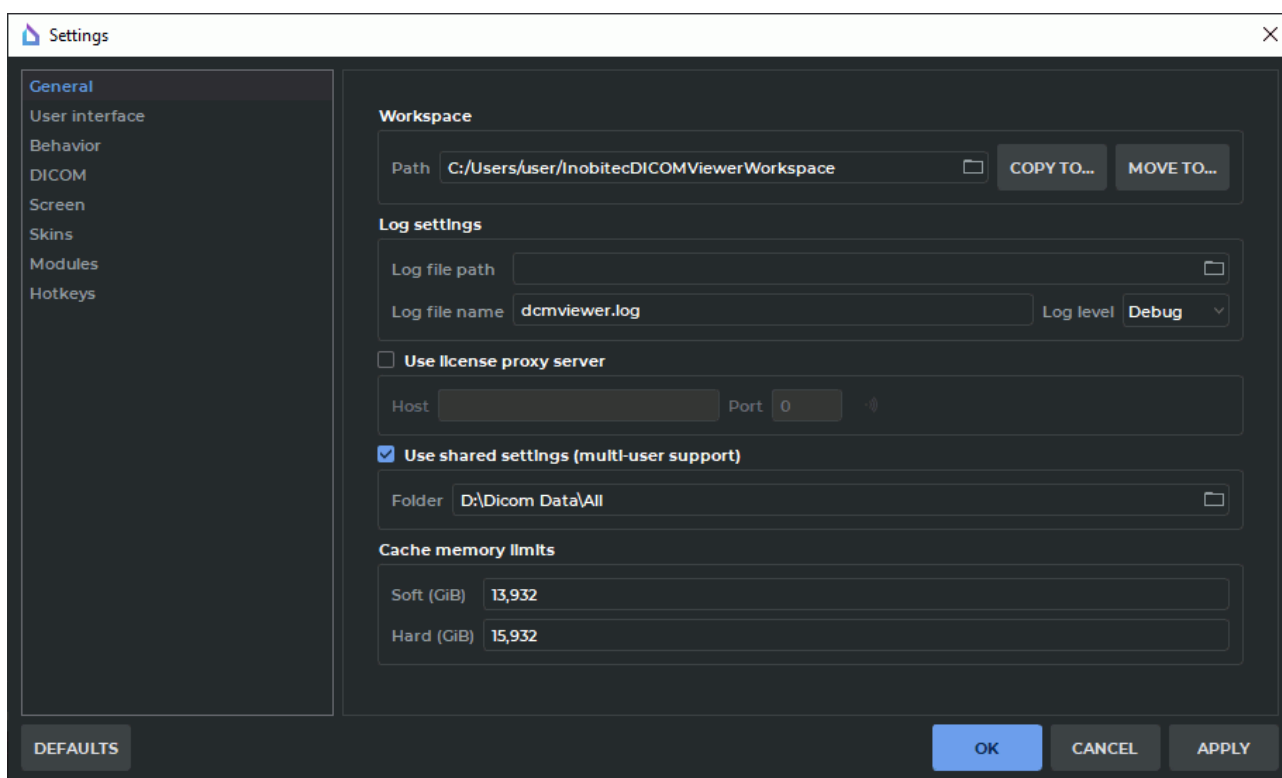

Figure 16.1: DICOM Viewer setup window. General settings

The setup menu will be displayed on the left side of the window.

The **DEFAULTS** button allows you to restore the settings for the current window which are set upon the very first launch of the DICOM Viewer on the computer.

## 16.1 General



The following parameters are set up in this section:

- Working directory path. This is the local storage location. The path can be entered manually or selected from the dialog box. To open the dialog box, click the button to the right of the path input string.
- Log file path. The information about the DICOM Viewer operation is saved in the log. The path can be entered manually or selected from the dialog box. To open the dialog box, click the button to the right of the path input string. If the parameter is not specified, the log file will be located in the directory where the DICOM Viewer is installed.
- Log file name.
- DICOM Viewer log specification. The following specification levels are available:
  - **Failure:** registering information about errors that led to the DICOM Viewer failure;
  - **Error:** registering information about all errors that may lead to the incorrect operation of the DICOM Viewer;
  - **Warning:** registering all errors, whether or not they might lead to the incorrect operation of the DICOM Viewer;
  - **Info:** registering all errors as well as standard actions of the DICOM Viewer;
  - **Debug:** registering all errors and standard DICOM Viewer actions with detailed information.

After changing the logging level, you do not need to restart the program.

- Use License Proxy Server (the **Use License Proxy Server** box) and its parameters. To check the availability of the server, click the button  after you have filled in the **Host** and **Port** fields. The information will be displayed on the right.
- Use a shared folder to store service information (the **Use shared settings (multi-user support)** box) and path to a shared folder.
- Customize the cache memory limits. You may provide for a soft and a hard limit.
  - In the **Soft** field, specify the maximum volume of cache to be used by the program before it makes an attempt to clear the memory by deleting the data that are not used. The default value is determined automatically on the basis of the amount of RAM on the device with the DICOM Viewer installed.
  - In the **Hard** field, specify the maximum volume of cache that can be allocated for cached data. The default value is equal to the amount of RAM on the device with the DICOM Viewer installed.

The cache memory limit is specified in Gibibytes (GiB), accurate to a thousandth, from 0.125 to 999999999999.999. Its value must not exceed the memory size. If you attempt to set a limit exceeding the memory size, a warning message will pop up. The value provided in the **Hard** field must be greater than the value in the **Soft** field. If the limit values fail to meet these requirements, a warning message will pop up.

The fields for setting cache memory limits are provided with a restore recommended value button . The restore recommended value button is displayed when the limit value provided is different from the recommended value. To restore the recommended value of a cache memory limit, click the  button in the respective field.

After the cache memory limits have been changed, the program must be relaunched. A dialog box will pop up notifying the user of this necessity.

## 16.2 User interface

The following parameters are set up in this section:

- Interface language. Can be chosen from the drop-down list. The respective changes will be applied after the program is restarted.
- Help language. Can be chosen from the drop-down list of the help system languages. By default, the **Auto** option is selected, and the interface language is used as the help language.

If the selected interface language is not used for the help system, English will be used as the help language. If the user didn't install the help system when installing the software, the choice of the help language will not be available.

The selected help language will be applied after the program is restarted.

- Using native OS open/save file dialogs. For Windows XP, you can use dialogs only in the DICOM Viewer style.
- Request for confirmation before closing the DICOM Viewer.
- Display Tooltips (the **ToolTips** box), Shortcuts and play Slideshows on the Tooltips. If the **ToolTips** box is unchecked, the tooltips are not displayed at all.
- Showing the patient's name on the tab stub. The patient's name is taken from the *PatientName(0010,0010)* tag. The function is enabled by default.

## 16.3 Behavior

In this section, you can set up the parameters that can alter the behavior of the program:

- **Allow to close the application running as different users.** The option is disabled by default. To activate the parameter, the DICOM Viewer has to be launched by a user with administrator privileges. Users without administrator privileges cannot check or uncheck this box. In such a case, a warning message will pop up.

It is recommended to activate the parameter if there are several user accounts in the system. After the parameter is activated, the program launched by one user may be closed during a different session by a different user.



**The parameter cannot be set up on macOS.**



- **Launch the viewer from the context menu.** The parameter enables/disables loading and opening DICOM studies in the program via the Explorer context menu. The initial setting is provided by the user in the **Extended parameters** window when installing the DICOM Viewer (see Fig. 7).



**The parameter cannot be set up on Linux or macOS.**

The parameter can be changed for the current user or for all the OS users. To change the parameter for all the users, the DICOM Viewer has to be launched by a user with administrator privileges. In this case, the parameter will be called **Launch the viewer from the context menu (for all users)**.

The parameter set for all the users can only be disabled after the program is launched by a user with administrator privileges.

- Close to tray (the **Show system tray icon** box) and minimize to tray (the **Minimize to tray** box).
- **Launch the viewer automatically when the user logs in.** The option is disabled by default.



**If several DICOM Viewer versions or editions were installed on the OS, then when the option is enabled, only the current DICOM Viewer version and edition will be launched automatically.**

If you want the DICOM Viewer to be minimized to the system tray after the automatic launch, the **Show system tray icon** and **Hide at launch (the "Show system tray icon" option must be activated)** options must be activated.

- Anonymous statistics collection (telemetry) function can be activated/deactivated. Telemetry function provides an opportunity to collect anonymous statistics in order to improve the product.

## 16.4 DICOM

The following DICOM files processing parameters are set up in this section:

- Reading character set (character set of DICOM data);
- The **Ignore parse errors** option can be checked/unchecked;
- The **Ignore file meta header length** option can be checked/unchecked;
- The **Allow reading broken files** option can be checked/unchecked;
- The **Perform color space conversion from YCbCr to RGB** option can be checked/unchecked. The option is disabled by default. The option is used when the color model provided for in the *Photometric Interpretation (0028,0004)* tag is invalid. When the option is enabled, the color space is transformed from YCbCr to RGB. When the setting is changed and saved, the program must be relaunched. A dialog box will pop up notifying that the new setting will be applied the next time the program is launched. When the program is restarted automatically, the option is not applied.

## 16.5 Screen

This section is meant for customizing the DICOM Viewer windows display on the monitors available for the OS.

### 16.5.1 Setting an Additional Monitor

The DICOM Viewer provides an opportunity to display information on several monitors, and the user does not have to move the windows manually.

To use an additional monitor, proceed as follows:

1. Select the **Options** menu and the **Settings...** item.
2. Open the **Screen** section. The window similar to the one shown in Fig. 16.2 will pop up.
3. On the **Special parameters of screen** list, select the screen(s) to be used for the DICOM Viewer. The screen status will be changed to **Used**.
4. Click **OK** or **APPLY** to apply the changes or **CANCEL** to cancel the actions. To restore default settings, click the **DEFAULTS** button.
5. The DICOM Viewer needs to restart to apply the changes. The DICOM Viewer will request confirmation before restarting: **The changes you are made requires restarting the program to take effect. Do you want to restart the application?**

If you are still working with the opened studies, or if the information needs to be saved, click **NO** to cancel the restart and set up the displays later. To restart the DICOM Viewer click **YES**.

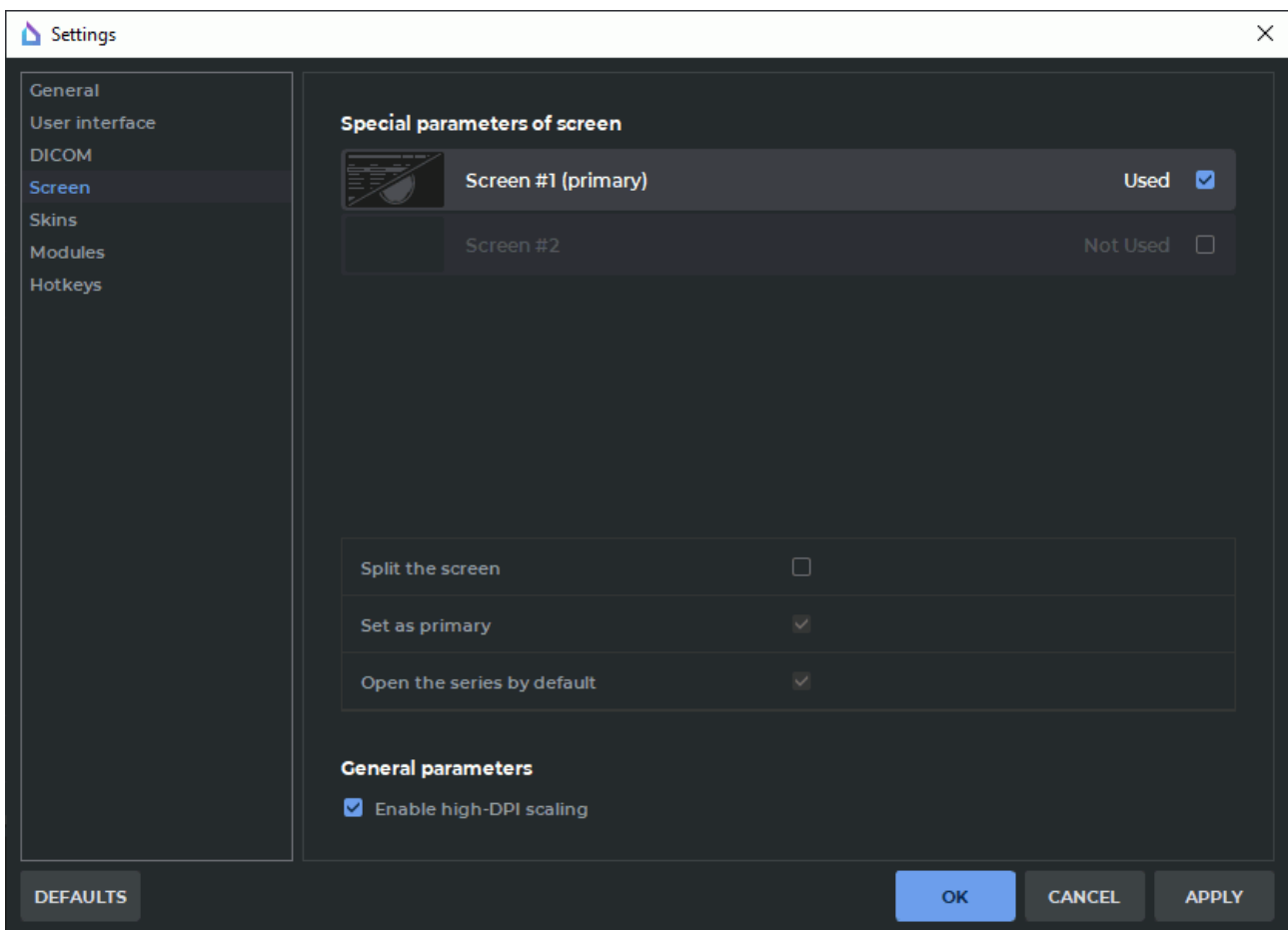

Figure 16.2: Monitor settings

If only one screen is selected, the DICOM Viewer will be opened on this screen. If more than one screens are checked, the DICOM Viewer windows are opened on the marked screens. To close the DICOM Viewer just close any of the windows.

## 16.5.2 Customizing the Screen Parameters

The DICOM Viewer provides an opportunity to divide the screen into two parts and place two windows side by side at launch.

To change special parameters of the screen, proceed as follows:

1. Select the **Options** menu and the **Settings...** item.
2. Open the **Screen** section. The window similar to the one shown in Fig. 16.2 will pop up.
3. Select the screen you want to split in the **Special parameters of screen** list. A **Not used** screen cannot be selected.
4. Check the **Split the screen** for the selected screen (see Fig. 16.3).

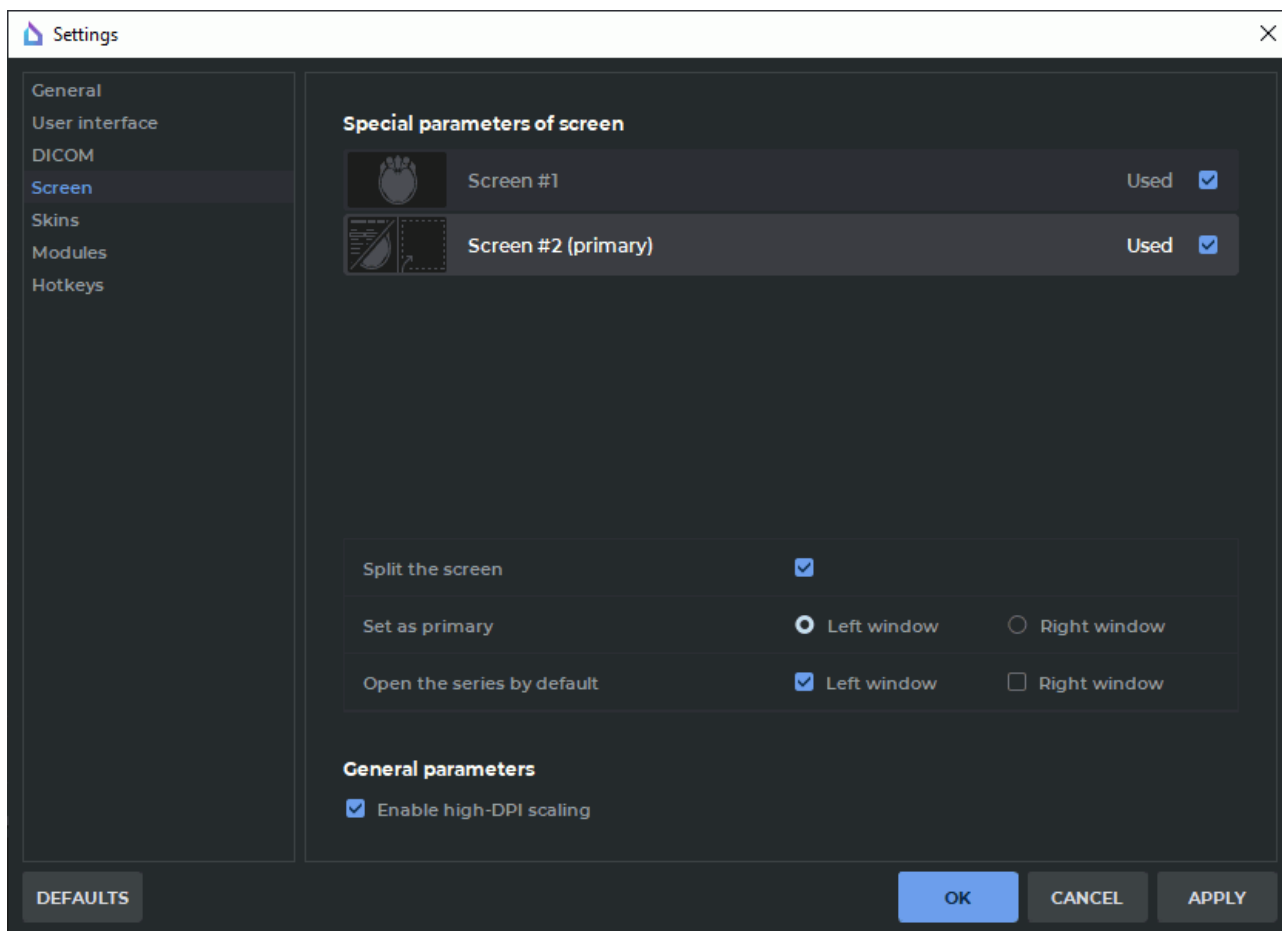



Figure 16.3: Special parameters of the screen

5. Select the left or the right window as the primary by choosing the respective option in the **Set as primary** line. When the DICOM Viewer launched, the tab with the study list appears automatically in the primary window. Only one window may be selected as the primary. In other windows, the tab with the study list may be opened manually from the main menu **File->Study list**.
6. In the **Open the series by default** line, check the boxes for the windows in which you want to open series in the respective tabs (**Image viewer**, **Volume reconstruction**, **MPR reconstruction** etc.) by double-clicking on the thumbnail or by pressing the respective button on the toolbar. The order of opening series in the windows for which the **Open the series by default** box has been checked is determined by the arrangement of the windows (left-to-right or top-down).
7. Click **OK** or **APPLY** to apply the changes or **CANCEL** to cancel the actions. To restore default settings, click the **DEFAULTS** button.
8. In the restart confirmation window, click **YES** to restart or **NO** to cancel restart and continue working.

When the user chooses the **Show as detached window** series arrangement (see Section 1.4), the window is opened in the center of the screen. To fix a detached window, click

the **Fix window**  button in the window header. The window will be added as a tab to the left window of the respective screen.

When the user chooses the **Show fullscreen** series arrangement (see Section 1.4), the window is expanded to full screen. Open series windows may overlap. When the user exits full screen mode, the series window is added as a tab to the respective program window.

### 16.5.3 High resolution monitor support

To automatically scale the interface for high-resolution monitors according to the scale of the operating system, check the **Enable High-DPI scaling** box. The change will take effect the next time you launch DICOM Viewer.

## 16.6 Skins

The following parameters are set up in this section:

- the DICOM Viewer layout (skin):
  - light;
  - dark (used by default).
  
- use the Viewer layout for the Help System.

## 16.7 Modules

In this section you can specify the settings for particular modules (Fig. 16.4).

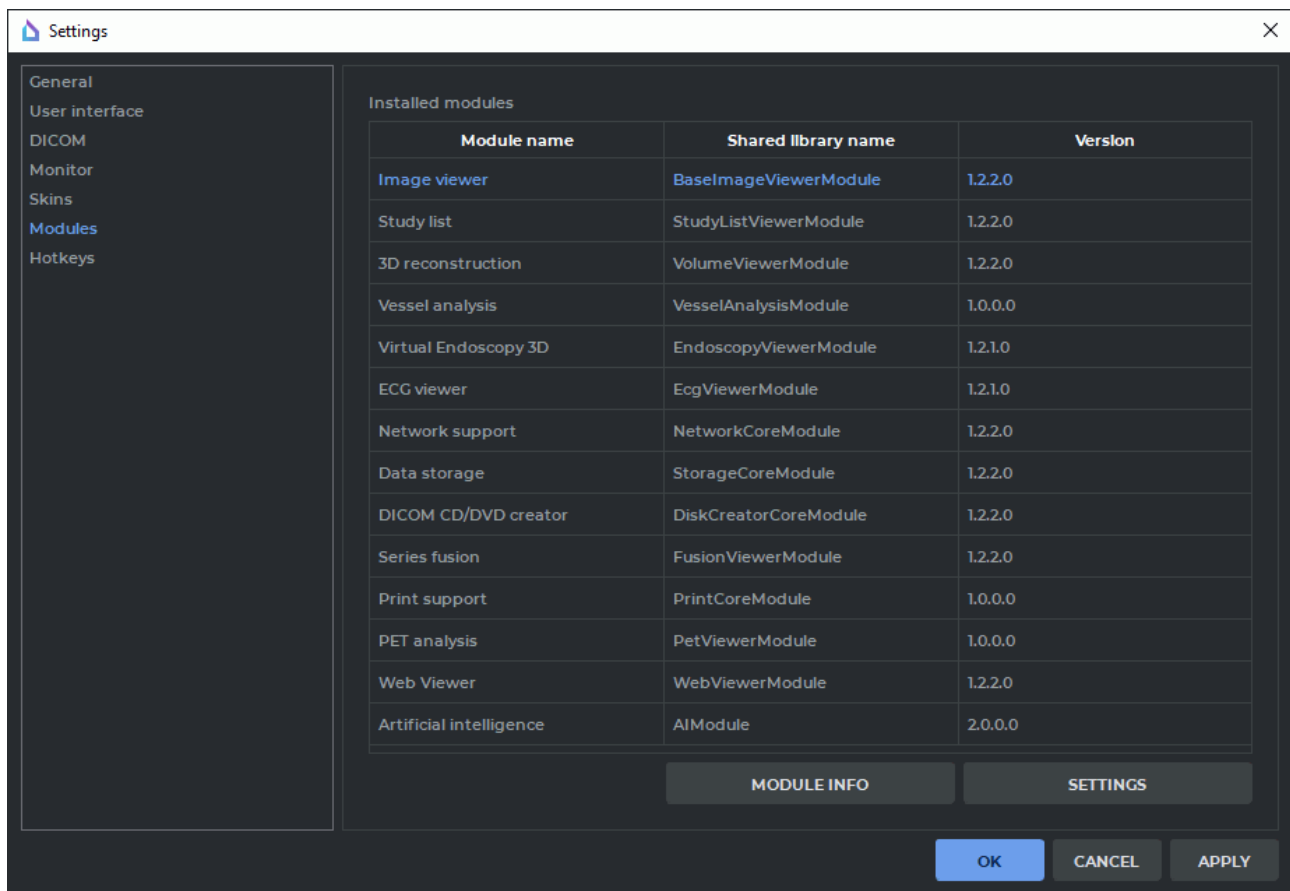

Figure 16.4: Modules

To browse the detailed information about each module, select the module and click the **Module info** button. For some modules, special parameters are set. To do this, select the module from the **Installed modules** list and click the **SETTINGS** button.

### 16.7.1 Set Up Image Viewer Module

Select the **Image Viewer** module from the **Installed modules** and click the **SETTINGS** button. The **Image viewer settings** window contains four tabs with the following parameters:

1. **General** tab. The following parameters are set up:
  - default tool (the one that activates when opening an image). Options:
    - no tool;
    - Adjust W/L;
    - Ruler;
    - Angle;

- ROI rectangle tool;
- ROI ellipse tool;
- ROI polygon tool;
- Sync by point;
- default mode. Options:
  - no mode selected;
  - DSA mode;
- request for confirmation before deleting all annotations and measurements;
- enable/disable the warnings of non-bilinear interpolation;
- show TSE values in annotations;
- enable/disable default synchronization of series image scrolling;
- enable/disable slices scaling and position synchronization for various projections;
- enable/disable display of the series list for the current study on the context menu. The function is enabled by default.

2. **Image arrangement** tab. The following parameters are set up:

- **Confirm series closure on the arrangement changing** option. The option is enabled by default. Switches off/on the display of the dialog box for series deletion confirmation when the user selects a grid with fewer view windows than there are open series in the study. The option is exported to the file saving the current DICOM Viewer settings (see Section 16.9.1);
- default series arrangement;
- splitter priority;
- default image arrangement;
- the number of images scrolled per click;
- **Automatic fill with series** option. The option is disabled by default. It enables/disables automatic study series arrangement in the given grid;
- image sorting method.

These parameters can be set for a specific modality. To add a modality, click the **ADD** button and enter the name of the modality in the dialog that appears. To change the settings for a previously added modality, select it in the **Settings for modality** drop-down list. To delete the selected modality click the **REMOVE** button.

3. **Controllers** tab. Sets up the actions associated with mouse actions.

4. **W/L settings** tab. Sets up the default W/L values. If a value is not specified, the default is 0.

5. **W/L settings** tab. The following parameters are set up:

- option **Use recommended W/L for Series** can be checked/unchecked;
- default W/L for DSA mode can be activated/deactivated;

## 16.7.2 Set Up Study List Module

Select the **StudyList** module from **Installed modules** and click the **Settings** button. The following parameters are set up in the **Study list config** window:

- option **Load local storage automatically** can be checked/unchecked;
- option **Ask to keep in storage autdownloaded series** can be checked/unchecked;
- the period for which the data is loaded can be checked/unchecked;
- font options can be set up;
- option **Allow to edit patient name and description** can be checked/unchecked;
- option **Warn about editing patient name and description** can be checked/unchecked;
- option **Download whole study by double click** can be checked/unchecked;
- option **Fixed thumbnail height** can be checked/unchecked.

## 16.7.3 Set Up 3D Reconstruction Module

Select the **3D Reconstruction** module from **Installed modules** and click the **Settings** button. The window contains two tabs with the following parameters:

### 1. **Render** tab.

- Sets up the render device. Options:
  - Auto;
  - CPU (using the software facilities);
  - OpenCL support;
  - CUDA support.
  - Metal support. Supported on macOS version 10.15 and greater.



The options available may vary depending on the configuration and equipment settings.



**Rendering devices based on CUDA are not supported by 32-bit operating systems and macOS.**

- Customize the cache memory limits for the selected imaging device.

By default, the imaging device is selected by the program automatically and is shown on the drop-down list as the **Auto** option. The cache memory limits that can be changed are displayed for this device. For each device on the drop-down list, the amount of memory available for caching is displayed.

The fields for setting cache memory limits are provided with a restore recommended value button . The restore recommended value button is displayed when the limit value provided is different from the recommended value. To restore the recommended value of a cache memory limit, click the  button in the respective field.





**You cannot customize the cache memory limits for the CPU (software). The cache memory limits for this device are calculated on the basis of the values provided in the General tab (see Section 16.1).**

2. **Segmentation** tab. The following parameters are set up:

- sets the default structure opacity;
- option **Invert edit mask on MPR** can be checked/unchecked;
- option **Confirm on the structure removing** activates the confirmation dialog box when deleting a structure. The option is enabled by default;
- option **Collapse new structure on creation** determines whether the newly added structure element on the segmentation panel list shall be collapsed or not. If the option is enabled, the added structure is collapsed, if the option is disabled, it is not. The function is enabled by default.

A new structure element is added to the list on the segmentation panel when the following actions are performed:

- a new structure is created;
- an existing structure or structure mask is copied;
- a surface is exported to a new structure;
- a series containing segmented structures or 3D models is opened;
- data from an *.spj* or *.autospj* are loaded;
- data from DICOM RT are imported.

3. **Project** tab.

- Sets up the function of saving projects:
  - Enables/disables the **Save DICOM data of series** option;
  - Enables/disables the **Enable autosaving** option;
  - Sets the autosave frequency on the **Timeout** dropdown list.
- Selects the mode in which the saved project is to be opened: **3D**, **MPR** or **Both**.

4. **Reconstruction** tab.

- option **Warn about varied slices distance** can be checked/unchecked;
- option **Warn about reducing quality because of reslicing** can be checked/unchecked;
- sets up reconstruction by series with varying distances between slices. Options:
  - Non uniform slice interpolation;
  - Max uniform distance slice range.

5. **UI** tab. The following parameters are set up:

- Saving MPR view sizes. To change this parameter, checks/unchecks option **Save MPR view sizes**. By default, it is unchecked;
- MPR plane line thickness;
- MPR plane line colors;

- Disabling the display of the standard space orientation panel in the **Volume reconstruction** and **3D view** windows of the **MPR reconstruction** tab. By default, it is enabled. To disable the display of the panel, untick the **Show a panel of standard projections in a 3D view** box. The changed panel display settings are not applied to the tabs and windows that had been opened before the changes were introduced;
  - selects in the list the action to be performed after CLUT is change if W/L is changed;
  - Request for confirmation before deleting all measurements;
  - Split brush cut and brash restore tools.
6. **3D controllers** tab. Sets up the actions associated with mouse actions in the Volume Reconstruction window.
  7. **MPR controllers** tab. Sets up the actions associated with mouse actions in the MPR, Planning of Pedicle Screw Installation and Vessel Analysis windows.

#### 16.7.4 Set Up Vessel Analysis Module

Select the **Vessel analysis** module from **Modules** and click the **Settings** button. The window contains tab with the following parameters:

1. UI tab. The following parameters are set up:
  - Enabling saving the window size in the **Vessel analysis** tab. By default, it is disabled.
  - Disabling the display of the standard space orientation panel in the **3D view** window of the **Vessel analysis** and **Coronary artery analysis** tab. By default, it is enabled. To disable the display of the panel, untick the **Show a panel of standard projections in a 3D view** box. The changed panel display settings are not applied to the tabs and windows that had been opened before the changes were introduced.
  - Disabling the option **Request a non-enhanced series to remove bones on window opening**. By default, it is enabled.

#### 16.7.5 Set Up Network Support Module

Select the **Network support** module from **Installed modules** and click the **SETTINGS** button. You can specify the maximum count of connections to a PACS Server.

#### 16.7.6 Set Up Local Storage Module

Select the **Data storage** module from **Installed modules** and click the **SETTINGS** button. The window contains the following parameters:

1. the **Automatic local storage cleaning** option can be checked/unchecked;
2. cleaning interval can be set.

### 16.7.7 Set Up «DICOM CD/DVD Creator»

Select the **DICOM CD/DVD creator** module from the **Installed modules** and click the **SETTINGS** button. You can specify the following parameters:

- the «**Add selected studies at opening DICOM CD/DVD creator**» option can be checked/unchecked;
- the «**Add DICOMDIR file to created DICOM CD/DVD image before writing data**» option can be checked/unchecked;
- the «**Enable image buffering**» option can be checked/unchecked.

### 16.7.8 Set Up PET Analysis Module

Select the **PET Analysis** module from **Installed modules** and click the **SETTINGS** button. You can specify the following parameters:

The **Common** tab:

- **Enable SUV mode automatically**;
- **MIP layer CLUT** by default;
- window upper limit. The **Max SUV value** and **Max window percent** items are available;
- **First layer modality** by default for the PET+CT window;
- **PET layer CLUT** by default for the PET+CT window;
- **CT layer opacity (%)** by default for the PET+CT window;
- **PET layer opacity (%)** by default for the PET+CT window;
- option **Ask before deleting all annotations and measurements** can be checked/unchecked.

In the **Controllers MIP** tab you can associate tools with the mouse wheel and move operations for the MIP window, in the **Controllers 2D** tab you can do it for the CT and PET windows.

The settings are applied the next time you open the PET Analysis window.

To restore default values, click the **DEFAULTS** button.

## 16.8 Set Up Hotkeys Module

In this section, you can specify hotkeys to perform different actions. To set up hotkeys:

1. Select the **Options** menu and the **Settings...** item.
2. Open the **Hotkeys** section. The window similar to the one shown in Fig. 16.5 will pop up.
3. Select the target action in the table. If necessary, enter action name or hotkey in the **Filter** field to filter the action list. The hotkeys specified for the selected action are displayed in the **Key sequence** column.

4. To modify or set hotkeys:

- change the value in the **Key sequence** field or
- click the **RECORD** button; next, press the key sequence you wish to assign on the keyboard and to finish, click the **Stop recording** button.

The entered value will be immediately displayed in the **Key sequence** column of the table.

5. To delete hotkeys, erase the value in the **Key sequence** field.

6. If the entered hotkeys are already used, a warning similar to the one shown in Fig. 16.6 will be displayed, and the value in the **Key sequence** column will be written in red. To see which action corresponds to this hotkeys, click **Show**. Do not set the same hotkeys for the actions performed in one window. If the entered value cannot be set, a warning similar to the one shown in Fig. 16.7 will be displayed.

7. To restore the original value of the hotkeys for the selected action, click the **RESET** button.

8. To restore the original values of the hotkeys for all actions, click the **RESET ALL** button.

9. Click **OK** or **APPLY** to apply the changes or **CANCEL** to cancel the actions.

10. In the restart confirmation window, click **YES** to restart or **NO** to cancel the restart and continue working.

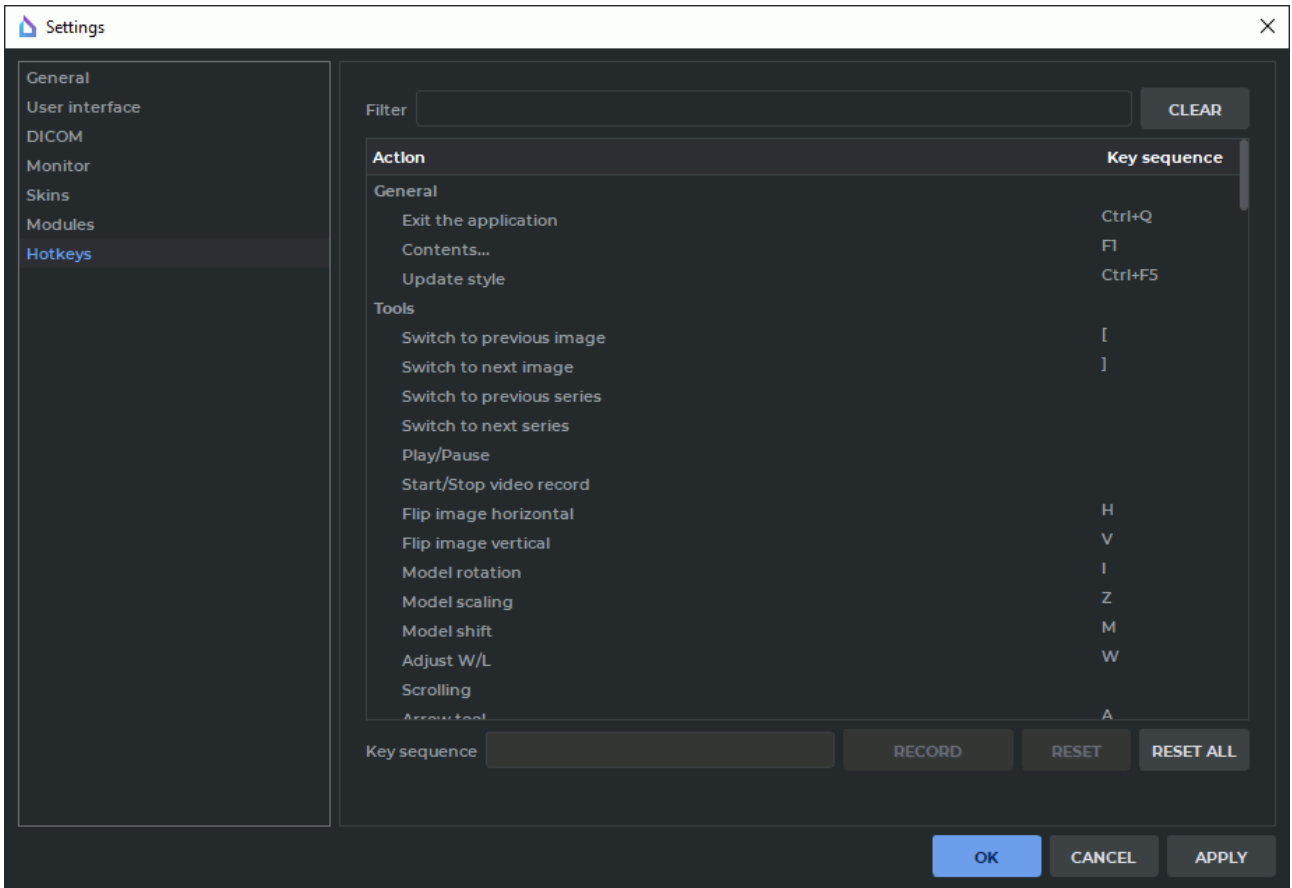

Figure 16.5: Hotkeys

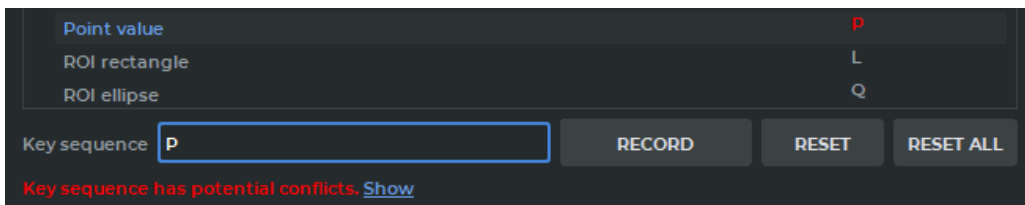

Figure 16.6: Warning about key sequence potential conflict

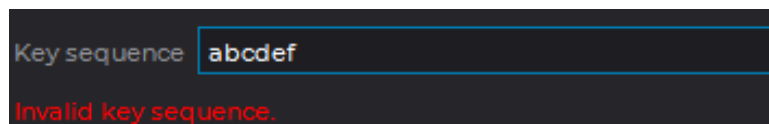

Figure 16.7: Warning about invalid key sequence

The types of hotkeys are described in the following table:

Hotkey type	Designation
Single key: any key of the alphanumeric keyboard or a functional key	Single key, e.g.: « <b>A</b> » or « <b>F5</b> »
Group of keys: two keys should be pressed simultaneously. The first key is <b>Ctrl</b> , <b>Alt</b> or <b>Shift</b> , the second one is any key of the alphanumeric keyboard or a functional key	Two single keys coupled by «+», e.g.: « <b>Ctrl+S</b> » or « <b>Shift+F5</b> »
A sequence of several keys of the alphanumeric keyboard or functional keys: keys should be pressed one by one	Single keys or groups of keys, separated by comma, e.g.: « <b>A,B,C</b> » or « <b>Ctrl+F1,Ctrl+F2</b> »

## 16.9 Import and Export Settings

### 16.9.1 Export Settings

The export functionality allows you to save the current DICOM Viewer settings in a file. To export settings:

1. Select the **Options** menu and the **Export settings** item. The save file dialog box will pop up.
2. Select the location to save the settings file to and enter the file name.
3. Click **Save** to save the settings file or **Cancel** to cancel the actions.

### 16.9.2 Import Settings

The import functionality allows you to apply the settings specified earlier and saved in a file. To import settings:

1. Select the **Options** menu and the **Import settings** item. The DICOM Viewer will request confirmation for this action because all the current settings will be lost after the import. Click **Yes** to continue or **No** to cancel the import.
2. If you click **Yes**, the settings file selection dialog box will pop up. Select the needed file.
3. To import the settings, click **Open**. The DICOM Viewer will be restarted, and the settings will be applied. To cancel the import, click **Cancel**.

### 16.9.3 Import CLUTs

The CLUTs import option provides an opportunity to use customized CLUTs (e.g. CLUTs created by other users or CLUTs from previous DICOM Viewer versions).

CLUTs are saved in *vt\_config.xml* file.

To import CLUTs, copy the *vt\_config.xml* file to the **Configs** folder. The location of the **Configs** folder depends on the operating system (see Section **Service files**).

For example, a user named *Smith* working on *Windows* will find the CLUTs for *Inobitec DICOM Viewer Pro 2.7.0* in the following folder:

*C:\Users\Smith\AppData\Local\Inobitec\Inobitec DICOM Viewer Professional Edition 2.7.0\Configs*

# Chapter 17

## DICOM Tag Viewing

### 17.1 DICOM Tags. General Information

A DICOM file presents data as a sequence of elements containing information about the image (graph etc.), where the last element has the image (graph etc.) itself. Each element comprises several parts, including:

- **Tag** — a unique element identifier comprised of a pair of values represented in the hexadecimal number system and determining the group number and the element number
- **Data type** — a line showing the data type abbreviation (two symbols)
- **Data field length;**
- **Data** — the information comprised in the element, including the image (graph etc.) itself

If the **Data** field contains information that cannot be represented in the form of a text (e.g. an image or graph), then the respective column will read: **Binary content. Hidden.**

If the tag is standard, its name will be shown. If the tag is reserved by a certain modality manufacturer or there is an error in its name, then the field will read: **Unknown Tag & Data.** To learn about the data contained in this tag, you will need to study the documents for the modality used in the study. The **7fe0,0010 (PixelData)** tag contains an image, a graph or some other visual data.

Examples of elements:

Element name	Tag	Type	Length	Data
StudyDate	0008,0020	DA	8	20130107
StudyInstanceUID	0020,000d	UI	56	1.3.12.2.1107.5.2.6.24186. 30000013011710501018700000060
Modality	0008,0060	CS	2	MR



Element name	Tag	Type	Length	Data
Unknown Tag & Data	0051,1009	LO	4	1.0
PixelData	7fe0,0010	OW	2	Binary content. Hidden.

## 17.2 DICOM Tag Viewer Window

There are four ways to view DICOM tags:

1. Select a series thumbnail on the series panel and click the **Show image tags** </> button on the toolbar (see Section 1.4).
2. Right-click on a series thumbnail to call up the context menu and select the **Show image tags** option.
3. Select the **Show image tags** option from the **View** tab of the main menu (see Section 1.1).
4. Open a study series in the **Image viewer** tab (see Section 2.30), right-click to call up the context menu and select the **Show image tags** option.



**ECG modality series (see Chapter 11) and series containing protocols (see Chapter 18) are opened in the respective tabs. PDF documents are opened in third-party software installed in the user's OS. Series that do not conform to the DICOM standard or series for which there are no special tabs to view are opened in the DICOM tag viewer tab.**

The **DICOM Tag Viewer** window is shown in Fig. 17.1.

Name	Tag	VR	VM	Length	Text
xml					version="1.0" encoding="ISO-8859-1"
file-format					
meta-header (xfer: Little Endian Explicit)					
FileMetaInformationGroupLength	0002,0000	UL	1	4	222
FileMetaInformationVersion	0002,0001	OB	1	2	\x00\x01
MediaStorageSOPClassUID	0002,0002	UI	1	26	1.2.840.10008.5.1.4.1.1.2
MediaStorageSOPInstanceUID	0002,0003	UI	1	56	1.2.276.0.7230010.3.1.4.1070191241.18260.1655464974.1233
TransferSyntaxUID	0002,0010	UI	1	22	1.2.840.10008.1.2.4.57
ImplementationClassUID	0002,0012	UI	1	28	1.2.276.0.7230010.3.0.3.6.6
ImplementationVersionName	0002,0013	SH	1	16	OFFIS_DCMTK_356
SourceApplicationEntityTitle	0002,0016	AE	1	12	MCHERNOVAS3
data-set (xfer: JPEG Lossless, Non-hierarchical, Process 14)					
GenericGroupLength	0008,0000	UL	1	4	1006
SpecificCharacterSet	0008,0005	CS	1	10	ISO_IR 100
ImageType	0008,0008	CS	3	22	ORIGINALPRIMARYAXIAL
InstanceCreationDate	0008,0012	DA	1	8	20210921
InstanceCreationTime	0008,0013	TM	1	6	122957
SOPClassUID	0008,0016	UI	1	26	1.2.840.10008.5.1.4.1.1.2
SOPInstanceUID	0008,0018	UI	1	56	1.2.276.0.7230010.3.1.4.1070191241.18260.1655464974.1233
StudyDate	0008,0020	DA	0	0	
SeriesDate	0008,0021	DA	1	8	20210921
AcquisitionDate	0008,0022	DA	1	8	20210921
ContentDate	0008,0023	DA	1	8	20210921
StudyTime	0008,0030	TM	1	6	122708
SeriesTime	0008,0031	TM	1	6	122834
AcquisitionTime	0008,0032	TM	1	14	122847094707
ContentTime	0008,0033	TM	1	6	122957
AccessionNumber	0008,0050	SH	1	6	780427
Modality	0008,0060	CS	1	2	CT
Manufacturer	0008,0070	LO	1	18	GE MEDICAL SYSTEMS

Figure 17.1: DICOM Tag Viewer window

## 17.2.1 Toolbar

The toolbar is placed in the upper part of the window (Fig. 17.2).

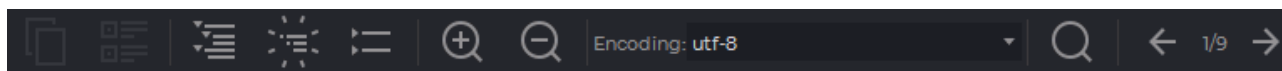













Figure 17.2: Toolbar

Tools:

	The <b>Copy</b> button is used for copying the selected data to the clipboard.
	The <b>Detail</b> button is used for showing the contents of the element in a separate window.
	The <b>Expand all</b> button shows the tag tree.
	The <b>Optimal view</b> button shows only two levels of the tag tree.
	The <b>Collapse all</b> button is used to collapse the tag tree.
	The <b>Zoom in</b> button is used to enlarge the text size.
	The <b>Zoom out</b> button is used to shrink the text size.
	The <b>Encoding</b> drop-down menu allows for the selection of the character set used for displaying data. By default, the character set provided for in the DICOM file is used.
	The <b>Search</b> button opens/closes the search bar at the bottom of the window.
	The <b>Switch to previous image</b> button shows the DICOM tags for the previous image in the series.
	The image indicator shows the current image number and the total number of images in the series. The number is assigned to the image by the modality, and it may be different from the sequence number of the image shown in the <b>Image Viewer</b> window.
	The <b>Switch to next image</b> button shows the DICOM tags for the next image in the series.

## 17.2.2 Tag Tree

The tag tree is placed under the toolbar. If several tags belong to the same group, the group is unfolded and the tags are shown. Groups can be nested, one inside another. To unfold a group, click + on its left; to collapse a group, click -. To unfold all the groups, click the **Show All** button on the toolbar; to collapse all the groups, click **Collapse All**; to unfold only second level groups, click the **Best View** button.

Tags cannot be edited. The data from the DICOM tag viewer tab can be copied to the clipboard and then inserted in the report editor (see Chapter 18) or in any text editor. To copy the value from the element field, select it with the left mouse button and click **Copy** on the toolbar, or else choose **Copy** on the context menu.

## 17.2.3 Search

To open the search bar, click the **Search** button on the toolbar. The search bar will be displayed at the bottom of the window. To close the search bar, click the cross on the right or the **Search** button.

You can perform search by any data contained in the element. To perform search, enter the text you need to find in the **Search** field. The elements with fully or partially matching values will be highlighted in green; the first element found will be highlighted in orange. If no matches are found, the text entered will turn red. The number of the element chosen and the total quantity of the elements found is displayed on the right. To go to the next element found, click the **Next** button; to go to the previous element, click the **Previous** button. To perform case sensitive search, check the **Match Case** box. To highlight all the values found, check the **Highlight All** box (it is checked by default).

## 17.3 Anonymize studies and series

Anonymization is possible only for the studies in the Local Storage or for those that are opened from a folder or from a CD.

The DICOM Viewer 2.15 provides for an extended list of tags anonymized by default. If the list of tags was edited by a user of DICOM Viewer 2.14 or inferior, the new tags will not be added to the list of tags anonymized by default. The complete list of tags anonymized by default will be restored after the user click the **DEFAULTS** button in the **Anonymization** dialog box (Fig. 17.3) and performs the anonymization procedure. If required, you can edit the list of tags anonymized by default (the procedure is described below).

The data stored in the following tags will be replaced with **Anonymous** value or deleted:

- **(0010,0010) PatientName;**
- **(0010,0030) PatientBirthDate;**
- **(0010,0040) PatientSex;**
- **(0010,1010) PatientAge;**
- **(0008,0080) InstitutionName** (institution or organization to which the identified individual is responsible or accountable);

- **(0008,0081) InstitutionAddress** (mailing address of the institution or organization to which the identified individual is responsible or accountable);
- **(0008,0090) ReferringPhysicianName** (name of the patient's referring physician);
- **(0008,1050) PerformingPhysicianName** (name of the physician(s) administering the Series);
- **(0008,1070) OperatorsName** (name(s) of the operator(s) supporting the Series);
- **(0008, 1010) StationName**;
- **(0018,1030) ProtocolName**;
- **(0008,1090) ManufacturerModelName**.



The **(0010,0020) PatientID** (patient's identifier) tag value will be replaced with a random alphanumeric value.

To anonymize values stored in other tags, you must add these tags to the list (see below).



**For the (0008,0018) SOPInstanceUID and (0020,000e) SeriesInstanceUID tags, new values are generated by default when series are anonymized. If a study is anonymized, the value of the tag (0020,000d) StudyInstanceUID is additionally changed.**

To anonymize studies:

1. Select one or more studies in the Local Storage, a local folder or a CD.
2. Select the **Studies** menu and **Create anonymized copies of the selected studies...** The **Anonymization** dialog box (Fig. 17.3) pops up.
3. To add a tag to anonymize, type the group number to the **Group** field and type the element number to the **Element** field and click the  button (Fig. 17.3).
4. To delete a tag to anonymize, click the  button.
5. By default, the data stored in tags is replaced by «Anonymous». To change the text value of the tag, left-click on the respective field and enter the new value.



**Warning! The format of the input data must comply with the DICOM standard.**

6. To disable tag anonymization without deleting the tag from the list, uncheck the box against the chosen tag. By default, the boxes for all the tags added to the anonymization list are checked.
7. To restore the default tag list, click the **DEFAULTS** button.
8. To Anonymize, click **OK**, to cancel click **CANCEL**.

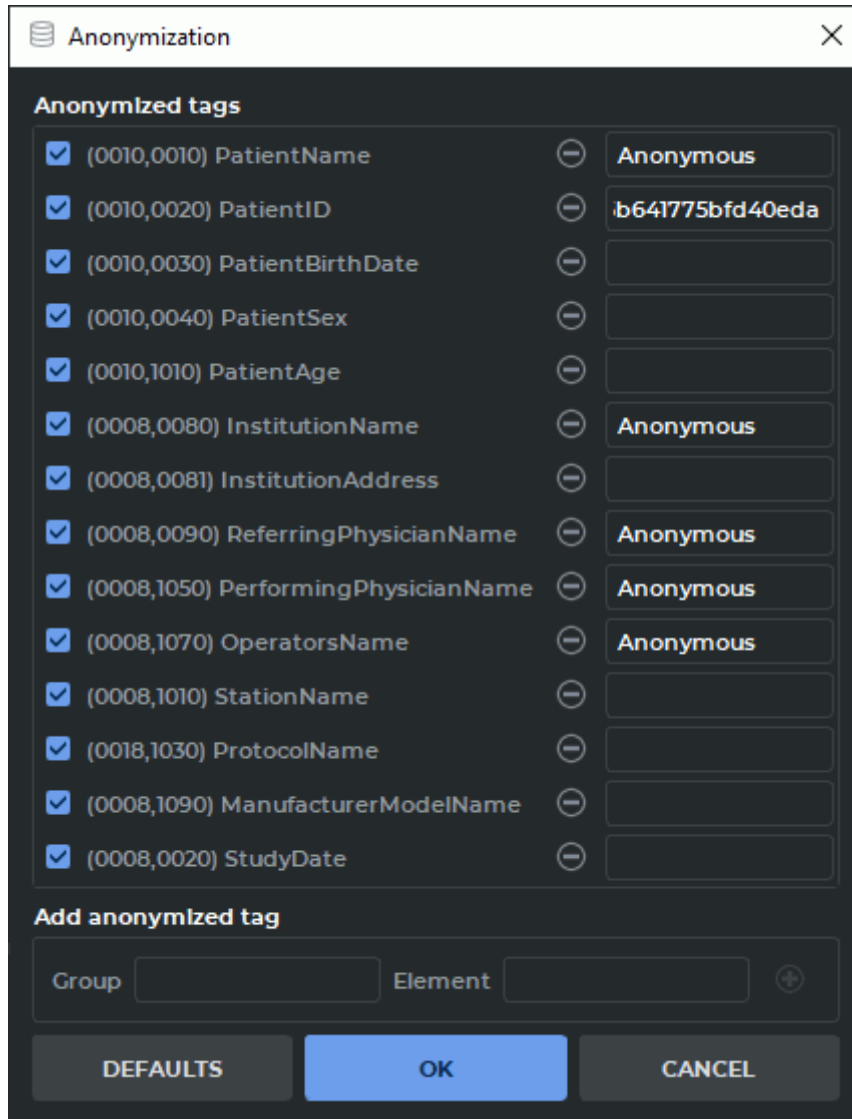

Figure 17.3: Dialogue of anonymization

If other tags contain data that matches the data contained in anonymized tags, the warning appears (Fig. 17.4).

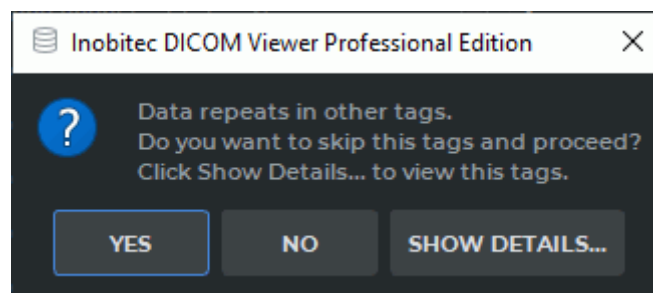



Figure 17.4: Match data warning

To view the tags containing the same data as the anonymized tags, click **SHOW DETAILS...** To save the study without changing the tag data, click **YES**. To change the tag values, click **NO** and add the selected tags to the anonymization list.

The tags with the data that matches the data contained in the anonymized tags are automatically added to the **Anonymization** box (Figure 17.3). By default, the added tags are ticked. To anonymize the tags, click **OK**; to cancel, click **CANCEL**.

The selected studies will be anonymized and saved to the Local Storage with the patient's name Anonymous.

To anonymize the selected series:

1. Select study in the Local Storage, a local folder or a CD.
2. Select the series that you want to Anonymize. For details on how to work with series, see Section 1.10.
3. Select the **Studies** menu and **Create anonymized copy of series...**
4. To add a tag to anonymize, type the group number to the **Group** field and type the element number to the **Element** field and click the  button (Fig. 17.3).
5. To delete a tag to anonymize, click the  button.
6. By default, the data stored in tags is replaced by «Anonymous». To change the text value of the tag, left-click on the respective field and enter the new value.



**Warning! The format of the input data must comply with the DICOM standard.**

7. To disable tag anonymization without deleting the tag from the list, uncheck the box against the chosen tag. By default, the boxes for all the tags added to the anonymization list are checked.
8. To restore the default tag list, click the **DEFAULTS** button.
9. To Anonymize, click **OK**, to cancel click **CANCEL**.



**For the (0008,0018) SOPInstanceUID and (0020,000e) SeriesInstanceUID tags, new values are generated by default when series are anonymized.**

The selected series will be anonymized, saved to the Local Storage and marked **anonymized**.



**Make sure that no personal data are retained in customized tags and that standard tags only have anonymized data.**

---

# Chapter 18

## Report Editor

---

Functionality is available in the **Pro** edition

---

The DICOM Viewer report editor provides an opportunity to create, edit and save medical documents, such as reports, opinions, statements etc. The documents created in Inobitec DICOM Viewer may be opened for reading and editing in the Inobitec Web DICOM Viewer and vice versa.

The DICOM Viewer report editor allows the user to format text, create and edit tables, insert images from the clipboard.

The created user reports are saved as special SR series in the local storage and may be exported as PDF files or DICOM DOC series.



### 18.1 Editor Window

---

Functionality is available in the **Pro** edition

---

The editor window is shown in Fig. 18.1. The windows and tools for editing text in the report editor and template editor are the same.

The DICOM Viewer provides the user an opportunity to change the borders of the editor window. For that purpose, mouse over a border so that the cursor takes the shape of  or . Then move the border while holding the left mouse button. The new window size will be saved in the program and restored when you launch the editor again.

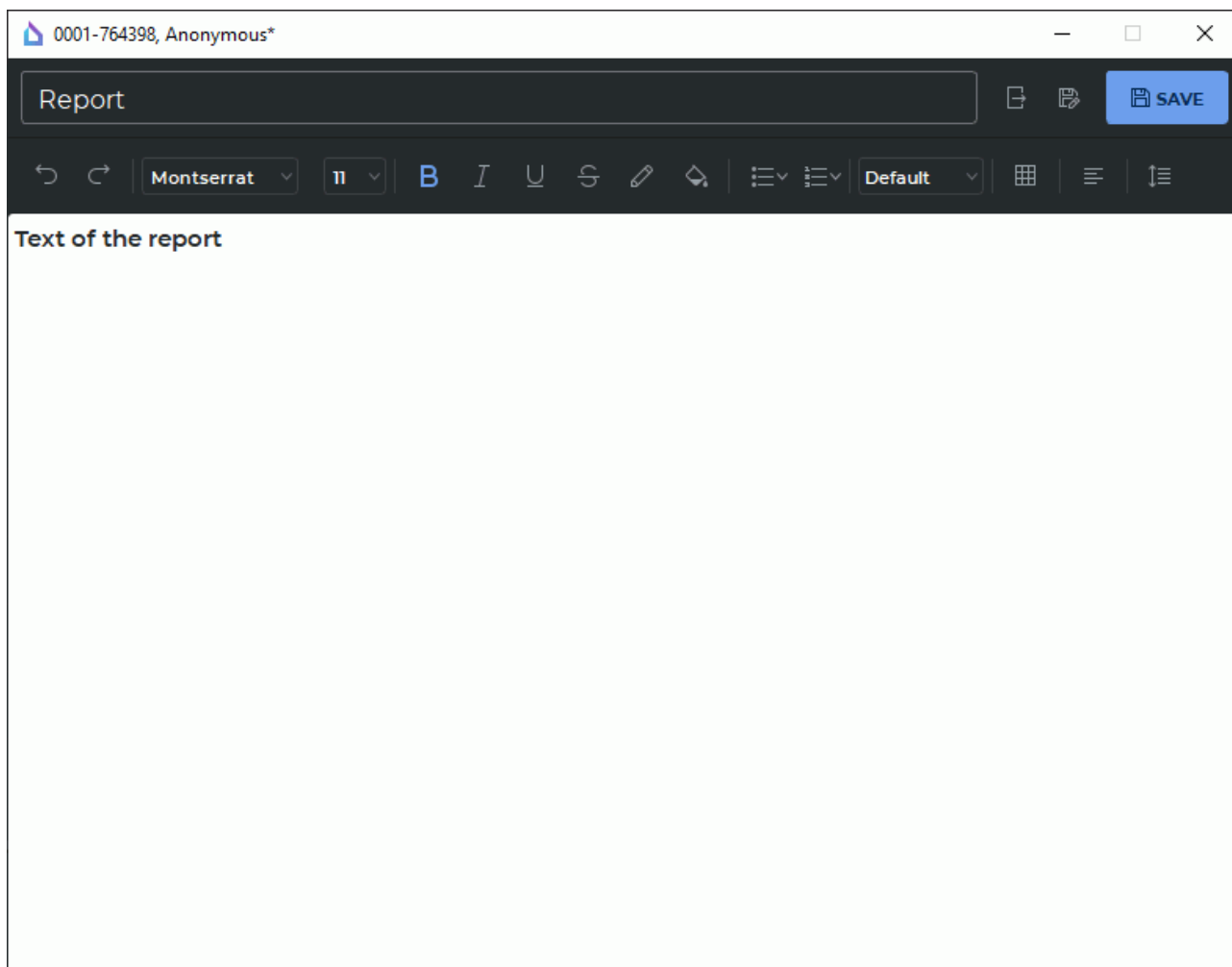

Figure 18.1: Editor window

## 18.1.1 Toolbar

---

Functionality is available in the **Pro** edition

---

The toolbar is placed in the upper part of the editor window (Fig. 18.1).

In the upper left-hand corner of the toolbar, you can see a field where the user enters the name of the document.





The name must not contain:

- such symbols as: :, >, <, ?, \*, |, ", \, /, +, %, !, @;
- a space in the beginning of the name;
- a space or a dot at the end of the name.

If this rule is ignored, an error message will pop up when you try to save the template or export a report in a PDF file.



In the upper part of the editor window you will see the following buttons:

	The <b>Export</b> button in the report editor window opens the menu for exporting the report in a PDF file or a DICOM DOC series (see Section 18.2.4). The same button in the template editor window opens the dialog box for exporting the report template in a file (see Section 18.3.3).
	The <b>Save as</b> button in the report editor window creates a new SR series with report (see Section 18.2.3). The same button in the template editor window creates a new template (see Section 18.3.5).
	The <b>SAVE</b> button in the report editor window saves the report in the current study as a new series. When you click the same button again, the changes are saved in the current series (see Section 18.2.3). The <b>SAVE</b> button in the template editor window saves the changes in the current template (see Section 18.3.5).
	The <b>Undo</b> button cancels the last change in the report/template editor.
	The <b>Redo</b> button repeats the last cancelled action in the report/template editor.

## 18.1.2 Text Editing Tools

---





Functionality is available in the **Pro** edition

---

The editor toolbar contains tools for editing text. Text editing tools in the report and template editor have the same functions.

- drop-down list of font families. It is a complete list of the font families available in the program;
- drop-down list of font sizes. It is a list of the most popular font sizes. It also provides an opportunity to enter the required font size manually;
- buttons for changing the display style of symbols and text, such as:
  - **Bold** **B** ;
  - **Italic** *I* ;
  - **Underline** U ;
  - **Strikethrough** ~~S~~ .

The style is changed for the highlighted text or for the text being typed.

- the **Font color**  button is used for changing the font color. The changes are applied to the highlighted symbol or part of the text;
- the **Highlight color**  button is used for changing the background color. The changes are applied to the highlighted symbol or part of the text;
- the **Bulleted list**  button creates a bulleted list. The following types of bullets are available:
  - **Bulleted list (filled circle)** used by default;
  - **Bulleted list (empty circle);**
  - **Bulleted list (filled square).**
- the **Ordered list**  button creates a numbered list. The following numbering styles are available:
  - **Ordered list (numbers)** used by default;
  - **Ordered list (lower roman);**
  - **Ordered list (upper roman);**
  - **Ordered list (lower case);**
  - **Ordered list (upper case).**
- drop-down list of preset font styles (font size and style). It provides for the following options:
  - **Default** (font size: 11, style: -);
  - **Heading 1** (font size: 22, style: bold);
  - **Heading 2** (font size: 17, style: bold);
  - **Heading 3** (font size: 13, style: bold);
  - **Heading 4** (font size: 11, style: bold);
  - **Heading 5** (font size: 9, style: bold);
  - **Heading 6** (font size: 8, style: bold).
- the **Insert table**  button is used for adding tables to the document. When the user presses the button, a dialog box for setting table parameters (Fig. 18.2) pops up.

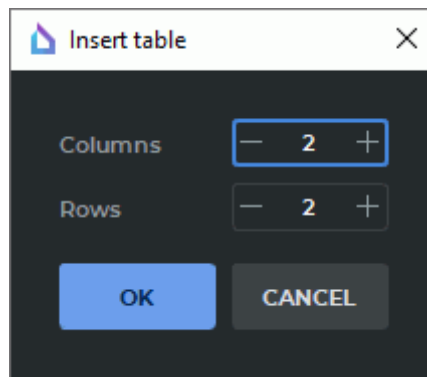







Figure 18.2: Dialog box for setting parameters of a table

If the cursor is placed in the beginning of a line, the table will be inserted in the same line. If the cursor occupies a different position in the line, the table will be inserted in the next line. By default, all the columns of a table have the same width. To change the width of the column, move one of its borders to the right or to the left. The position of the left border of the first column cannot be changed. The height of the table rows is changed automatically depending on the content of the cells.

The commands for modifying table cells can be found on the context menu. The following options are available:

- **merging cells.** Select the cells you want to merge. For that purpose, place the cursor in the first cell and drag it through the cells to be merged while holding the left mouse button. Click the right mouse button and select the **Merge cells** option on the context menu;
- **splitting cells.** Place the cursor in a cell you want to split or select a range of cells. Click the right mouse button and select the **Split cells** option on the context menu. You can only use this command to split merged cells;
- **inserting rows.** Place the cursor in a cell next to which you want to add a row or select several rows. Click the right mouse button and select either the **Insert rows above** or the **Insert rows below** option on the context menu. If only one cell was selected, one row will be added. If several rows were selected, the same number of rows will be added to the table;
- **inserting columns.** Place the cursor in a cell next to which you want to add a column or select several columns. Click the right mouse button and select either the **Insert columns to the left** or the **Insert columns to the right** option on the context menu. If only one cell was selected, one column will be added. If several columns were selected, the same number of columns will be added to the table;
- **deleting rows.** Place the cursor in a cell of the row you want to delete or select several rows. Click the right mouse button and select the **Remove rows** option on the context menu. If only one cell was selected, one row will be deleted. If several rows were selected, all these rows will be deleted;
- **deleting columns.** Place the cursor in a cell of the column you want to delete or select several columns. Click the right mouse button and select the **Remove**

- **columns** option on the context menu. If only one cell was selected, the column with this cell will be deleted. If several columns were selected, all these columns will be deleted;
  - **deleting a table**. Place the cursor in a cell of the table. Click the right mouse button and select the **Remove table** option on the context menu.
- the **Align** button is used for aligning text of the selected paragraph. The following options are available:
  - **Left align**  used by default;
  - **Centre align**  ;
  - **Right align**  ;
  - **Justify**  .
- the **Line spacing**  button is used for setting the intervals between the lines of the current paragraph, as well as the intervals between paragraphs. If you click the  button, a dialog box will pop up (see Fig. 18.3).

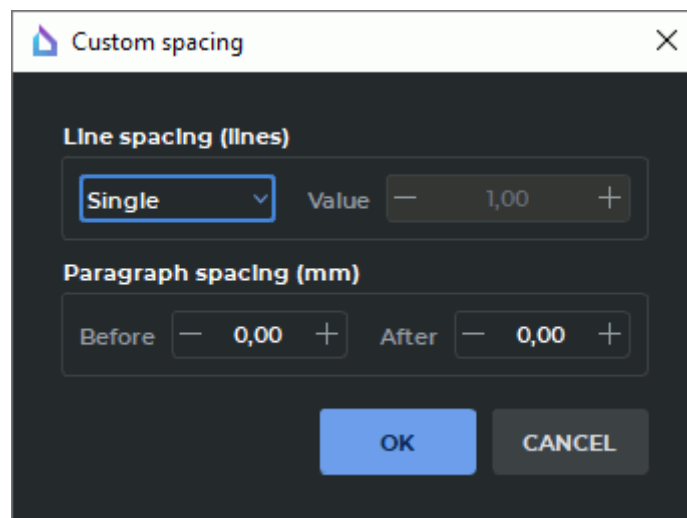

Figure 18.3: Dialog box for setting line spacing

The line spacing drop-down list provides for the following options:

- **Single** used by default;
- **Proportional**. This interval is calculated as the font height multiplied by the number provided in the **Value** field. The range of values is from 1.0 to 10.0;
- **Fixed**. The exact line height value is provided in millimeters. The range of values is from 0.5 to 120.0;

- **Minimum.** The minimum line height value is provided in millimeters. The range of values is from 0.5 to 120.0;
- **Leading.** An additional interval value is provided in millimeters. The range of values is from 0.5 to 120.0.

In the **Paragraph spacing (mm)** section the user sets the intervals before and after the current paragraph. The range of values is from 0.0 to 120.0.

## 18.2 Working with Reports

---

Functionality is available in the **Pro** edition

---

The DICOM Viewer allows the user to create empty reports (see Section 18.2.1) and reports based on templates (see Section 18.2.2).

### 18.2.1 Creating an Empty Report

---

Functionality is available in the **Pro** edition

---

There are three ways to create a new report in the study list tab:

1. Select a study on the study panel. Select a study series on the series panel. Click the arrow on the right-hand side of the **Report**  button on the toolbar and select the **Empty report** option on the drop-down menu (see Fig. 18.4).
2. Right-click on the series thumbnail and select **Report->Empty report** on the context menu.
3. Select a series thumbnail on the series panel. On the main menu, select **View->Report->Empty report**.

To create a new report in the **Image viewer** tab, select a series on the series panel. Then click the arrow on the right-hand side of the **Report**  button on the toolbar and select the **Empty report** option on the drop-down menu (see Fig. 18.4).

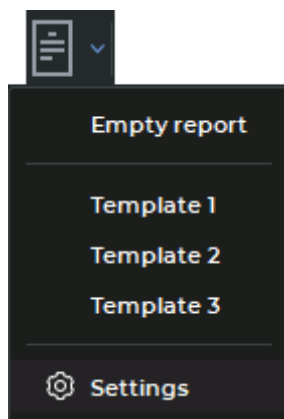

Figure 18.4: Drop-down menu of the **Report** button

An empty report named **Report** is created. The heading for the report editor window is generated with the  $\langle Patient ID \rangle, \langle Patient Name \rangle$  values for the current study. You will find the information on creating reports on the basis of templates in Section 18.2.2.

## 18.2.2 Creating a Report Based on a Template

---

Functionality is available in the **Pro** edition

---

To create a report on the basis of a template, select a series thumbnail and click the arrow on the right-hand side of the **Report**  button on the toolbar. On the drop-down menu that pops up (Fig. 18.4), select the required template from the list. An editor window for reports based on templates will be displayed on the screen. For details on templates (their creation, editing, saving, and export) see Section 18.3.

To select a template that will be used by default when a report is created, click the arrow on the right-hand side of the **Report**  button on the toolbar. On the drop-down menu, select **Settings**.

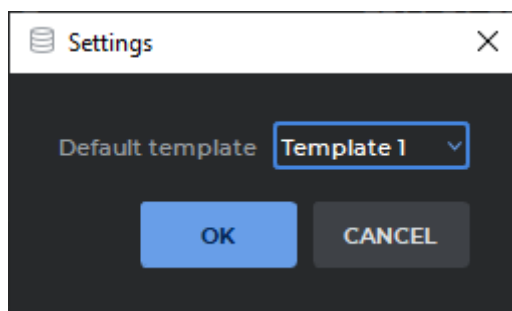

Figure 18.5: Dialog box for selecting the default template

In the dialog box that pops up (Fig. 18.5), select the template to be used by default. Click **OK** to save or **CANCEL** to cancel.

Clicking on the left-hand side of the **Report**  button afterwards will create a report based on the template that was selected by default.



### 18.2.3 Saving a Report

---

Functionality is available in the **Pro** edition

---

If there are any unsaved changes in the report text or name, the heading of the report editor window will have an asterisk «\*» symbol.

To save a report, click the **SAVE**  button on the editor toolbar. The report will be saved as a special **SR** series in the current study. The name and description of the series corresponds to the name of the report. If you click the **SAVE**  button again, the changes will be saved in the current SR series. A thumbnail for a series with a report is shown in Fig. 18.6.

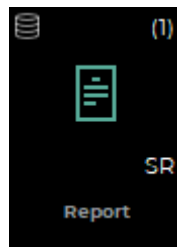



Figure 18.6: Thumbnail for a series with a report

To create a new SR series with a report click the **Save as**  button on the editor toolbar. In the dialog box that pops up, enter the name of the new report. By default, the name of the current report or a transformed name of the current report (if the current name is inadmissible) is shown in the dialog box. The work will be continued in the new SR-series report.

The name of the report is considered inadmissible if it is the same as the name of another report or if it contains inadmissible symbols (see Section 18.1.1). When the report is saved, the program automatically replaces inadmissible symbols in the file name with «\_»; spaces in the beginning and dots in the end of the name are deleted. If there is a name conflict, a number in parentheses will be added to the name.

## 18.2.4 Exporting a Report

---

Functionality is available in the **Pro** edition

---

The DICOM Viewer provides an opportunity to export a report in a PDF file or a DICOM DOC series.

To export a report in a PDF file, click the **Export**  button on the editor toolbar and select the **Export to PDF file...** option. In the dialog box that pops up, select the place where you want to save the PDF file and enter the name of the file. The name of the report is used as the file name by default. Click **Save** to save the PDF file or **Cancel** to cancel.

If the file name contains inadmissible symbols, an error message will pop up (see Section 18.1.1).

To export a report in a DICOM DOC series, click the **Export**  button on the editor toolbar and select the **Export to DICOM DOC series** option. The name of the report is considered inadmissible if it is the same as the name of another report. If there is a name conflict, a number in parentheses will be added to the name. A new **DOC** series is created as a result of export. This series is saved in the current study.

## 18.2.5 Viewing and Editing a Report

---

Functionality is available in the **Pro** edition

---

There are several ways to open a created report for viewing or editing:

1. Double-click with the left mouse button on an SR series thumbnail on the series panel.
2. Select an SR series thumbnail and click the **Report**  button on the toolbar.
3. Drag an SR series thumbnail to the study list window.
4. Drag an SR series thumbnail to the flat image viewer window.

You can edit the report name and contents. Save the edited report (for details see Section 18.2.3).

## 18.3 Report Template

---

Functionality is available in the **Pro** edition

---

The DICOM Viewer provides an opportunity to create report templates to simplify work with reports.



### 18.3.1 Creating an Empty Template

Functionality is available in the **Pro** edition

To create a new report template, on the main menu, select **File->Report template->Create->Empty template**. By default, an empty report template named **Untitled** is created. The Template Editor window differs from the Report Editor window only by the fact that the  icon is displayed in the upper left corner, by which you can visually distinguish the Template Editor from the Report Editor.

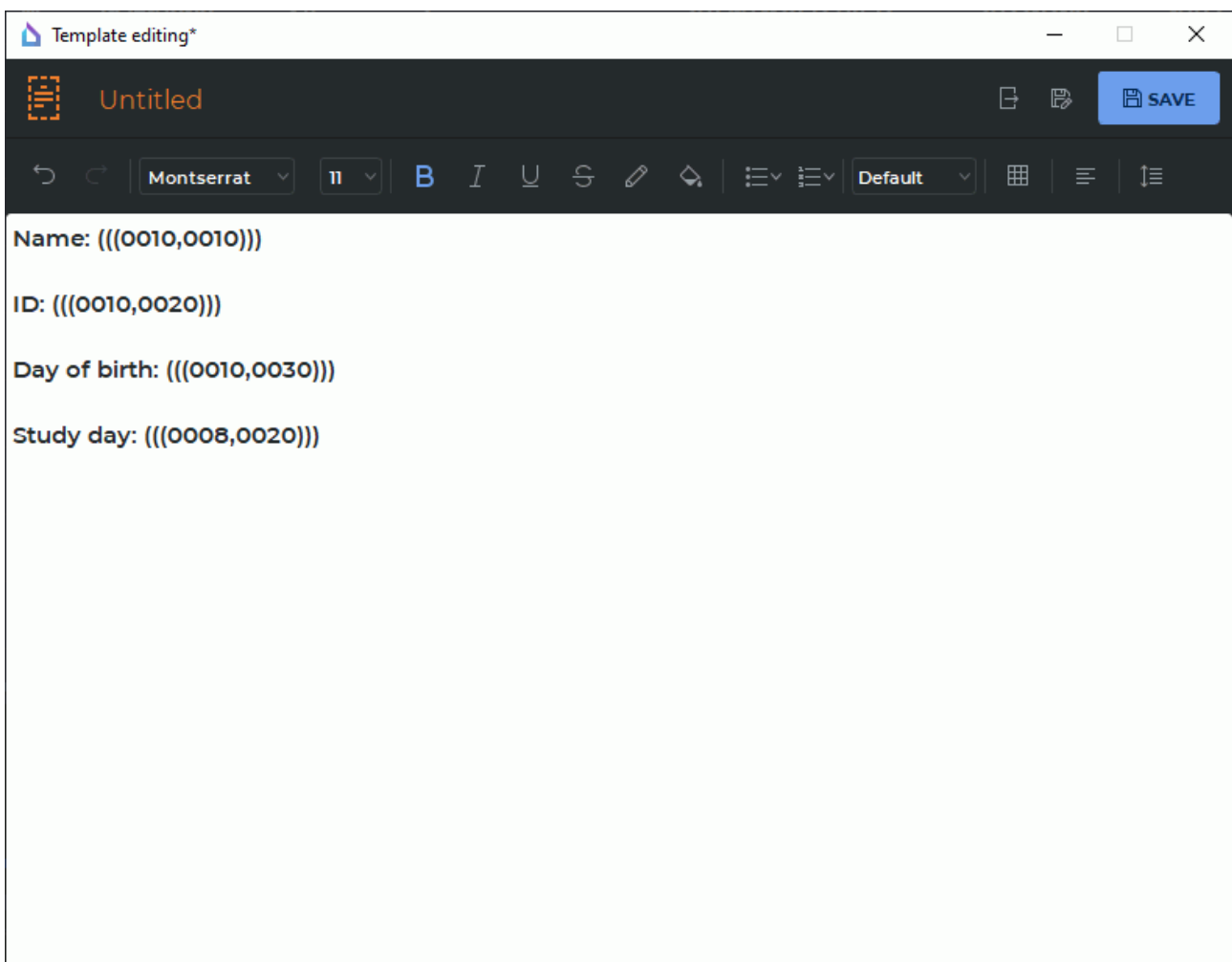

Figure 18.7: Editing the report template

In a template, you can provide for DICOM tags for substitution of values taken from series. Code names of the tags provided by the user are to be separated by commas, no spaces, and enclosed in triple parentheses. In Fig. 18.7, you can see tags for substitution of the patient data and the date of the study.

When a report is created on the basis of a template, tags in triple parentheses are replaced with the respective tag values from the selected series.

### 18.3.2 Loading a Report Template from a File

---

Functionality is available in the **Pro** edition

---

To load a report template from a file, on the main menu, select **File->Report template->Create->Load from file...** In the dialog box, select the template file and click **Open**.

### 18.3.3 Exporting a Report Template

---

Functionality is available in the **Pro** edition

---

The DICOM Viewer provides an opportunity to export a report template to a file.

To export a report template to a file, click the **Export to file**  button on the editor toolbar. In the dialog box that pops up, select the place to save the file and enter the file name. By default, the name of the report template is used as the file name. Click **Save** to save the report template in a file or **Cancel** to cancel.

### 18.3.4 Viewing and Editing a Report Template

---

Functionality is available in the **Pro** edition

---



**Report templates can be edited only in the DICOM Viewer report editor. If you use third-party software for this purpose, it may result in impossibility to read the file.**

To edit a report template, on the main menu, select **File->Report template->Edit** and choose the name of the template. The selected report template will be opened in the template editor window. Edit the name and the contents of the template. Save the edited report template.

### 18.3.5 Saving a Report Template

---

Functionality is available in the **Pro** edition

---

If there are any unsaved changes in the template text or name, the heading of the template editor window will have an asterisk \* symbol.

To save the report template, click the **SAVE**  button on the editor toolbar. The name of a report template is considered inadmissible if it is the same as the name of another template or if it contains inadmissible symbols (see Section 18.1.1). When a template is saved, the program automatically replaces inadmissible symbols in the file name with «\_»; spaces in the

beginning and dots in the end of the name are deleted. If there is a name conflict, a number in parentheses will be added to the name.

A report template is saved as a file in a separate *ReportTemplates* directory in the local storage and set as the current in the template editor window.

If you click the **SAVE**  button again, the changes will be saved in the current template.

To save a template with a new name, click the **Save as**  button on the editor toolbar. In the dialog box that pops up, print the name of the new report template. By default, the name of the current report template or a transformed name of the current report template (if the current name is inadmissible) is shown in the dialog box. Click **OK** to save or **CANCEL** to cancel.

The new report template will be added to the **Report**  button drop-down menu and to the **Edit** and **Remove** items of the list of templates on the main menu **File->Report template**.

### 18.3.6 Deleting a Report Template

---

Functionality is available in the **Pro** edition

---

To delete a template, on the main menu, select **File->Report template->Remove**, and choose a template from the list. In the dialog box that pops up, click **REMOVE** to delete or **CANCEL** to cancel.

When a template is deleted, the respective file is deleted from the *ReportTemplates* folder in the local storage. At the same time, the report template is deleted from all the menus.

# Chapter 19

## Print Images

The DICOM Viewer allows you to print images on paper or film using DICOM printers.

You must add images to the print list, then open the list in the preview window and print the images.

### 19.1 Working with Print List

To print images, you should add them to the print list first. You can do this in the following windows:





- View Flat Images window;
- Multiplanar Reconstruction window;
- Volume Reconstruction window;
- Planning of Pedicle Screw Installation window;
- Coronary Artery analysis window;
- PET Analysis window;
- Series Fusion window.



Depending on the way the image is captured, you can change the window level and width in the print preview window (in this case, the labels on the screen are not captured) or cannot change the window level and width (in this case the image is captured with all the labels and annotations). For details, see the next Sections.

If the **Add to print list** button is inactive, click the left button on the header of the window with the image to be printed or removed.

The print list is saved until the program is closed.



### 19.1.1 Add/Delete Images in View Flat Images and Fusion windows

To add the current image to the print list, click on the **Add to print list**  button. The button will look as follows: . When browsing images, the button will look like this  if the current image is not on the print list, and like this  if it is. If there are several image views opened in the tab, note which view window is active (highlighted by a red frame).

To remove the current image from the print list, click on the **Add to print list** button that should look like this: . The image will be removed, and the button will change to . Also, you can remove images in the Preview window (see Section 19.2).

In the View Flat Images and Fusion windows, there are two image capturing modes for printing:

- **View screenshot:** the entire image, including the labels and annotations, is captured. There is no capability to change the window width and level in the Preview window.
- **Image capture:** only the image of tissues is captured. There is a capability to change the window width and level in the Preview window.

When you click on the **Add to print list**  button, the previously selected capture mode is used. To switch the capture mode, click the arrow on the right of the **Add to Print List**  button and select the target mode. The selected mode is marked with a flag and saved as the default capture mode for the View Flat Images and Series Fusion windows.

If the image was captured in the Series Fusion window, then changing the window width and level in the Preview Window is possible only for the first layer.

A filter applied to an image is taken into account when the image is added to the print list (see Section 2.6).





**An image to which a filter has been applied is not original, and the measurement results may be inaccurate.**

### 19.1.2 Add Images in Multiplanar Reconstruction and Volume Reconstruction windows

To add the current image to the print list, click on the **Add to print list**  button.

In the Multiplanar Reconstruction and Volume Reconstruction windows, there are three image capturing modes for printing:

- **View screenshot:** the entire image, including the labels and annotations, is captured. There is no capability to change the window width and level in the Preview window.
- **Image screenshot:** only the image of tissues is captured. There is no capability to change the window width and level in the Preview window.
- **Entire image:** only the image of tissues is captured. There is a capability to change the window width and level in the Preview window (except the images captured in the Volume Reconstruction window).

When you click on the **Add to print list**  button, the previously selected capture mode is used. To switch the capture mode, click the arrow on the right of the **Add to Print List**  button and select the target mode. The selected mode is marked with a flag and saved as the default capture mode for the Multiplanar Reconstruction, Volume Reconstruction windows.

If the fused image was captured in the **Entire image** Mode in the Multiplanar Reconstruction Window, then changing the window width and level in the Preview Window is possible only for the first layer.

Deletion of the images captured in these modes is available in the Preview window (see Section 19.2.3).

A filter applied to an image is taken into account when the image is added to the print list (see Section 2.6).



**An image to which a filter has been applied is not original, and the measurement results may be inaccurate.**

### 19.1.3 Add Series and Clear Print List

To add an entire series to the print list, click on the arrow on the right side of the **Add to print list** button and select the **Add entire series. Images will be added with default mode** menu item. This functionality is available only for the View Flat Images and Fusion windows.

When a complete series is added to the print list, the filters applied are ignored.

To clear the print list, click on the arrow on the right side of the **Add to print list** button and select the **Clear print list** item.

### 19.1.4 Add Images from Different Studies

If the print list is not empty, and you are trying to add an image from another study, the DICOM Viewer will return a warning **You are trying to add image from different study**.

To add the image, click **YES**. To clear the print list and add the current image, click **REWRITE**. To cancel the addition and leave the current print list as it is, click **NO**.

## 19.2 Edit print list in Preview window

### 19.2.1 Preview

The Preview windows are intended to control the printing and final editing of the print list. The **Preview** window is used to view printing on paper and save images to a pdf file, the **DICOM Preview** is used for printing on film. To open the target window, select the **File** menu and the **Preview** item or the **DICOM Preview** item. The settings made in one window do not affect the settings in the other one except deleting images. The print list is common for both windows, hence, the images deleted in one of the windows are deleted from the print list, and they disappear in the other window.

The **DICOM Preview** tab is shown in Fig. 19.1.

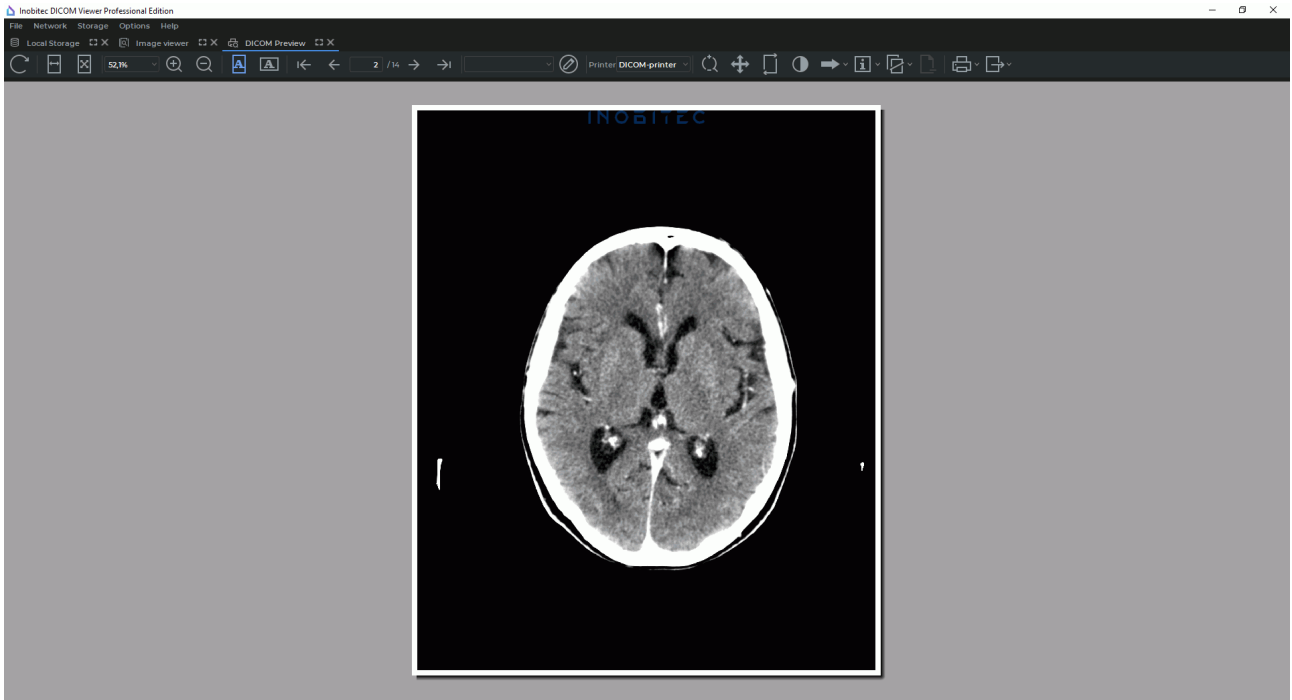

Figure 19.1: DICOM preview window

The toolbar is located at the top (Fig. 19.2), and the bottom part shows what the printed images will look like (preview page).

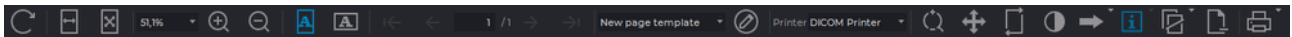



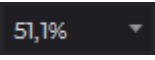







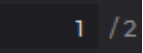

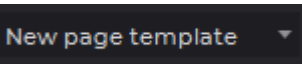

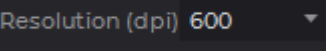
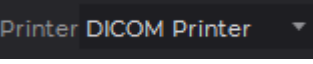

















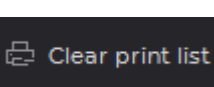

Figure 19.2: Toolbar

The toolbar contains the following elements:

	The <b>Update</b> button refreshes the preview page after the print list has been changed
	The <b>Fit width</b> button adjusts the preview page size to the screen width
	The <b>Fit page</b> button adjusts the preview page size to the tab size
	The <b>Page scale</b> field. The scale is entered from the keyboard manually or selected from the dropdown menu. To open the dropdown menu, click on the arrow  on the right side of the panel
	The <b>Zoom in</b> button zooms in the page. The current scale is displayed in the <b>Page scale</b> field

	The <b>Zoom out</b> button zooms out the page. The current scale is displayed in the <b>Page scale</b> field
	The <b>Portrait</b> button sets the portrait layout for the page
	The <b>Landscape</b> button sets the landscape layout for the page
	The <b>First page</b> button is used to jump to the first page if the images do not fit into a single page
	The <b>Previous page</b> button is used to jump to the previous page if the images do not fit into a single page
	Page input field. It shows the current page and the total number of pages. To go to the page you need, print its number and press the <b>Enter</b> key on the keyboard
	The <b>Next page</b> button is used to jump to the next page if the images do not fit into a single page
	The <b>Last page</b> button is used to jump to the Last page if the images do not fit into a single page
	Page template drop-down list. It allows to select a predefined page template (see Section 19.2.2)
	The <b>Edit page template</b> button opens the Page Template Settings dialog (see Section 19.2.2)
	The <b>Resolution (DPI)</b> drop-down list (only for the <b>Preview</b> window). The list allows to set print resolution (clarity)
	The <b>Printer</b> dropdown menu (only for the <b>DICOM Preview</b> window). It specifies the DICOM printer
	The <b>Zoom</b> tool allows to zoom selected images
	The <b>Pan</b> tool allows to shift selected images inside cells
	The <b>Reset transformation</b> tool allows to reset all the transformations made using the <b>Zoom</b> and <b>Pan</b> tools
	The <b>Adjust W/L</b> tool allows to change the window width and level
	The <b>Arrow tool</b> allows to make graphic labels such as arrows. For details on how to do it see Section 2.32
	The <b>Pencil tool</b> allows to build freeform contours. For details on how to do, it see Section 2.32



	The <b>Text tool</b> allows to make text labels. For details on how to do, it see Section <a href="#">2.32</a>
	The <b>Ellipse</b> tool allows to make graphic labels such as an ellipse. For details, on how to do it see Section <a href="#">2.32</a>
	The <b>Rectangle</b> tool allows to make graphic labels such as an rectangle. For details, on how to do it see Section <a href="#">2.32</a>
	The <b>Polygon</b> tool allows to make graphic labels such as a polygon. For details, on how to do it see Section <a href="#">2.32</a>
	The <b>Remove all annotations</b> tool removes all annotations from the image. For details, on how to do it see Section <a href="#">2.19.12</a>
	The <b>Show labels</b> tool allows to show the information about an image. For details, on how to do it see Section <a href="#">19.2.4</a>
	The <b>Show reference image</b> tool allows to display a reference image. For details, on how to do it see Section <a href="#">19.2.5</a>
	The <b>Remove selected images</b> button allows to remove selected images from the print list (see Section <a href="#">19.2.3</a> )
	The <b>Page setup</b> (only for the <b>Preview</b> window) opens the print settings dialog
	The <b>Print</b> button opens the print dialog
	The <b>Clear print list</b> command removes all the images from the print list. To use it, click the arrow on the right side of the <b>Print</b> button and select the <b>Clear print list</b> item
	The <b>Export to PDF</b> tool (only for the <b>Preview</b> window) saves images to a pdf file

## 19.2.2 Set Up Page Templates

The Page templates tool allows you to arrange images in arbitrary order. After the program has been installed, the following templates will be available:

- one image on the screen;
- two images, one on top of the other;
- 2x2 grid;
- 3x2 grid.

To open the page template editing dialog, click the **Edit page template**  button. The dialog box for the print preview window is shown in Fig. [19.3](#). For the DICOM preview tab, in

the dialog box, instead of the **Spacing** parameter you will see a drop-down menu for choosing the film size.

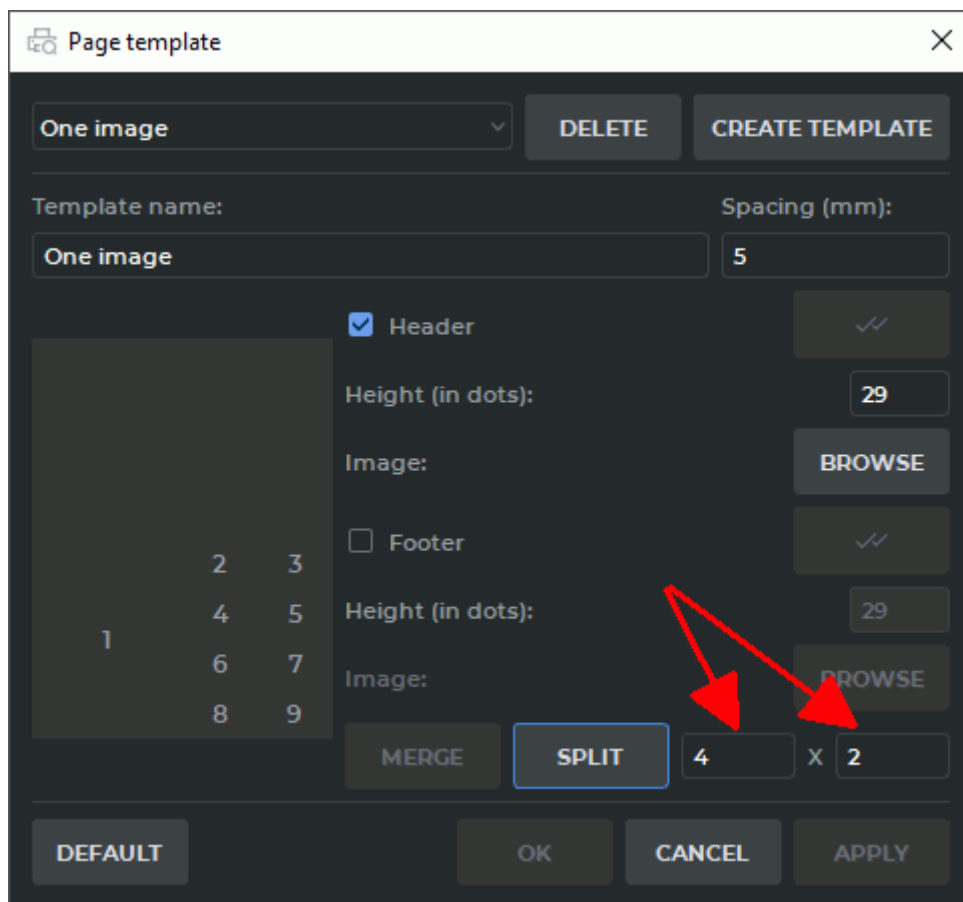

Figure 19.3: Page template settings dialog

Select the desired template from the drop-down list. To add a new template, click the **CREATE TEMPLATE** button, to delete a template, click the **DELETE** button.



**Attention! Deleting a template cannot be undone.**

To change a template name, enter a new name in the **Template Name** field.

For the **Preview** tab set the space between images in the **Spacing (mm)** field.

For the **DICOM preview** tab, choose the film size from the “Film size” drop-down menu. The default value is **Chosen film size for printer**. If this value is chosen, the size of the film will be as set for your printer. The DICOM printer settings are described in Section 19.3.2. If you choose a different value for the printing template, the size provided for by the printer settings will be ignored.

On the left-hand side of the window you see the arrangement of images on the page. To divide any cell into any number of lines and columns, left-click on that cell to select it and enter the required number of lines and columns in the left and the right fields indicated by the arrows in Fig. 19.3. Then click **SPLIT**.

If the column and/or row count is greater than 1, you can merge an arbitrary number of cells. The merged cells must form a rectangle. For example, set the Row count to 3 and the

Column count to 4. Next, select cells 7, 8, 11, 12. To do it, move the cursor from cell 7 to cell 12, holding the left mouse button. Next, click **MERGE**. The four selected cells will be merged.

To split any cell into an arbitrary number of rows and columns, select this cell, enter values in the **rows** and **columns** fields and click the **SPLIT** button. The cells made by splitting can only be merged with each other.

The cells created in such a way can only be merged with other cells from the same group.

To add the header and/or the footer, proceed as follows:

1. Check the **Header** box to add the header and the **Footer** box to add the footer. The header and the footer will be shown in the scheme representing the cell arrangement.
2. Specify the header/footer height in points.
3. Choose an image for the header/footer. To do that, click the **BROWSE** button and choose a file with **jpg, jpeg, jpe** or **png** extension in the dialog box that pops up.
4. To use this header/footer for all the templates without a header/footer (including the new templates by default), click the **Set this header as default**  or **Set this footer as default**  button in the dialog box. Then click **YES** to apply or **NO** to cancel.

To save the changes, click **OK** or **APPLY**, to cancel, click **CANCEL**.

### 19.2.3 Cells

If the page template contains several cells, then to apply the **Zoom, Pan, Adjust W/L** tools to several images on one page or to delete an image (images), you need to select the corresponding cells. To select, click the left mouse button on the cell. To remove a selection, click on the image again. To select multiple cells:

- To select multiple cells that are contiguous (next to each other): click on the first cell and click on the last one, holding the **Shift** key on the keyboard.
- To select multiple cells that are anywhere on the page: click the left mouse button on each one, holding the **Ctrl** key on the keyboard.
- To remove a selection, click on the any selected cell again.





**Warning! If any of the graphic label tools or one of the «Zoom», «Pan», «Adjust W/L» tools is active, selection and removing of the selection are not available.**

To remove the images in the selected cells click the  **Remove selected images** button.

To swap images in cells, drag an image to the target cell, holding the left mouse button. The images will be swapped.

### 19.2.4 Print Labels

If an image is captured without labels, you can add them in the Preview Window. To do it, click the  **Show labels** button. The tags that should be displayed are marked with flags. To

display or hide a label, click the arrow on the right side on the  **Show labels** button and select the target item.

To set the font size, select the **Show annotation text size...** item in the button menu.





To select the DICOM tags that should be displayed in the left-hand bottom corner, select the **Set visible tags...** item in the button menu and in the dialog that appears mark the target tags with flags.

If one or more cells are selected, the settings will be applied only to these cells.

### 19.2.5 Reference image

The DICOM Viewer provides an opportunity to add reference images to the print list. You can ascribe the same reference image to all the images on the list, or a different image to each of the images on the list. To ascribe several reference images to each study added to the print list, you can create a separate list of reference images.

To add a reference image:

1. Choose an image from the same study that has been added to the print list. Click the arrow on the right side of the **Add to print list**  button and select the **Add as reference image** item. This image will by default be ascribed to all the images from the same study included in the print list.
2. If you need to add a new reference image to the list or replace it with a different one, repeat the previous step. You will see a notification that a reference image has already been added. To add another reference image to the list, click the **YES** button; to replace the previous reference image, click the **REWRITE** button, to cancel, click the **NO** button.
3. Open the Preview or DICOM Preview window. If the **Show reference image**  tool is inactive, activate it with the left mouse button. A reduced reference image is displayed in the corner of each image. If there is more than one image on the list of reference images, the first image added to the list will be displayed.
4. To adjust the display of the reference image, click the arrow on the right side of the **Show reference image**  button and select the **Reference image settings...** item. You can set up the following properties:
  - image alignment;
  - dimension ration;
  - project line width (mm).
5. To replace the reference image attributed to a separate image, highlight it and click the arrow on the right side of the **Show Reference Image**  button, then click the **Select Reference Image...** button. Choose the image you need in the dialog box and click **CHOOSE**. If no image has been selected, the reference image will be changed for all the images on the print list. If there are images from different studies on the print list, the reference image can be changed only for the images selected. The **Select Reference Image...** function is also available in the right-click menu.

6. To delete a reference image from the list, click the arrow on the right side of the **Show Reference Image**  button, then click **Select Reference Image...** item. Choose the image you need in the dialog box and click the **DELETE** button.

7. To hide/show a reference image, click the **Show Reference Image**  button. If there are some images selected, the action will be performed only for them.

If there are images from different studies on the print list, reference images will be ascribed to them separately.

## 19.3 Print Images on Film

### 19.3.1 Set Up DICOM Printers

To set up the DICOM printing parameters, select the **Network** menu and the **DICOM printer setup...** item. The window shown in Fig. 19.4 will be displayed.

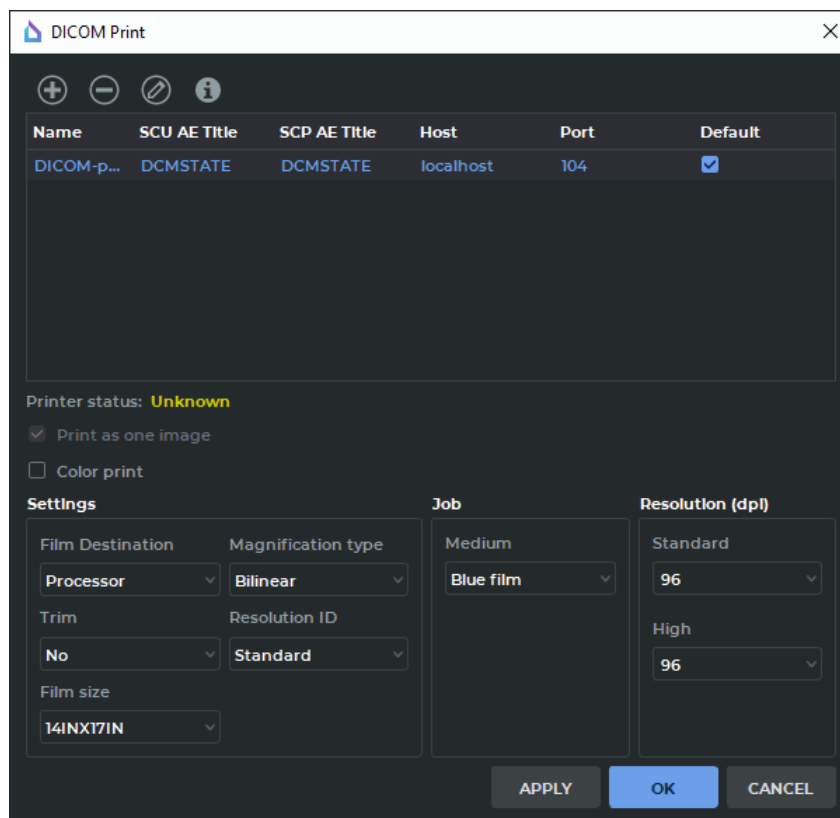



Figure 19.4: DICOM printing settings window

To add a DICOM printer to the list:

1. Click the **Add printer**  button on the toolbar. The printer setup dialog box (Fig. 19.5) will be displayed.

2. Enter a user-defined printer name into the **Name** field.
3. In the **SCU AE Title** field, enter the name of the client allowed to access the printer (this parameter is defined in the printer settings).
4. In the **SCP AE Title** field, enter the printer name (this parameter is defined in the printer settings).
5. Enter the printer network address in the **Host** field.
6. Enter the printer port in the **Port** field.
7. Check the **Default** box if the printer should be used by default.
8. Click **OK** to apply the changes or **CANCEL** to cancel them. To save the information without closing the window, click **APPLY**.

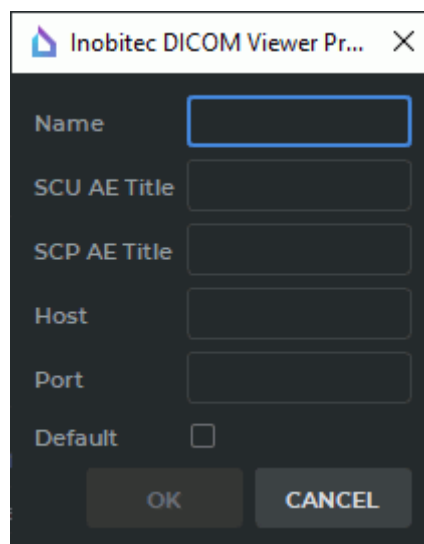





Figure 19.5: DICOM printer setup dialog box

All the added printers will appear on the printer list. The default printer can be assigned directly from the list by checking the box next to the printer.

To delete a printer from the list, select it and click the **Remove printer**  button. Click **YES** in the confirmation dialog to delete the printer or **NO** to cancel the deletion.

To edit the printer settings, select the printer and click the **Edit printer**  button.

To check whether a printer is available, select it and click the **Info printer**  button. If the printer is available, the printer list will display the **Online** status for the printer. If not, the **Offline** status will be displayed. If the status has not been checked, its value will be **Unknown**.

### 19.3.2 Set Up DICOM Printing Parameters

To set up the DICOM printing parameters, select the **Network** menu and the **DICOM Printer setup...** item. The window shown in Fig. 19.4 will pop up.



**The settings must be in strict compliance with the specification for the DICOM printer.**

Set the required parameters on the printing setup panel:

1. Set the film source (**Unit** or **Processor**).
2. Set the film cutting.
3. Set the magnification type. If you need to print the images with the original resolution, select **None**. If you need to fit the images to the film size, select one of the magnification types (**Bilinear**, **Cubic** or **Replicated**). In this case, the printer will change the image resolution according to the selected algorithm to maximize the image size on the page and retain its proportions.
4. Select the resolution to print the images (**Standard** or **High**). Set the print quality in DPI (dots per inch) for the options **Standard** and **High**.
5. Choose the film size from the **Film size** drop-down menu.
6. Choose the media type from the **Medium** drop-down menu.
7. Since version 1.11, you can not deactivate the **Print as one image** option.
8. If necessary, enable the printing of labels.
9. For color printing check the **Color print** box.

You can also specify the film size in the tab for setting the page templates. If the **Chosen film size for printer** parameter has been chosen, the size of the film will be as set for your printer. Otherwise, the size of the page template will be used (see Section 19.2.2).

### 19.3.3 Setting Up the Default DICOM Print Parameters

Certain makes of DICOM printers may not support some print parameters described in the DICOM standard. If a parameter passed to the printer is not supported, an attempt to print may fail. To prevent such errors, the DICOM Viewer provides for an opportunity not to specify certain parameters and not to pass them to the DICOM printer.

To set up the default DICOM printing parameters, select the **Network** menu and the **DICOM Printer setup...** item.

In the **DICOM Print** dialog box (Fig. 19.6), the user may choose **Default** values for the following parameters:

- **Film Destination;**
- **Trim;**
- **Magnification type;**

- **Medium.**

A **Default** value means that the value has not been specified and is to be determined by the DICOM printer.

The values for the **Film size** and **Resolution (dpi)** parameters must be chosen from the drop-down lists.

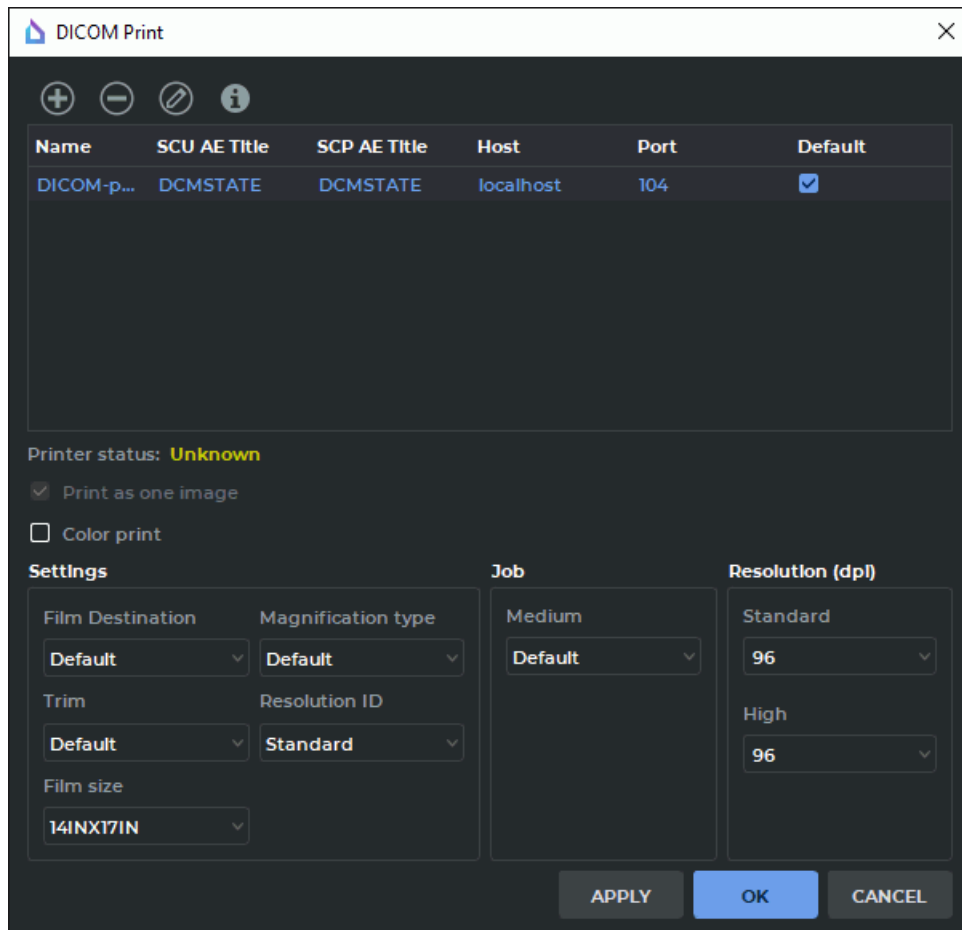



Figure 19.6: DICOM printing settings by default

### 19.3.4 Print

You can print images on a DICOM printer from the DICOM preview window (see Section 19.2). To open it select the **File** menu and the **DICOM Preview** item. To print images on a DICOM printer, click the **DICOM print**  button on the toolbar. The window shown in Fig. 19.7 will be displayed.



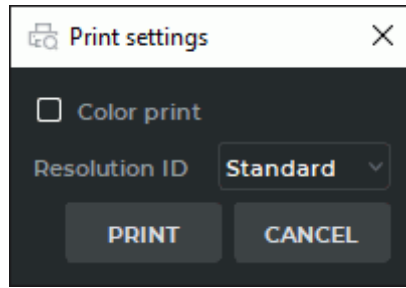

Figure 19.7: DICOM print

The parameters in the window correspond to the default parameters specified during the printing setup. Change these parameters if necessary and click the **PRINT** button to initiate the printing or **CANCEL** to cancel.

If the printer is not available the message like **Printer «PrinterName» is not available** will be displayed.

## 19.4 Print Images on Paper

For this purpose, a printer for printing on paper should be connected to your computer and set up. The DICOM Viewer does not have the functionality to set up such a printer.

Printing on paper is possible from the preview window (see Section 19.2). To open it, select the **File** menu and the **Preview** item. The **Preview** tab will be displayed.

The preview window is similar to the DICOM printer preview window, except the **Print setup**  button on the toolbar opening the printing system settings. Printing is carried out by the OS facilities. If necessary, consult the printer manual and the OS help reference.

To enable/disable printing annotations, click the **Show labels**  button on the toolbar. To set the displayed annotation parameters, press the arrow on the right-hand side of the **Show labels** button (for details see Section 2.26).

## 19.5 Printing Pages Export

The DICOM Viewer provides an opportunity to export pages for printing to the default DICOM server or to the local storage. The default DICOM server settings have been described in Section 13.2. The image is exported in compliance with the current print settings.



### Attention! The red frame shows the images to be exported

Export to the local storage is performed regardless of whether or not the images have been successfully uploaded to the DICOM server. Each time the same set of pages is exported, a new series is created in the local storage.

To export the current page, click the  **Export page to default server** button. To export all the pages containing images for printing, click the arrow on the right side of the **Export page to default server** button and choose the **Export all pages** item.

# Chapter 20

## Integration

### 20.1 Launch from the Command Line



**Attention! On macOS, command line parameters are not supported.**

If the DICOM Viewer has already been launched on the computer, the command line parameters will be sent to the program that has been launched. The program will not be launched again (see **Launch multiple instances of the program**).

Launching the program from the command line allows you to set specific parameters for the current session of the program, change the settings and get help information about the command line options. To launch the DICOM Viewer use the following syntax on the command line:

```
[<path_to_the_program>]<executable_program> [ --help ] \ [--study-folder <path> [--open-series-images | --open-series-mpr | --open-series-volume | --open-series-endoscopy [--series-uid <uid> | --series-index <index>]]] \ [--pacs-aetitle <aetitle> [--patient-id <patientID>] [--study-uid <studyUID>] [--series-index <seriesIndex> | --series-uid <seriesUID>] [--open-series-images] \ [--aet <aet>] \ [--import-settings <path>] [--use-imported-listener-aetitle | --aet <aet>] [--update-scu-aetitle] \ [--export-settings <path>]
```

**--help:** display the help information about the command line options, exit the program.

**--study-folder <path>:** display the study (studies) contained in the specified folder. If there are several studies, then the following options are applied to the first study in the list:

**--open-series-images:** display the first series in the flat image view window

**--open-series-mpr:** display the first series in the multiplanar reconstruction window

**--open-series-volume:** display the first series in the volume reconstruction window

**--open-series-endoscopy<sup>PRO</sup>:** display the first series in the virtual endoscopy window

Any of these parameters can be used with the following parameters:

**--series-uid <seriesUID>:** show the series with the specified seriesUID

**--series-index <seriesIndex>**: show the series with the specified seriesIndex

**--pacs-aetitle <aetitle>**: attempt to open study list from PACSServer which AE Title matches the specified AE Title. The following options can be used with this option in different combinations:

**--patient-id <patientID>**: show the study with the specified patientID. Parameter has higher priority than --study-uid

**--study-uid <studyUID>**: show the series with the specified studyUID

**--series-uid <seriesUID>**: select the series with the specified seriesUID. If several studies are found, the first one on the list is used

**--series-index <seriesIndex>**: select the series with the specified seriesIndex. If several studies are found, the first one on the list is used

**--open-series-images**: display the selected series in the flat image view window. If a series is not selected, the first one of the first study is used

Example: `C:\Users\user\DICOMViewerPro1.9.1\viewer.exe --study-folder D:\dicom_data --open-series-images --series-index 1` shows series with seriesIndex 1 of the first study from the `D:\dicom_data` folder in the Flat images view window.

If the option is wrong, then the help information about the command line options is displayed, and the program exits. If the option value is wrong (e.g. there are not DICOM data in the specified folder, there is no series with the specified seriesUID or seriesIndex), then this and all subsequent options are ignored.



**Attention! If some AE Titles of several PACSServers match, then data will be searched on the first PACSServer on the list. PACSServers are sorted by the «Server nickname» field.**

For details on how to set up connection to PACSServer, see Section 13.2.

The length of AE Title value shall not exceed 16 characters. Cyrillic letters and «\» symbols in AE titles are not allowed.

The following options are used to change the settings. After executing any of these commands, the program exits. In case of a successful execution, the word **Done** appears on the command line.

**--aet <aetitle>**: parameter AE Title for DICOM Listener is set to <aetitle>

**--import-settings <file>**: imports settings from <file>

**--use-imported-listener-aetitle**: parameter AE Title for DICOM Listener is set to value from <file>

if the option **--aet <aetitle>** is used at the same time then AE Title for DICOM Listener is set to <aetitle>

**--update-scu-aetitle**: Client name (SCU) for PACS Servers of the DICOM Listener will remain the current

if the option **--aet <aetitle>** is used at the same time then Client name (SCU) for PACS Servers is set to <aetitle>

**--export-settings <file>**: exports settings to <file>.

## 20.2 Launching the DICOM Viewer with a URL Command

The DICOM Viewer may be launched by clicking the link on the web browser page.

If the DICOM Viewer has already been launched on the computer, the URL parameters will be sent to the program that has been launched. The program will not be launched again (see **Launch multiple instances of the program**).

### 20.2.1 Enabling the DICOM Viewer Launch with a URL Command on Windows

To enable the DICOM Viewer launch with a URL Command on Windows, the DICOM Viewer must be registered in the URI system as *inobitec*.

The DICOM Viewer is automatically registered in the URI system when the software is installed. To enable the support of the DICOM Viewer launch with a URL Command, check the **Register the schema «inobitec» to launch a viewer with parameters from browser** box in the **Extended parameters** window (Fig. 7). By default, the box is not checked. If this option has been activated, administrator privileges will be required in the process of software installation. When the DICOM Viewer is deleted, it remains registered in the URI system.

### 20.2.2 Enabling the DICOM Viewer Launch with a URL Command on Linux

In order to enable the DICOM Viewer launch from a browser on Linux, when the *Applmage* file is run for the first time, it must be integrated with the system. A support program, such as *ApplmageLauncher* may be required for the OS to make an integration request.

When the application is integrated, the scheme is registered for the current user (the desktop file from *Applmage* is installed in *~/local/share/applications*).



**The Firefox browser installed with Snap or Flatpack deployment utilities will not follow any third-party URI schemes due to the security policy.**

### 20.2.3 Enabling the DICOM Viewer Launch with a URL Command on macOS

The support of the DICOM Viewer launch from a browser on macOS is enabled automatically when the DMG file with the application is opened.

To reset the scheme provided, use the following command:

```
/System/Library/Frameworks/CoreServices.framework/Frameworks/LaunchServices.framework/Support/lsregister -u <Path to the installed app file>
```

### 20.2.4 Launching the DICOM Viewer with the help of a URL Command

To test the DICOM Viewer launch, enter the *inobitec://* command in the address bar of the browser.

The DICOM Viewer window will be opened after confirmation of the request.

The following parameters (in the **key=<value>** or **key** format) are available for URL requests:

**study-folder=<path>** — the path to the directory with the study files. If there are several studies, then the following options are applied to the first study in the list:

**open-series-images** — display the first series in the flat image view window

**open-series-mpr** — display the first series in the multiplanar reconstruction window

**open-series-volume** — display the first series in the volume reconstruction window

**open-series-endoscopy** — display the first series in the virtual endoscopy window

**study-uid=<study\_uid>** — the unique identifier (UID) of the study containing a series to be opened by the image viewer

**series-uid=<series\_uid>** — the unique identifier (UID) of the series to be opened

**series-index=<series\_index>** — the index of the series to be opened

**patient-id=<patient\_id>** — the identifier of the patient, for whom the study list is to be opened

**pacs-aetitle=<pacs\_aetitle>** — provide the AE Title for the PACS server. Only the following command can be used with this option:

**open-series-images** — open the first series in the flat image view window

The following format of the URL command is used for launching the DICOM Viewer

**inobitec://?param\_1="value\_1"&...&param\_m=&...&param\_n="value\_n"**

In this format, the **param\_m** parameter has no value. Quote symbols must be replaced by the respective code designations. It is also recommended to replace any symbols different from letters and numbers by code designations in the names of parameters and values.

Below you can see some examples of console commands and respective URL commands.

#### Example 1.

**viewer.exe --study-folder "D:/DicomData/001" --series-index "0" --open-series-mpr** console command corresponds to

**inobitec://?study%2Dfolder=%22D%3A%2FDicomData%2F001%22&series%2Dindex=%220%22&open%2Dseries%2Dmpr=** URL command.

In the multiplanar reconstruction window, the command opens a series with 0 index of the first study contained in the *D:/DicomData/001*.

#### Example 2.

**viewer.exe --pacs-aetitle "PACS\_Inobitec" --patient-id "9Htqj5c" --open-series-images** console command corresponds to

**inobitec://?pacs%2Daetitle=%22PACS%5Finobitec%22&patient%2Did=%229Htqj5c%22&series%2Dindex=10&open%2Dseries%2Dimages=** URL command.

In the flat image viewer window, the command opens the first series of the first study with *9Htqj5c* patient id, which is placed on the PACS Server with AE Title *PACS\_Inobitec*.

If there is a mistake in the URL request, the DICOM Viewer window is opened, and an error notification is added to the log file. If there is a mistake in one of the request parameters, the other parameters are processed all the same.

## 20.3 HTTP RPC service

The Inobitec DICOM Viewer provides an HTTP RPC Service that allows you to execute commands. Now two commands are supported:

- **DownloadAndOpenStudy**;
- **DisplayStudy**.

### 20.3.1 Command «DownloadAndOpenStudy»

- **DownloadAndOpenStudy** — command allows you to download the study from the PACS Server to the Local Storage and then open it. When this command is received, the DICOM Viewer searches the required study in the Local Storage. If the study is in the Local Storage, then the DICOM Viewer opens its first series in flat images view mode. If the required study is not found in the Local Storage, the DICOM Viewer will send a download request to the PACS Server and after the start of the downloading files will open study in the flat images view mode.

To execute the **DownloadAndOpenStudy** command:

1. In the DICOM Viewer, switch on the DICOM and HIS/HTTP services by selecting the **Services** option on the **Network** menu (for details, see Sections 13.1.1 and 13.1.2).
2. Send HTTP RPC request to open study by sending POST request containing xml file in the special format (e.g. *downloadAndOpenStudy.xml* in the **demo** folder).

Specify the following parameters in the *downloadAndOpenStudy.xml* file:

- **PatientID** (optional) — ID of the patient whose study should be opened;
- **StudyInstanceUID** — UID of the study to be opened;
- **AccessionNumber** — Accession Number of the study to be opened;
- **AET** — AE Title of the PACS Server;
- **IP** — network address of the PACS Server;
- **port** — DICOM port of the PACS Server;
- **CommandType** (optional) — method to download images from the PACS Server to the DICOM Viewer. The values C-GET (by default) and C-MOVE can be used. If you use the C-MOVE method then the PACS Server must be configured appropriately.

The values of the **StudyInstanceUID** and **AccessionNumber**, parameters provided in the *xml* file must belong to the same study. If the **StudyInstanceUID** and **AccessionNumber** parameters do not belong to the same study, you will not be able to download the study.

You may search for and download a study using only the value of the **AccessionNumber** parameter. To do that, delete the values of the **PatientID** and **StudyInstanceUID** parameters from the *downloadAndOpenStudy.xml* file leaving only the **AccessionNumber** and the PACS Server parameters (**AET**, **IP**, and **port**).

If the **AET**, **IP**, and **port** values have not been provided, the study will be downloaded from the DICOM Server (PACS) set by default. If only one or two parameters out of three (**AET**, **IP**, and **port**) have been provided, the command is considered invalid.

Also you can use the test page (*testpage.html* in the **demo** folder):

1. In the DICOM Viewer, switch on the DICOM and HIS/HTTP services by selecting the **Services** option on the **Network** menu (for details, see Sections 13.1.1 and 13.1.2).
2. Open the *testpage.html* file.
3. Fill in the following fields:
  - **AET** — AE Title of the PACS Server;
  - **IP** — network address of the PACS Server;
  - **Port** — DICOM port of the PACS Server;
  - **StudyUID** — UID of the study to be opened;
  - **Destination IP** — network address of the DICOM Viewer;
  - **Destination port** — HTTP port of the DICOM Viewer.
4. Click the «**Send command**» button.

You will find the HTTP RPC service setup instructions, configuration files templates, and test pages at <https://inobitec.com/downloads/dicomviewer/>.

### 20.3.2 Command «DisplayStudy»

- **DisplayStudy** — command allows you to open study from the Local Storage. When this command is received, the DICOM Viewer searches the required study in the Local Storage. If the study is in the Local Storage, then the DICOM Viewer opens its first series in the flat images view mode. At the moment to obtain this command the study should already be stored in the Local Storage.

To execute **DisplayStudy** command:

1. In the DICOM Viewer, switch on the DICOM and HIS/HTTP services by selecting the **Services** option on the **Network** menu (for details, see Sections 13.1.1 and 13.1.2).
2. Send HTTP RPC request to open study by sending POST request containing xml file in the special format (e.g. *displayStudy.xml* in the **demo** folder).

Specify the following parameters in the *displayStudy.xml* file:

- **PatientID** (optional) — ID of the patient whose study should be opened;
- **StudyInstanceUID** — UID of the study to be opened.

Also you can use the *display.bat* test script from the **demo** folder:

1. In the DICOM Viewer, switch on the DICOM and HIS/HTTP services by selecting the **Services** option on the **Network** menu (for details, see Sections 13.1.1 and 13.1.2).

2. Specify the following parameters in *displayStudy.xml* file:
  - **PatientID** (optional) — ID of the patient whose study should be opened;
  - **StudyInstanceUID** — UID of the study to be opened.
3. Execute the script in the command line with the following parameters:  
display.bat [ip] [port]  
where:
  - **ip** — network address of the DICOM Viewer;
  - **port** — HTTP port of the DICOM Viewer.

You will find the HTTP RPC service setup instructions, configuration files templates, and test pages at <https://inobitec.com/downloads/dicomviewer/>.

### 20.3.3 Configuration Files of HTTP RPC service

The templates for configuration files of HTTP RPC remote procedure call service are provided below.

#### «downloadAndOpenStudy.xml»

```
<?xml version="1.0" encoding="utf-8"?>
<methodCall>
  <methodName>DownloadAndOpenStudy</methodName>
  <params>
    <param>
      <value>
        <struct>
          <member>
            <name>PatientID</name>
            <value>
              <string>9Htqj5c</string>
            </value>
          </member>
          <member>
            <name>StudyInstanceUID</name>
            <value>
              <string>1.2.840.113704.1.111.5600.1107858801.1</string>
            </value>
          </member>
          <member>
            <name>AccessionNumber</name>
            <value>
              <string>value</string>
            </value>
          </member>
          <member>
            <name>AET</name>
            <value>
```



```

        <string>PACS_Inobitec</string>
      </value>
    </member>
  <member>
    <name>IP</name>
    <value>
      <string>192.168.0.235</string>
    </value>
  </member>
  <member>
    <name>port</name>
    <value>
      <string>3000</string>
    </value>
  </member>
  <member>
    <name>CommandType</name>
    <value>
      <string>C-MOVE</string>
    </value>
  </member>
</struct>
</value>
</param>
</params>
</methodCall>

```

### «displayStudy.xml»

```

<?xml version="1.0" encoding="utf-8"?>
<methodCall>
  <methodName>DisplayStudy</methodName>
  <params>
    <param>
      <value>
        <struct>
          <member>
            <name>PatientID</name>
            <value>
              <string>9Htqj5c</string>
            </value>
          </member>
          <member>
            <name>StudyInstanceUID</name>
            <value>
              <string>1.2.840.113704.1.111.5600.1107858801.1</string>
            </value>
          </member>
        </struct>
      </value>
    </param>
  </params>
</methodCall>

```

```
        </struct>
    </value>
</param>
</params>
</methodCall>
```

---

# Chapter 21

## Licensing

### 21.1 Trial period

The demo mode allows users to try out the DICOM Viewer using it without any functionality limitations for 14 days. The only requirement is connecting your computer to the Internet. After the 14 day trial period, the DICOM Viewer will go inactive. To continue working with it, you must purchase a license. The trial period for each edition is set separately.

A license key enables you to activate the DICOM Viewer versions released within a year of the key purchase. The versions released after the one-year period are not activated, but the trial period is available for them. To extend the activation period of the new versions for another year, purchase a subscription to updates.

Starting from version 1.11.0, specialized modules can additionally be connected to the Pro edition. Such modules are licensed and paid for separately. The main functionality remains available in the Pro edition.

### 21.2 The First Launch and Licensing

#### 21.2.1 Registration on the License Server Using Internet

When you first start the DICOM Viewer after installing, it will attempt to register itself on the license server. During its registration, the DICOM Viewer does not transmit any personal data.

If you have a license key, select **License...** from the **Help** section of the main menu. In the dialog box that opens (Fig. 21.1), enter the license key and click **OK** to confirm or **CANCEL** to cancel the input. If the license key is not valid, the activation fails.

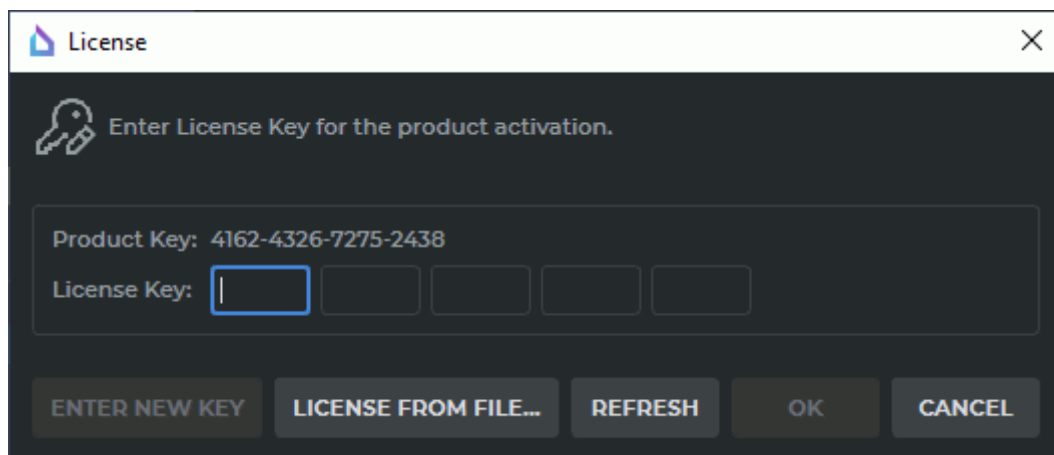

Figure 21.1: License key input dialog box

To close the DICOM Viewer, select **Exit** from the **File** section of the main menu.

The **Lite** and **Pro** editions are registered separately.

If the license key does not support the activation of Additional Modules, and you need to replace it with a new one, click on the **ENTER NEW KEY** button and enter the new key.

### 21.2.2 License Proxy Server for automated corporate licensing

To automatize the licensing of a large number of copies of the program in a company, a License Proxy Server is used. The License Proxy Server must have a permanent connection to the License Server. It is installed on the computer located in the local network of the company, and it loads the set of keys necessary for licensing all the copies of the program. At the first start, the program accesses the License Proxy Server and asks for the key. It saves users the need to enter the license keys. If necessary, additional keys can be loaded into the License Proxy Server.

## 21.3 Purchase of a License

14 days after the activation date of the trial version, a dialog box similar to the one shown in Fig. 21.1 will be displayed upon starting the DICOM Viewer. Further work without the license key input will be impossible.

To purchase a license, follow the <https://inobitec.com/buy/> link.

Send a request for further information to the [market@inobitec.com](mailto:market@inobitec.com) address.

---

# Chapter 22

## Help System and User Assistance

### 22.1 Help System

The Help System is available from the DICOM Viewer interface. To use the Help System, you need to check the box **Help->Assistant** for the required languages during the installation of the program.

The Help System language is the same as the one previously set in the DICOM Viewer. If the help files for selected language are missing, or the Help System is not installed, a dialog with a relevant message appears at the Help System startup. In this case, reinstall the DICOM Viewer and check the box **Help->Assistant** for the required languages during the installation of the program.

The Help System interface language coincides with the language set in the operating system.

#### 22.1.1 Launch the Help System

The Help System is context-sensitive, it allows to open the sections describing the interface elements, the features that are currently in use. There are three ways to launch the Help System:

1. From the main menu. Open the **Help** menu and select the **Contents...** item. The Help System will open on the page containing information about the active tab.
2. From a tooltip. Place your cursor on a button to display a tooltip. If this button corresponds to a page of the help system, then there will be a **Help** link in the tooltip. Click this link to open the Help System page. The tooltips are described in section [22.2](#).
3. Using the hotkey. Place your cursor on the required interface object (button, panel, dialog window, etc) and press the hotkey to open the Help System. If this object corresponds to the interface page, the Help System will be opened on this page.

If the Help System is already running, then it opens the required page.

If the selected interface object does not correspond to any page, the Help System will be opened on the last viewed page.

## 22.1.2 Help System Settings

The default Help System skin coincides with the DICOM Viewer skin. To disable the use of the DICOM Viewer skin, uncheck the **Use the selected style for Help System** box (see Section 16.6).

## 22.2 Tooltips

Tooltips appear while hovering the cursor over a button or another interface element. It contains information about this item.

The tooltip for a button contains the following information:

- button name;
- hotkey (if specified);
- a link to a page in the Help System (if specified);
- a slideshow with a brief demonstration of the instrument capabilities or a view mode (if specified).

A slideshow appears 3 seconds after the appearance of the tooltip and is played back cyclically. After that, to close a tooltip, click a mouse button or rotate the mouse wheel. If there is a slideshow for this button, a countdown appears in the form of points in the lower right part of the tooltip. To display a slideshow, check the box **Slideshow Tips** during the installation of the DICOM Viewer.

The DICOM Viewer allows you to disable the display of hotkey, slideshow or completely disable the tooltips (see Section 16.1).

---

# “Hotkeys”

Most part of the hotkeys can be changed (Chapter 16.8).



**Note that we only use Latin characters for default key combinations. To use a default key combination, switch to the Latin keyboard layout.**

## Accepted Abbreviations

LMB — left mouse button;

RMB — right mouse button;

MMB — middle mouse button;

MW — mouse wheel;

Left — left arrow;

Right — right arrow;

Forward — forward arrow;

Back — back arrow.

## Key Combinations Used in All Windows

For Windows and Linux	For macOS	Effect
Ctrl+S	Command+S	DICOM server list management window
Ctrl+N	Command+N	Network message queue management window
Ctrl+E	Command+E	Call the image export setup dialog
Ctrl+Q	Command+Q	Quit the program
Ctrl+Z	Command+Z	Undo

For Windows and Linux	For macOS	Effect
Ctrl+Y	Command+Y	Redo

F1 — open the help System;

F11 — switch to the full screen mode and exit from it;

Esc — exit from the full screen mode.

## Key Combinations Used in Image View Window

For Windows and Linux	For macOS	Effect
Alt+Delete	fn+option+Backspace	Delete markers and measurements
MW	Scrolling	Switch from slice to slice
Shift+LMB	Shift+LMB	Browse images (forward)
Ctrl+LMB	Command+LMB	Browse images (back)
move the mouse holding RMB	move the mouse holding RMB	Edit W/L
Ctrl+MW	Command+Scrolling	Zoom
Shift+MMB		Drag the image
RMB	RMB	Call the context menu
Ctrl+E	Command+E	Call the image export setup dialog

[ — switch to previous image;

] — switch to next image;

H — mirror image horizontally;

V — mirror image vertically;

K — activate the tool Marker;

N — activate the tool Line marker;



- 
- I — activate the tool Rotate;
  - Z — activate the tool Image scaling;
  - M — activate the tool Image shift;
  - W — activate the tool Adjust W/L;
  - A — activate the tool Arrow tool;
  - T — activate the tool Text tool;
  - O — activate the tool Polygon tool;
  - E — activate the tool Ellipse tool;
  - R — activate the tool Ruler;
  - C — activate the tool Angle;
  - B — activate the tool Kobb angle;
  - P — activate the tool Point value;
  - L — activate the tool ROI rectangle;
  - Q — activate the tool ROI ellipse;
  - G — activate the tool ROI polygon;
  - Y — activate the tool DSA;
  - Shift+A — switch the projection to axial;
  - Shift+C — switch the projection to coronal;
  - Shift+S — switch the projection to sagittal;
  - F5 — export the image with the latest settings.

## Key Combinations Used in 3D Reconstruction Window

For Windows and Linux	For macOS	Effect
MW, Ctrl+MMB	Scrolling	Zoom
Shift+MMB		Drag the model
Alt+MMB	Alt+MMB	Center the model
MMB	Option+LMB	Rotate the model

For Windows and Linux	For macOS	Effect
<b>Key combinations for Clipping Box tool</b>		
Ctrl+holding the mouse button with which the tool was activated	Command+holding the mouse button with which the tool was activated	Zoom the Clipping Box symmetrically
Shift+holding the mouse button with which the tool was activated	Shift+holding the mouse button with which the tool was activated	Pan the Clipping Box
Alt+holding the mouse button with which the tool was activated	Option+holding the mouse button with which the tool was activated	Rotate the Clipping Box

- I — activate the tool Model rotation;
- Z — activate the tool Model scaling;
- M — activate the tool Model shift;
- C — activate the tool Polygon cut;
- T — activate the tool Remove table;
- W — activate the tool Adjust W/L;
- B — activate the tool Clipping box;
- J — activate the tool Ruler;
- K — activate the tool Marker;
- N — activate the tool Line marker;
- P — activate the tool Select model point;
- F5 — export the image with the latest settings.

---

## Key Combinations Used in DICOM Tag View Window

For Windows and Linux	For macOS	Effect
Ctrl+F	Command+F	Open the search panel
Esc	Esc	Close the search panel
Ctrl+C	Command+C	Copy the selected cell

## Key Combinations Used in Curvilinear Reconstruction Mode

For Windows and Linux	For macOS	Effect
Ctrl+LMB on a curve	Command+LMB on a curve	Jump to the surface the point is located on
Shift+drag the mouse holding LMB	Shift+drag the mouse holding LMB	Drag the curve
RMB on a curve	RMB on a curve	Context menu

## Key Combinations Used in Multiplanar Reconstruction Window

For Windows and Linux	For macOS	Effect
Ctrl+MW	Command+Scrolling	Zoom
Shift+MMB		Drag the image
MW	Scrolling	Switch from slice to slice

Left, Right, Forward, Back — move planes;

F5 — export the image with the latest settings;

- Z — activate the tool Model scaling;
- M — activate the tool Model shift;
- K — activate the tool Marker;
- N — activate the tool Line marker;
- J — activate the tool Ruler;
- O — activate the tool Polygonal ruler;
- C — activate the tool Angle;
- B — activate the tool Kobb angle;
- P — activate the tool Point value;
- L — activate the tool ROI rectangle;
- Q — activate the tool ROI ellipse;
- G — activate the tool ROI polygon.

## Key Combinations Used in Virtual Endoscopy Window

For Windows and Linux	For macOS	Effect
LMB in the navigation menu	LMB in the navigation menu	Set the camera position
MMB		Rotate the camera
Shift+MMB		Drag the camera
MW	Scrolling	Zoom
RMB	RMB	Context menu

- Left, Right — rotate the object relative to the camera axis;
- Forward, Back — move the object along the camera axis;
- R — activate the tool Ruler;
- K — activate the tool Marker;
- N — activate the tool Line marker.

# Index

3D Reconstruction ..... see Volume  
Reconstruction

## A

AIP ..... 279  
Anonymize ..... 467  
Arrangement  
  of Images ..... 454  
Axial section ..... 204, **252**

## B

Brightness ..... 108

## C

Camera Orientation ..... 399  
Cardiac function analysis ..... **368**  
Clipping Box ..... 214  
Closing ..... 212  
CLUTs ..... 165  
Command Line Keys ..... 30  
Command Line Options ..... 498  
Contrast ..... 108  
Coronal section ..... **252**  
Curved MPR ..... 260  
Cut invisible volume ..... 212

## D

DICOM Printer ..... 493  
DICOM Service ..... 423  
DICOM Tags ..... 192  
DICOM tags ..... 464  
Diffusion Tensor Imaging ..... 285  
Digital Subtraction Angiography ..... 188  
Dilation ..... 212  
Disk Creator ..... 63, 79, **440**  
  Adding viewer to image ..... 442  
  Write to Disc in Linux and macOS . 445  
  Write to Disk ..... 443  
  Write to Memory card ..... 444  
Display mode  
  of images

  custom ..... 100  
  grid ..... 100  
  stacked ..... 100  
of series  
  auto ..... 96  
  custom ..... 98, 99  
  grid ..... 97  
  stacked ..... 97  
DSA ..... 188  
DTI ..... 285

## E

ECG ..... 63  
ECG Viewer ..... 63, **402**  
Edit  
  Patient Name ..... 75  
  Study Description ..... 75  
Erosion ..... 212  
Export surface ..... 311

## F

Fill ..... 212  
Frequency Filters ..... 407  
Frontal section ..... 204  
Full Screen Mode ..... 56, **60**, 60, 512  
Fusion ..... 62, **230**

## G

glb ..... 311  
Grow ..... 212  
Grow bones ..... 227

## H

Help System ..... 509  
Hotkeys ..... 459, **511**

## I

Image annotation ..... **409**  
Image Filters ..... 89  
Image registration ..... 241  
Import surface ..... 313

- Importing a Structure from DICOM RT .. 317  
 Installing ..... 30
- J**  
 jpg ..... 186
- L**  
 Label ..... 197  
 Launching ..... 30  
 Launching the Program ..... 47  
 Launching the Web Viewer ..... 52  
 Leads ..... 404  
 License ..... 507, **508**  
 Local Storage ... 62, **67**, 79, 438, 447, 456
- M**  
 Maximum Intensity Projection ..... 278  
 Merge layers ..... 233  
     automatically ..... 236  
     by point ..... 237  
     manually ..... 237  
 Minimum Intensity Projection ..... 278  
 MinIP ..... 278  
 MIP ..... 278  
 MPR ..... see Multiplanar Reconstruction  
 Multi-monitor Window Design ..... 450  
 Multi-segment Growing ..... 212, **328**  
 Multiplanar Reconstruction .. 231, 233, **251**,  
     **398**, 515  
     3D Cursor Mode ..... 257  
     Build Surface ..... 260  
     Curvilinear Reconstruction ..... 260  
     Cutting Plane Mode ..... 257  
     Export ..... 281  
     Line Markers ..... 276  
     Markers ..... 275  
     Mirror Image Horizontally and  
         Vertically ..... 280  
     Orthogonal Planes ..... 256  
     Polygonal Line Markers ..... 276  
     Reslice ..... 281  
     Rotate Image ..... 279  
     Rotate Planes ..... 257  
     Slice Thickness ..... 278  
 Multiplanar reconstruction ..... 62
- N**  
 NETWORK ..... 502–504  
 Network ..... **423**, 436
- O**  
 obj ..... 311, 366  
 Opening ..... 212  
 Opening DICOM studies by dragging  
     and dropping ..... 65  
 Opening DICOM studies from the context  
     menu ..... 66  
 Opening Segmentation Projects ..... 340  
 Opening Zipped DICOM Studies ..... 65  
 Orientation Cube ..... 191
- P**  
 PACS Server ..... 73, **429**  
 pdf ..... 63  
 Perfusion Scoring ..... 126  
 PET ..... 62  
 PET analysis ..... **379**  
 ply ..... 311, 366  
 png ..... 186  
 Print Images ..... **484**  
     by default ..... 495  
     Export ..... 497  
     on Films ..... 496  
     on Paper ..... 497  
     Page template ..... 489  
 Print images  
     Reference Image ..... 492  
 Product Registration ..... 507  
 Projection ..... 204
- R**  
 Region Growing ..... 322  
 Remove holes ..... 212  
 Remove noise ..... 212  
 Rendering transfer function ..... 167  
 Report editor ..... **471**  
 ROI  
     ellipse ..... 121  
     polygon ..... 121
- S**  
 Sagittal section ..... 204, **252**  
 Saving Segmentation Projects ..... 340  
 Scout lines ..... 180  
 Search ..... 64, **70**  
 Segmentation ..... 292  
     Intersection of structures ..... 333  
     Mask ..... 299  
     Subtraction structures ..... 332

- Unification of structures ..... 331
  - Setting
    - CLUTs ..... 165
    - Render settings ..... 222
    - Scout lines ..... 181
    - Visualization ..... 164
    - Workspace ..... 182
  - Settings ..... 446
    - Export ..... 462
    - Import ..... 462
    - Import CLUTs ..... 462
    - Modules ..... 454
    - Monitor ..... 450
  - Shrink ..... 212
  - Skins ..... 453
  - Sort studies ..... 74
  - Split Screen ..... 86
  - Stitching Mode ..... 247
  - stl ..... 311, 366
  - Storage ..... 62, **67**, 79, 438, 447, 456
  - Structure Export ..... 315, 316
  - Structure Export to DICOM RT ..... 316
  - Study List Export ..... 77
  - Surface ..... 306, 309
  - SUV ..... 172
  - Switch between Series ..... 93
  - Synchronize Images ..... 198
  - System Requirements ..... 30
- T**
- Tab ..... 58
  - Tab display mode ..... **56**, 60, 63
  - Technical Support ..... 17
  - Tooltips ..... 510
- U**
- Uncompress series ..... 80
  - Uninstalling ..... 30
- V**
- Vessel analysis ..... **352**
  - Vessel Tree Segmentation ..... 324
  - Vessels ..... 62
  - View Flat Images ..... **82**, 512
    - ADC ..... 202
    - Calibration Sizes ..... 200
    - Export ..... 184
    - Graphic Label Tool ..... 194
    - Mirror Image Horizontally and Vertically ..... 200
  - View flat images
    - Angle ..... 118
    - cardiothoracic ratio measurements 122
    - Cobb angle meter ..... 118
    - Delete Measurements ..... 124
    - distance measurement on US
      - studies ..... 125
    - Drawing Parameters ..... 123
    - Intensity at a Point ..... 120
    - Intensity Average ..... 121
    - magnifier ..... 115
    - measurement of blood flow velocity
      - on US studies ..... 125
    - measuring angles between intersecting rulers ..... 117
    - Move Measurements ..... 124
    - Move Measurements Results ..... 124
    - pan ..... 107
    - play ..... 104
    - Polygonal Ruler ..... 117
    - rotate ..... 108
    - Ruler ..... 116
    - Standard Deviation in an Area ..... 121
    - time lapse measurement on US
      - studies ..... 125
    - video recording ..... 105
    - zoom ..... 107
  - View Several
    - Images at a Time ..... 100
    - Series at a Time ..... 95
    - Studies at a Time ..... 93
  - Virtual Endoscopy ..... **231**, **393**, 516
    - Camera Fly ..... 396
    - Customize MPR Navigation Panel . 395
    - Export ..... 401
    - Measurements and Markers ..... 398
    - Move Camera
      - Automatically ..... 396
      - Manually ..... 396
    - Surface Reconstruction ..... 399
  - Virtual endoscopy ..... 62
  - Visualization
    - CPU ..... 456
    - CUDA ..... 203, **456**
    - Metal ..... 203, 306, **456**
    - OpenCL ..... 203, **456**

Volume Reconstruction ..... **203**, 231, 513

- 3D Angle ..... 219
- Center ..... 213
- Delete All Areas except Selected
  - Area ..... 209
- Delete Area ..... 209
- Delete Table ..... 213
- Export Rotation to Series ..... 221
- Inverse Polygon Cut ..... 209
- Markers ..... 221
- play ..... 207
- Polygon Cut ..... 209
- Polygonal Ruler ..... 216
- Remove Bone Tissue ..... 225
- Rotation ..... 206
- Ruler ..... 215
- Scaling ..... 207
- Shift ..... 206
- Sphere Cut ..... 210
- Sphere Restore ..... 210
- Surface ruler ..... 217

Volume reconstruction ..... 62

Volume stitching ..... 248

**W**

Window Level ..... 108

Window Width ..... 108



# Glossary

**editing mask** — a template that restricts the structure mask. The editing mask is defined by the CLUTs. [301](#)

**multiphase series** — series contained more than one phase. [186](#), [244](#)

**phase** — image group with different location. If the study contains images of the same body part taken at intervals (for example, contrast studies), then images with different locations are grouped into phases and sorted according to the time taken to create the image. [186](#), [244](#)

**structure** — part of the volume defined by the mask or surface. [292](#)

**structure mask** — voxel volume obtained as a result of segmentation. [300](#)

**voxel** — element of a 3D image containing the value of a raster element in 3D space. [227](#)

---

Thanks for selecting our product! The Inobitec Software FZ-LLC team is constantly working to improve it. We will be grateful for any feedback, comments and suggestions how to enhance the product functionality, user-friendliness and visualization quality.

**We wish you success in your work!**